

### 3-Way Kit Installation

#### For Incandescent/Halogen Lighting use an Incandescent/Halogen Dimmer.

MAW-603 600 W 120 V~ 60 Hz

#### Accessory Dimmer

MAW-R 8.3 A 120 V~ 60 Hz

#### For Magnetic Low-Voltage Lighting use a Magnetic Low-Voltage Dimmer ONLY.

Purchase Separately.

#### For Electronic Low-Voltage Lighting use an Electronic Low-Voltage Dimmer ONLY.

Purchase Separately.

#### Important Notes

Please read before installing.

- Caution:** To avoid overheating and possible damage to other equipment, do not use to control receptacles, fluorescent lighting fixtures, motor-operated or transformer-supplied appliances.
- Install in accordance with all national and local electrical codes.
- DO NOT** use *Maestro* dimmers for compact fluorescent (Energy Saver) lamps.
- When no "grounding means" exist within the wallbox then the NEC® 2005, Article 404-9 allows a dimmer without a grounding connection to be installed as a replacement, as long as a plastic, noncombustible wallplate is used. For this type of installation, cap or remove the green ground wire on the dimmer and use an appropriate wallplate such as Lutron's *Claro* series wallplates.
- Do not paint Dimmers or *Maestro* Accessory Dimmers (MAW-R).
- Maestro* Dimmers are NOT compatible with standard 3-way switches. Use only with the *Maestro* Accessory Dimmers (MAW-R).
- Do not use where total lamp wattage is less than 40 W or greater than 600 W (see Dimmer Capacity chart for details).
- Operate between 32 °F (0 °C) and 104 °F (40 °C).
- It is normal for Dimmer to feel warm to the touch during operation.
- Recommended minimum wallbox depth is 2.5" (64 mm).
- Maximum wire length between the Dimmer and the *Maestro* Accessory Dimmer (MAW-R) is 250' (76 m).
- Clean dimmer with a **soft damp cloth only**. Do not use any chemical cleaners.
- DO NOT** use Incandescent/Halogen or Electronic Low-Voltage dimmers for Magnetic Low-Voltage lighting.

### Multigang Installations

When installing more than one control in the same wallbox, it may be necessary to remove all inner side sections prior to wiring (see below). Using pliers, bend side sections up and down until they break off. Repeat for each side section to be removed. Removal of Dimmer side sections reduces maximum load capacity. Refer to chart below for maximum Dimmer capacity.

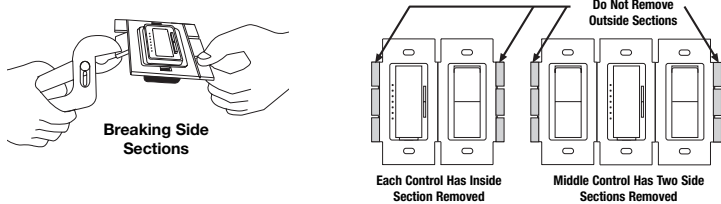

	Dimmer Capacity		
	No Sides Removed	1 Side Removed	2 Sides Removed
<b>MAW-603</b>	600 W	500 W	400 W

### Technical Assistance

Let us help with the installation or operation of your MAW-603 and MAW-R. Please call the **Lutron Technical Support Center.**

**U.S.A. and Canada (24 hrs/7 days)**  
1-800-523-9466

**Other countries 8am – 8pm ET**  
+1-610-282-3800

**Fax +1-610-282-6311**

<http://www.lutron.com>

### Limited Warranty (Valid only in U.S.A., Canada, Puerto Rico, and the Caribbean.)

Lutron will, at its option, repair or replace any unit that is defective in materials or manufacture within one year after purchase. For warranty service, return unit to place of purchase or mail to Lutron at 7200 Suter Rd., Coopersburg, PA 18036-1299, postage pre-paid.

**THIS WARRANTY IS IN LIEU OF ALL OTHER EXPRESS WARRANTIES, AND THE IMPLIED WARRANTY OF MERCHANTABILITY IS LIMITED TO ONE YEAR FROM PURCHASE. THIS WARRANTY DOES NOT COVER THE COST OF INSTALLATION, REMOVAL OR REINSTALLATION, OR DAMAGE RESULTING FROM MISUSE, ABUSE, OR DAMAGE FROM IMPROPER WIRING OR INSTALLATION. THIS WARRANTY DOES NOT COVER INCIDENTAL OR CONSEQUENTIAL DAMAGES. LUTRON'S LIABILITY ON ANY CLAIM FOR DAMAGES ARISING OUT OF OR IN CONNECTION WITH THE MANUFACTURE, SALE, INSTALLATION, DELIVERY, OR USE OF THE UNIT SHALL NEVER EXCEED THE PURCHASE PRICE OF THE UNIT.**

This warranty gives you specific legal rights, and you may have other rights which vary from state to state. Some states do not allow the exclusion or limitation of incidental or consequential damages, or limitation on how long an implied warranty may last, so the above limitations may not apply to you. This product is covered under one or more of the following U.S. patents: 4,835,343; 5,248,919; 5,399,940; 5,637,930; 5,798,581; D353,798 and corresponding foreign patents. U.S. and foreign patents pending. Lutron, Claro and Maestro® are registered trademarks and FASS is a trademark of Lutron Electronics Co., Inc. NEC is a registered trademark of the National Fire Protection Association, Quincy, Massachusetts. © 2006 Lutron Electronics Co., Inc.

**LUTRON®**

Lutron Electronics Co., Inc.  
7200 Suter Road  
Coopersburg, PA 18036-1299, U.S.A.  
Made and printed in the U.S.A. 12/06 P/N 030-885 Rev. B

## Operation

#### Tap Button Options

- Tap once when unit is off** - Lights brighten smoothly to preset intensity.
- Tap once when unit is on** - Lights dim smoothly to off.
- Tap twice quickly** - Lights brighten rapidly to full intensity.
- Press and hold when unit is on** - Each time dimmer is turned off delayed fade to OFF can be activated. As the tap button is held, the LEDs will begin to flash. The first flashing LED represents a 10 second fade to OFF. Each additional flashing LED represents an additional 10 seconds of delay before lights fade to OFF (up to 60 seconds of delay).

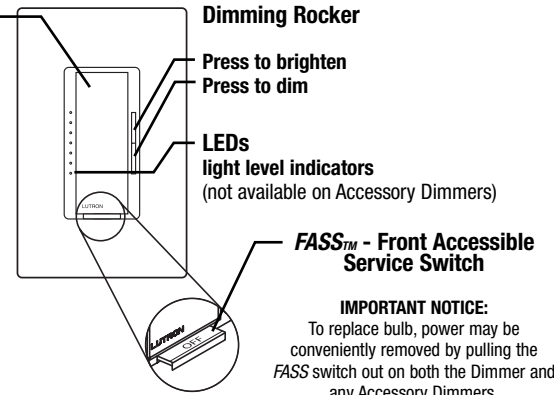

#### IMPORTANT NOTICE:

To replace bulb, power may be conveniently removed by pulling the FASS switch out on both the Dimmer and any Accessory Dimmers.

**For any procedure other than routine bulb replacement, power must be disconnected at the main electrical panel.**

To learn about the **Advanced Features** of *Maestro* Dimmers including locked preset and adjustable fade times, please visit:  
<http://www.lutron.com/maestro/advfeatures>  
or call the **Lutron Technical Support Center.**



030-885



030-885

## Troubleshooting

Symptom	Possible Cause
Light does not turn ON or no LEDs turn ON.	<ul style="list-style-type: none"> <li>Front Accessible Service Switch (FASS) on Dimmer or Accessory Dimmer is pulled out to the OFF position.</li> <li>Light bulb(s) burned out.</li> <li>Breaker is OFF or tripped.</li> <li>Wiring error. Call <b>Lutron Technical Support Center.</b></li> </ul>
Light turns ON and Dimmer works, but Accessory Dimmer does not work.	<ul style="list-style-type: none"> <li>Wire connected to the blue screw terminal on Dimmer is not the same wire connected to the blue screw terminal on Accessory Dimmer.</li> </ul>
Light does not remain ON, LEDs glow dimly or blink.	<ul style="list-style-type: none"> <li>Blue screw terminal miswired to neutral wire or touching ground.</li> </ul>
Tap switch on Accessory Dimmer does not work at brightest level.	<ul style="list-style-type: none"> <li>Load is less than 40 W.</li> </ul>

# Installation

## 1 Turning OFF power.

- Turn power OFF at circuit breaker (or remove fuse).

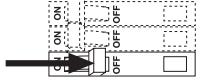

## 2 Removing wallplates and switches.

- Remove the wallplate and switch mounting screws.
- Carefully remove switch from wall (**do not remove wires**).

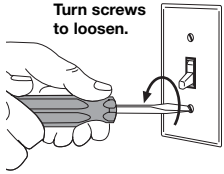

**Danger:** Verify power to switch is OFF before proceeding.

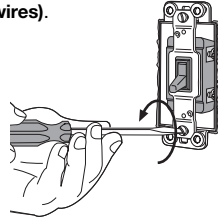

## 3 Tagging the wire on the "COMMON" terminal of the switches.

- Before removing wires from the switch you must identify the COMMON terminal.

### 3-Way Switch

The "COMMON" terminal is the different colored screw (not green) or the terminal marked "COMMON." Tag this wire on each switch to identify it in Step 5.

**Note:** If more than 2 switches control the same light, additional Accessory Dimmers are required. Please call the Lutron Technical Support Center for details.

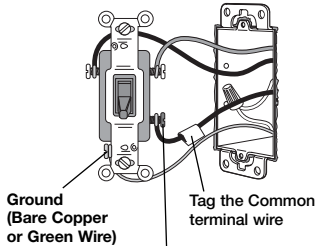

**NOTE:** This is a typical location of the Common terminal, but your switch may be different.

## 4 Disconnecting switch wires.

**Important Note:** Your wall switch may have two wires attached to the same screw (see illustrations below for examples). Tape these two wires together before disconnecting. When wiring, connect wires to the Dimmer the same way they were connected to the switch.

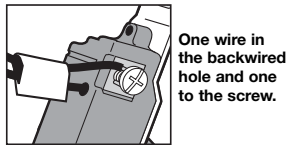

One wire in the backwire hole and one to the screw.

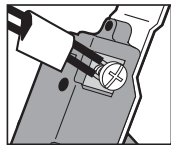

One continuous wire to the screw.

**Screw Terminals:** Turn screws to loosen.

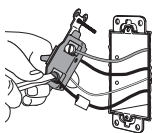

**Push-in Terminals:** Insert screwdriver. Pull wire out.

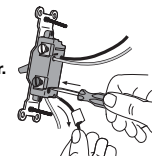

**Looped Wire:** Turn screw to loosen.

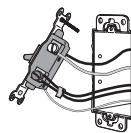

## Important Wiring Information

When making wire connections, follow the recommended strip lengths and combinations for the supplied wire connector. **Note:** All wire connectors provided are suitable for **copper wire only**. For aluminum wire, consult an electrician.

**Wire Connector:** Use to join one 14 AWG or 12 AWG ground wire with one 18 AWG dimmer ground wire.

Trim or strip wallbox wires to the length indicated by the strip gauge on the back of the dimmer

**Push-in Terminals:** Insert wires fully. **NOTE:** Push-in terminals are for use with #14 AWG **solid copper wire only**. DO NOT use stranded or twisted wire.

OR

**Screw Terminals:** Tighten securely. Screw terminals are for use with #12 or #14 AWG **solid copper wire only**. DO NOT use stranded or twisted wire.

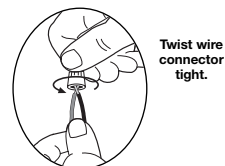

Twist wire connector tight.

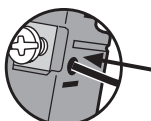

## 5 Wiring.

- For installations involving more than one control in a wallbox, refer to Multigang Installations before beginning.
- Use the screw or push-in terminals when making connections on the Dimmer or Accessory Dimmer.
- Wire both controls before mounting.



Dimmer and Accessory Dimmer have a pre-installed Lutron *Claro* wallplate. Remove the wallplate before proceeding with installation. This will expose mounting holes in adapter, and prevent wallplate damage while installing.



Grasp *Claro* wallplate at top and pull forward to remove.

### 3-Way Wiring

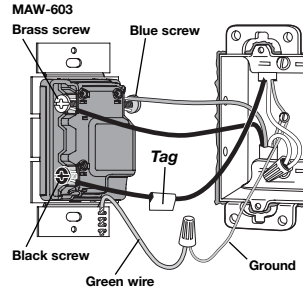

### Wiring the Dimmer (MAW-603):

- Using the wire connector provided, connect the **green** ground wire on the Dimmer to the **bare copper** or **green** ground wire in the wallbox.
- Connect the tagged wire removed from the switch to the **black** screw terminal on the Dimmer.
- Connect one of the remaining wires removed from the switch to the **brass** screw terminal on the Dimmer.
- Connect the remaining wire removed from the switch (note wire color) to the **blue** screw terminal on the Dimmer.

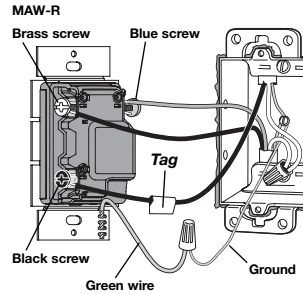

### Wiring the Accessory Dimmer (MAW-R):

- Using the wire connector provided, connect the **green** ground wire on the Accessory Dimmer to the **bare copper** or **green** ground wire in the wallbox.
- Connect the tagged wire removed from the switch to the **black** screw terminal on the Accessory Dimmer.
- Connect the same color wire connected to the **blue** screw terminal on the Dimmer (wire color noted above) to the **blue** screw terminal on the Accessory Dimmer.
- Connect the remaining wire removed from the switch to the **brass** screw terminal on the Accessory Dimmer.

### Reference Wiring Diagram

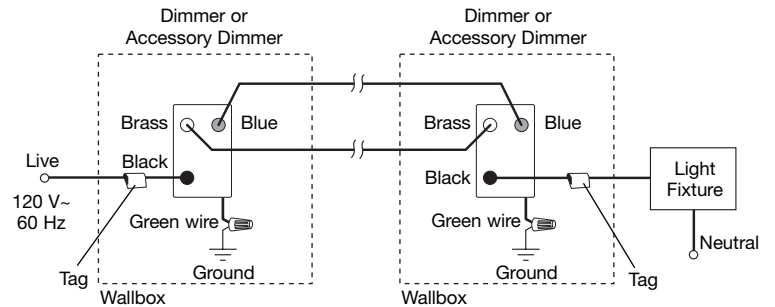

## 6 Mounting dimmer to wallbox.

- Form wires carefully into the wallbox, mount and align Dimmer (and Accessory Dimmers).
- Replace *Claro* wallplate(s).



Align dimmer and tighten screws.



**Caution:** Do not overtighten mounting screws.

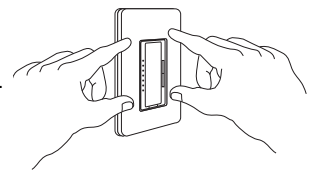

Snap on wallplate.

## 7 Turning ON power.

- Turn power ON at circuit breaker (or replace fuse).

