

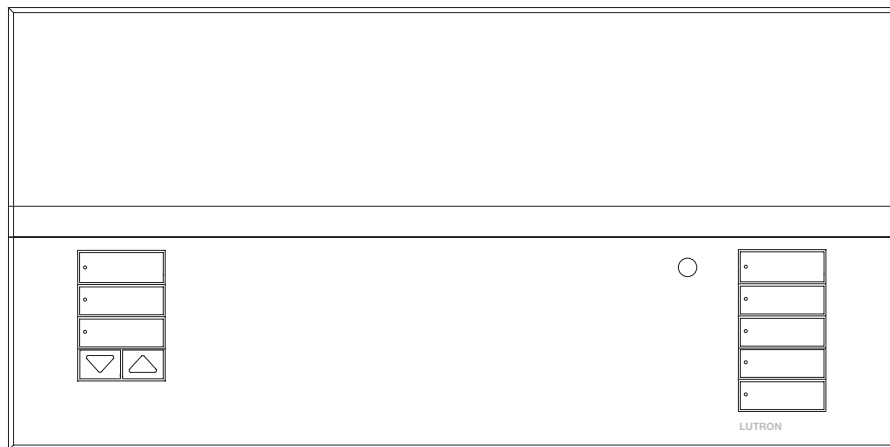

GRAFIK Eye® QS Control Unit

Installation and Operation Guide

Please Read



The GRAFIK Eye® QS control unit allows for control of both lights and window treatments, without interfaces, using a single control unit. Features include pushbutton scene recall, info screen that displays energy savings and status, IR receiver, astronomic timeclock, contact closure input, and engravable backlit buttons that are easy to find and operate.

Model Numbers: QSGR-3PCE, QSGR-4PCE, QSGR-6PCE
QSGRK-3PCE, QSGRK-4PCE, QSGRK-6PCE
QSGRM-3PCE, QSGRM-4PCE, QSGRM-6PCE
QSGRN-6PCE, QSGRQ-6PCE

All units 230 V \sim 50/60 Hz

	QSGR-3PCE QSGRK-3PCE QSGRM-3PCE	QSGR-4PCE QSGRK-4PCE QSGRM-4PCE	QSGR-6PCE QSGRK-6PCE QSGRM-6PCE QSGRN-6PCE QSGRQ-6PCE
Unit Capacity (watts)	1 500 W	2 000 W	2 300 W
MLV	1 500 VA / 1 200 W	2 000 VA / 1 600 W	2 300 VA / 1 800 W
Zone Capacity (watts)	40 – 500 W	40 – 500 W	40 – 500 W
MLV	40 – 500 VA / 40 – 400 W	40 – 500 VA / 40 – 400 W	40 – 500 VA / 40 – 400 W

See page 8 for IEC PELV/NEC® Class 2 ratings.

Contents

Features and Functions of the GRAFIK Eye® QS Control Unit	3	Contact Closure Input (CCI) Setup		Timeclock Operation	
Wiring the GRAFIK Eye® QS Control Unit		CCI Mode Settings	24	Setting Time and Date	50
Overview of Line Voltage/Mains Wiring	4	CCI Type Settings	25	Setting Location	51
Line Voltage Wiring Details	5	Occupancy Sensor Setup	26	Setting Daylight Saving Time	51
Overview of IEC PELV/NEC® Class 2 Wiring	7	Associating Wireless Occupancy Sensors	27	Adding an Event	52
QS Link Control Wiring Details	8	Selecting the Mode	28	Deleting an Event	53
Power Group Wiring Example	9	Scene Mode	29	Viewing an Event	53
Powering More Than 3 Wallstations Example	10	Zone Mode	30	Setting a Holiday	54
Completing Installation of the GRAFIK Eye® QS Control Unit	11	Labeling an Occupancy Sensor (optional)	31	Viewing a Holiday	54
General Functionality	12	Configuring Occupancy Sensor Settings (optional)	32	Deleting a Holiday	54
Pre-Programmed Button Functionality	13	Daylight Sensor Setup	33	Copying a Schedule	55
Zone Button Operation		Associating Wireless Daylight Sensors	34	Deleting a Schedule	55
Zone LED Displays for % of Lighting Levels	14	Assigning Sensors	35	Afterhours	56
Programming Mode		Labeling a Daylight Sensor (optional)	36	Afterhours Examples	57
Entering and Exiting Programming Mode	15	Pico® Wireless Control Setup	37	Setting Up Afterhours	58
Navigating Menus in Programming Mode	15	Associating with a GRAFIK Eye® QS Wireless Control Unit	38	Ending Afterhours	58
Wireless Mode	16	Associating through a QS Sensor Module	39	Diagnostics and Special Settings	
Zone Setup		IR Setup	40	Enabling/Disabling the Timeclock	59
Assigning Load Types	17	Enabling/Disabling the IR Receiver	41	Enabling/Disabling the Backlighting	59
Assigning Non-Dim Load Type	17	Associating the QS IR Eye with a GRAFIK Eye® QS Control Unit	42	Diagnostics	59
Setting Load Types	18	Associating through a QS Sensor Module	44	Setting the Security Password	60
Setting High End or Low End Trim	19	Associating Sivoia® QS Window Treatments and GRAFIK Eye® QS Control Units	45	Language Selection	61
Setting Minimum Level (optional)	19	Adjusting Window Treatment Settings		Faceplate Removal	61
Labeling a Zone (optional)	20	Setting Limits	46	Troubleshooting	62
Scene Setup		Preset Adjustment: Simple Method	47	Troubleshooting: Wireless Functions	63
Setting Zone Levels, Fade Rates, and Window Treatment Group Actions	21	Preset Adjustment: Advanced Method	47	Troubleshooting: Window Treatment Functions	64
Labeling a Scene (optional)	22	Naming a Group of Window Treatments	48	Warranty	65
Enabling/Disabling Daylighting in a Scene	22	Associating Multiple GRAFIK Eye® QS Control Units	49	Contact Information	65
Setting Save Mode					
Save Mode Settings	23				
Quick Scene Programming: Save by OK Mode	23				

Features and Functions of the GRAFIK Eye® QS Control Unit

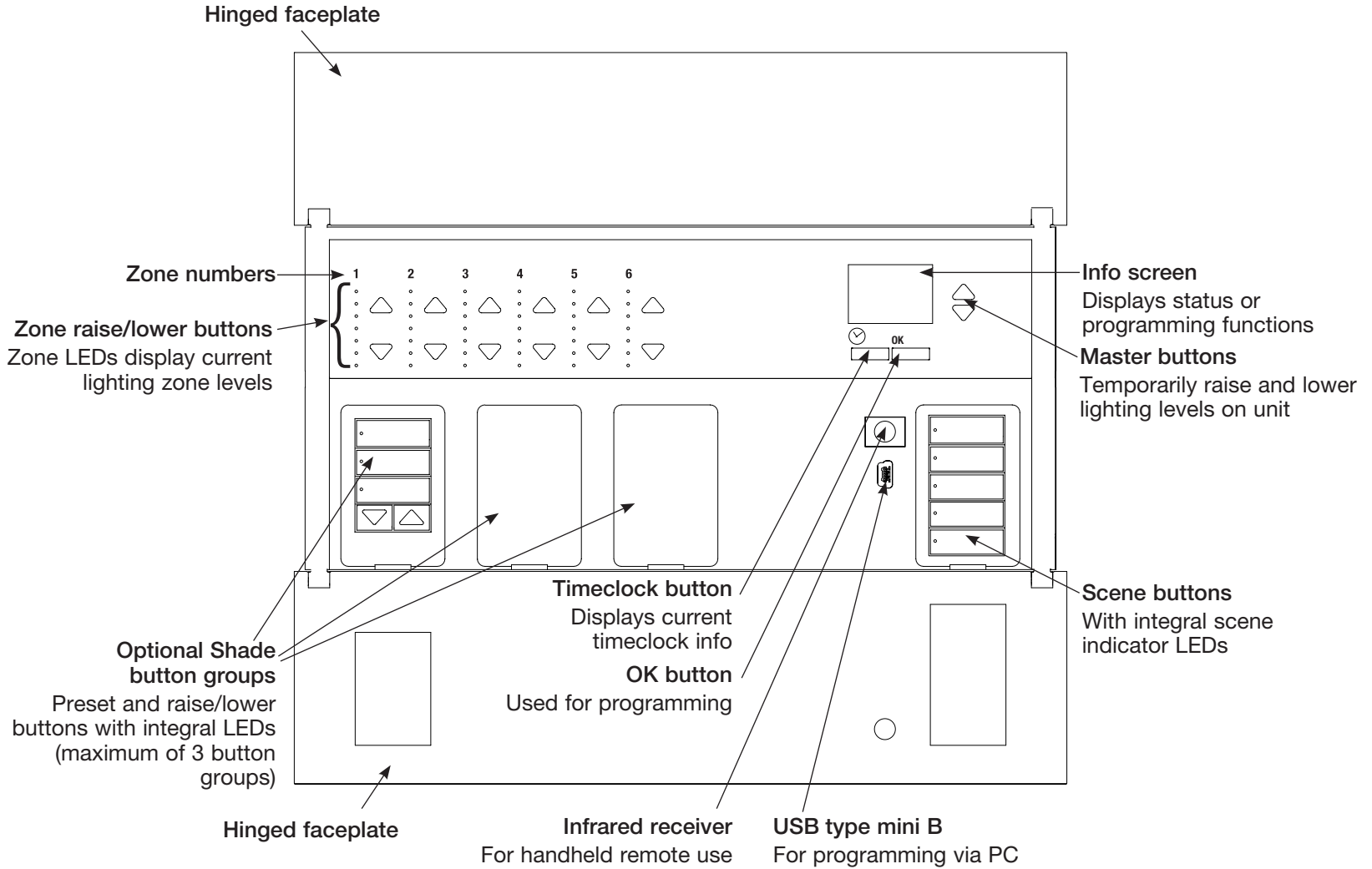

Wiring the GRAFIK Eye® QS Control Unit: Overview of Line Voltage/Mains Wiring

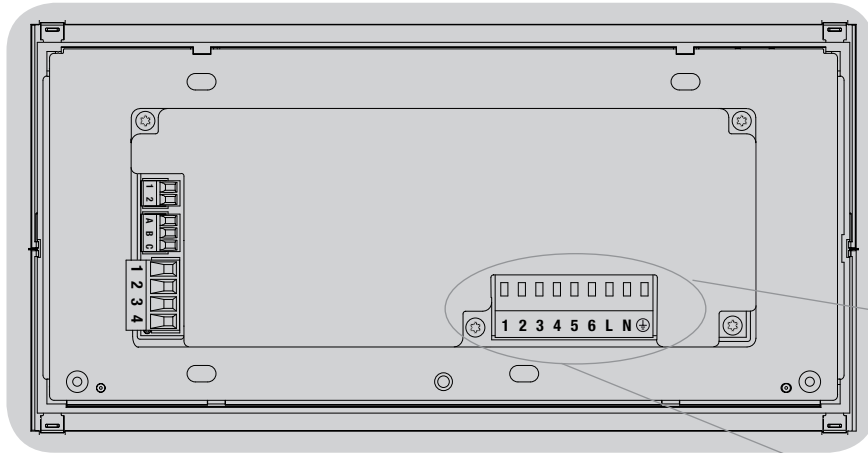

Line Voltage/Mains Cables and Load Wiring

Terminal labels:

L: Hot/Live

N: Neutral

⊕: Ground

1-6: Dimmed/Switched
line voltage outputs

4.0 mm² each
terminal

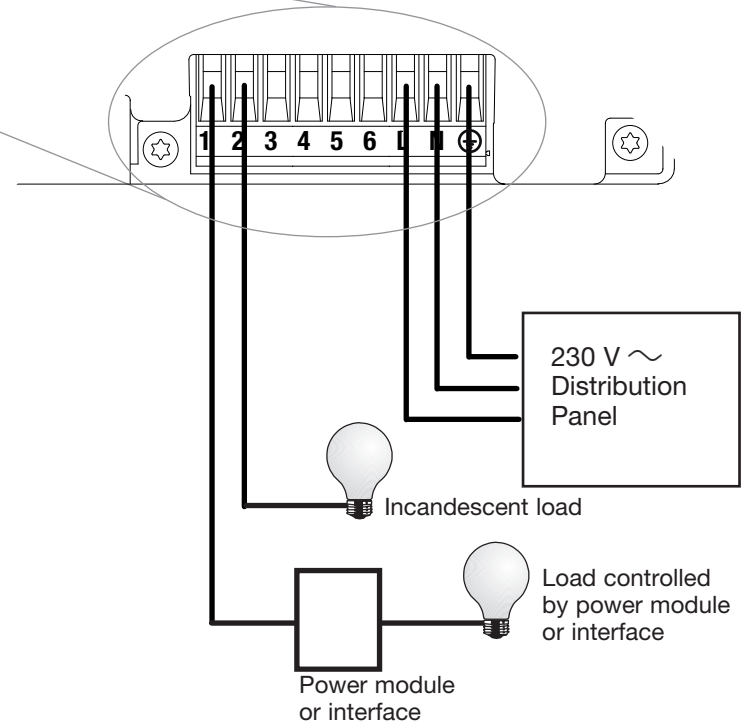

Wiring the GRAFIK Eye® QS Control Unit: Line Voltage Wiring Details

- Use properly certified cable for all line voltage/mains cables.
- Proper short-circuit and overload protection must be provided at the distribution panel. You can use up to a 20 A circuit breaker for your installation.
- Install in accordance with all local and national electrical codes.
- IEC PELV/NEC® Class 2 terminals may be temporarily unplugged for ease of IR, occupancy sensor, and control wiring.
- **Notice: Risk of damage to unit.** Do not connect line voltage/mains cable to IEC PELV/NEC® Class 2 terminals.

Step 1: Install wallbox. Mount an 89 mm deep 4-gang U.S. wallbox on a dry, flat indoor surface that is accessible and allows for system programming and operation. Allow at least 110 mm clearance above and below the faceplate to ensure proper heat dissipation. Allow 25 mm for faceplate overhang on all sides.

Note: 4-gang wallbox available from Lutron; P/N 241400.

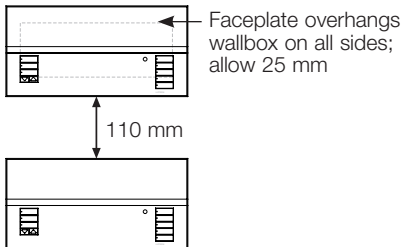

Step 2: Test load wiring.

- Turn power OFF at the circuit breaker or fuse box.
- Connect a standard light switch between the live lead and load wire to test the circuit.
- Turn power ON and check for short or open circuits. If load does not operate, the circuit is open. If the circuit breaker trips (fuse blows or opens), a load short may exist. Correct short or open circuits and test again.

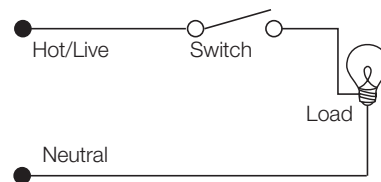

Step 3: Check control unit wiring.

- Earth/ground terminal connection must be made as shown in line voltage wiring diagrams.
- Do not mix different load types on the same zone.
- Follow all local and national electrical codes when installing IEC PELV/NEC® Class 2 wiring with line voltage/mains wiring.



WARNING! Shock hazard. May result in serious injury or death. Always turn off circuit breaker or remove main fuse from power line before doing any work. Before connecting the loads to the GRAFIK Eye® QS control unit, test the loads for short-circuits.

Wiring the GRAFIK Eye® QS Control Unit: Line Voltage Wiring Details (continued)

Step 4: Connect line voltage and loads to control unit.

- Strip 8 mm of insulation off the line voltage/mains cables in the wallbox.



- Connect the line voltage/mains, ground, and load wires to the appropriate terminals on the back of the control unit.

L: Hot/Live

N: Neutral

: Ground

Terminals 1-6: Dimmed/Switched
line voltage outputs

The recommended installation torque is 0.6 N·m for line voltage/mains connections and 0.6 N·m for the earth/ground connection.

Note: See the zone setup section for a list of compatible load types and instructions for programming the GRAFIK Eye® QS control unit to properly recognize them.

Notice: Risk of damage to unit. GRAFIK Eye® QS control units must be installed by a qualified electrician in accordance with all applicable regulations and building codes. Improper wiring can result in damage to control units or other equipment.

Note: To avoid overheating and possible damage to equipment, do not install control units to dim receptacles, motor-operated appliances, or fluorescent lighting not equipped with Lutron Hi-lume®, Eco-10®, Tu-Wire®, electronic dimming ballasts, or other devices approved for your location. In dimmed magnetic low-voltage circuits, you can prevent transformer overheating and failure by avoiding excessively high current flow. Do not operate control units with any lamps removed or burned out; replace any burned out lamps immediately; use only transformers that incorporate thermal protection or fused primary windings. Control units are designed for residential and commercial use, for indoor use only.

Wiring the GRAFIK Eye® QS Control Unit: Overview of IEC PELV/NEC® Class 2 Wiring

IR Wiring

1.0 mm² each terminal
From external IR connection (by others)

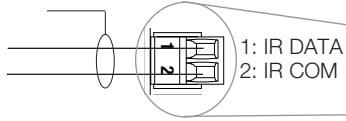

Contact Closure Input Wiring

24 V⁼⁼ 50 mA
For settings, see CCI Mode Setup.

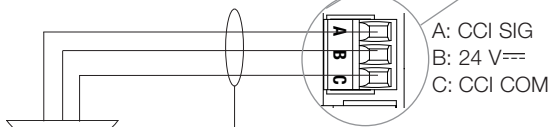

Example:
Occupancy sensor (maximum 1)

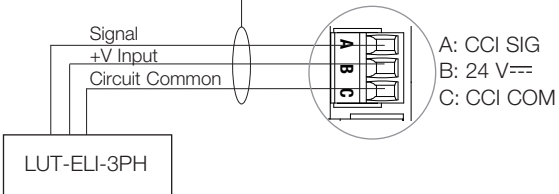

Example:
Emergency lighting interface (maximum 1)

Note: The GRAFIK Eye® QS control unit must be powered by a Normal/Emergency distribution panel for proper ELI operation. Refer to the LUT-ELI-3PH Installation Guide for the complete wiring diagram.

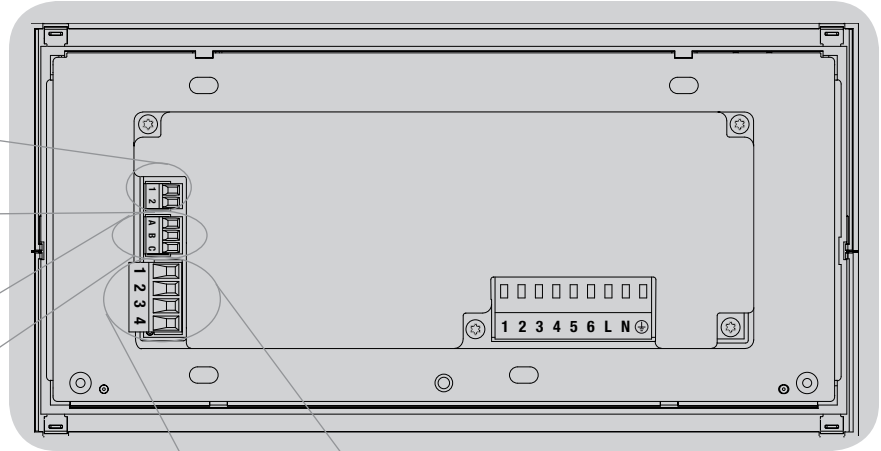

QS Link Control Wiring

24 V⁼⁼ 100 mA
Common and power (terminals 1 and 2):
Two 1.0 mm² each terminal (for link <153 m)
Two 4.0 mm² each terminal (for link 153-610 m)

To control stations, window treatments, or other GRAFIK Eye® QS control units

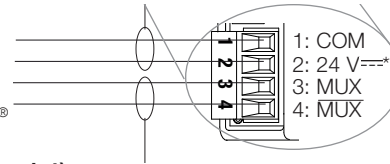

Data (terminals 3 and 4):
Twisted, shielded pair 0.5 mm² each terminal

*Do not connect terminal 2 between any GRAFIK Eye® QS control unit and any other power supply, including another GRAFIK Eye® QS control unit. See "Power Group Wiring" for a detailed wiring example.

Note: Use appropriate wire connecting devices as specified by local codes.

Wiring the GRAFIK Eye® QS Control Unit: QS Link Control Wiring Details

- System communication uses IEC PELV/NEC® Class 2 wiring.
- Follow all local and national electrical codes when installing IEC PELV/NEC® Class 2 wiring with line voltage/mains wiring.
- Each terminal accepts up to two 1.0 mm² wires.
- Total length of control link must not exceed 610 m.
- Make all connections in the control unit's wallbox.
- Wiring can be T-tapped or daisy-chained.
- IEC PELV/NEC® Class 2 24 V_{DC} 150 mA.

System Limits

The QS wired communication link is limited to 100 devices or 100 zones.

The GRAFIK Eye® QS control unit supplies 3 Power Draw Units (PDUs) on the QS link. Refer to the QS Link Power Draw Units specification submittal (Lutron PN 369405) for more information concerning Power Draw Units.

T-Tap Wiring Example

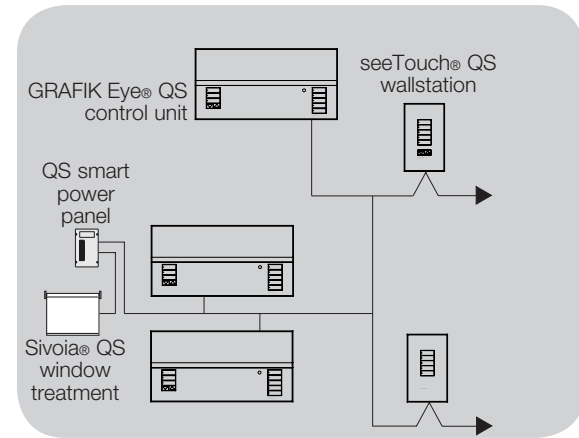

Daisy-Chain Wiring Example

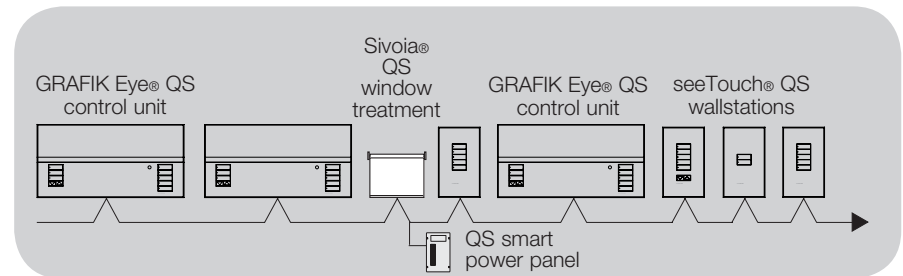

Wire Sizes (check compatibility in your area)

QS Link Wiring Length	Wire Gauge	Lutron Cable Part Number
Less than 153 m	Power (terminals 1 and 2) 1 pair 1.0 mm ²	GRX-CBL-346S GRX-PCBL-346S
	Data (terminals 3 and 4) 1 twisted, shielded pair 0.5 mm ²	
153 to 610 m	Power (terminals 1 and 2) 1 pair 4.0 mm ²	GRX-CBL-46L GRX-PCBL-46L
	Data (terminals 3 and 4) 1 twisted, shielded pair 0.5 mm ²	

Wiring the GRAFIK Eye® QS Control Unit: Power Group Wiring Example

On the QS link, there are devices that supply power and devices that consume power. Each device has a specific number of Power Draw Units (PDUs) it either supplies or consumes. A Power Group consists of one device that supplies power and one or more devices that consume power; each Power Group may have only one power-supplying device. Refer to the QS Link Power Draw Units specification submittal (Lutron PN 369405) for more information concerning PDUs.

Within Power Groups on the QS link, connect all 4 terminals (1, 2, 3, and 4), shown by the letter A in the diagram. Between devices on the QS link that supply power, connect only terminals 1, 3, and 4 (NOT terminal 2), shown by the letter B on the diagram.

Wiring can be T-tapped or daisy-chained.

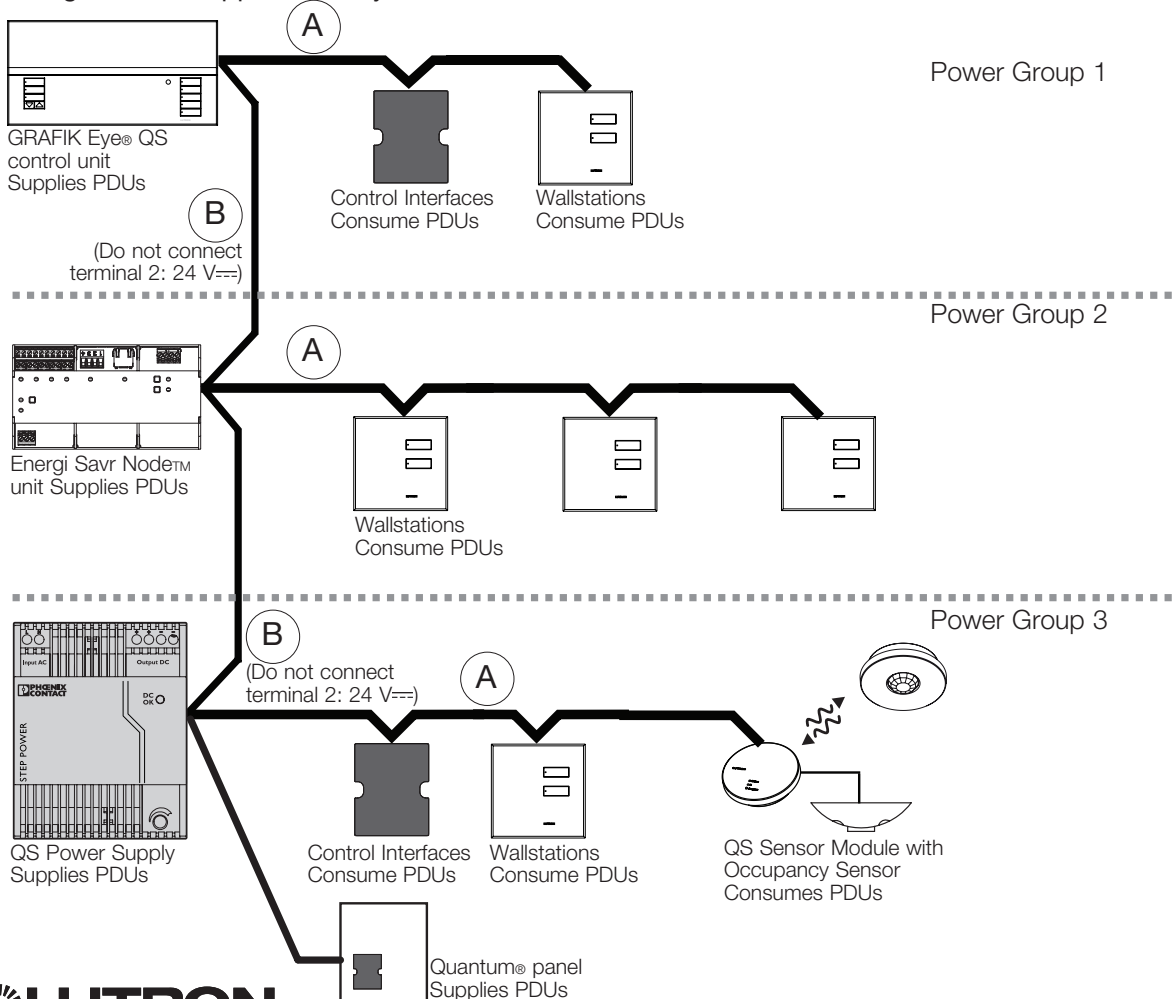

A

Connect all 4 terminals **within** a power group:

- 1: Common
- 2: 24 V~
- 3 and 4: Data

B

Connect only 3 terminals **between** power groups:

- 1: Common
- 3 and 4: Data

Do not connect Terminal 2: 24 V~

Wiring the GRAFIK Eye® QS Control Unit: Powering More Than 3 Wallstations Example

The GRAFIK Eye® QS control unit can power up to 3 seeTouch® wallstations. An external 24 V $\overline{=}$ power supply is required to power more than three wallstations.

- The +24 VDC wire from the power supply connects to QS link terminal 2 on all of the wallstations it is powering. This wire does not connect to terminal 2 on the GRAFIK Eye® QS control unit.
- The Common wire from the power supply connects to QS link terminal 1 on all of the wallstations it is powering and terminal 1 on the GRAFIK Eye® QS control unit.
- The communication signals on the QS link (terminals 3 and 4) connect from the wallstations to the GRAFIK Eye® QS control unit on twisted, shielded cable just as when an additional power supply is not being used. Control unit shown in rear view.

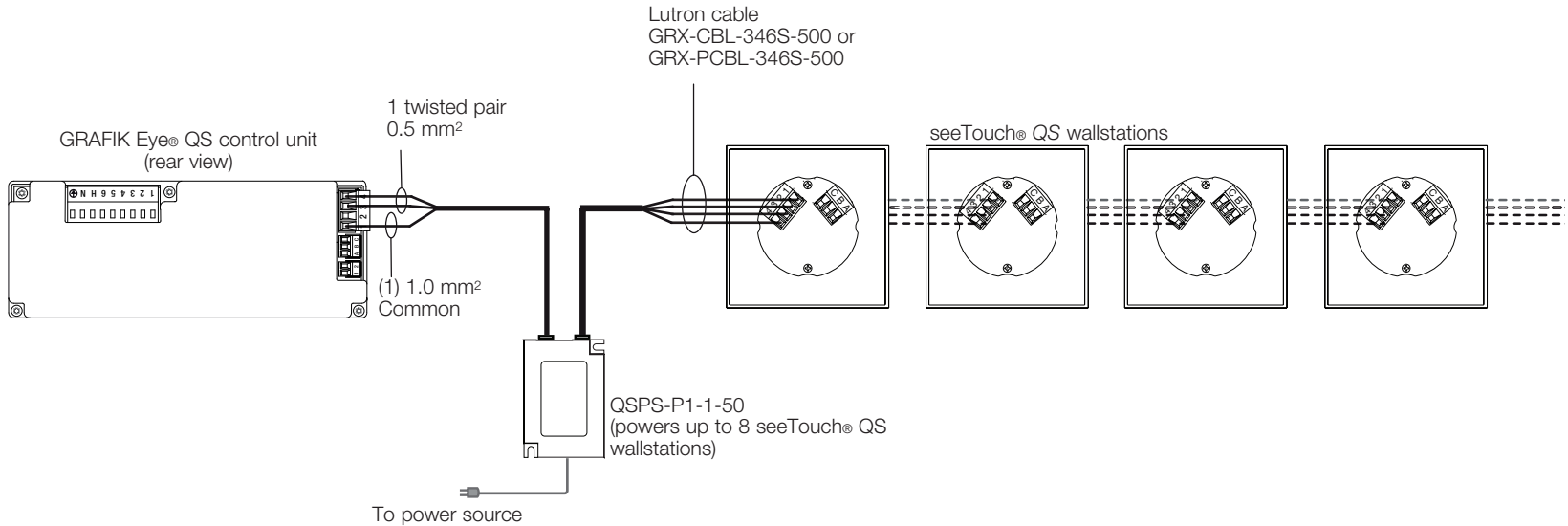

Completing Installation of the GRAFIK Eye® QS Control Unit

1. Mount the control unit in the wallbox as shown using the four screws provided.

Note: Follow all local and national electrical codes when installing IEC PELV/NEC® Class 2 wiring with line voltage/mains wiring.

2. Verify installation:

- Restore power.
- Press the top scene button. The LED will light.
- Press the zone raise and lower buttons. Make sure the control unit is dimming all connected loads.

3. Apply the protective overlay to the control unit.

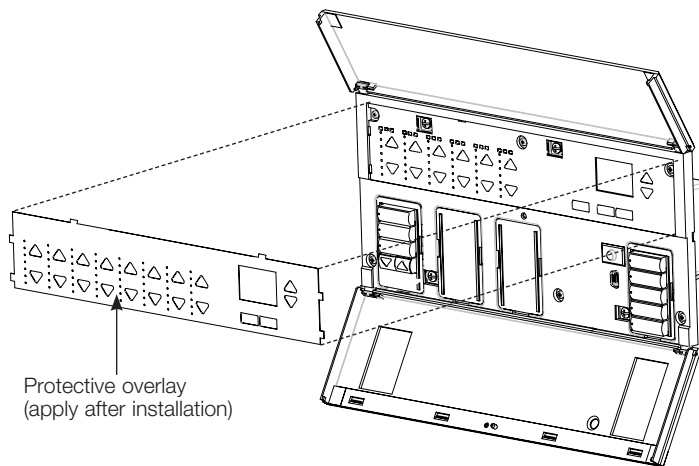
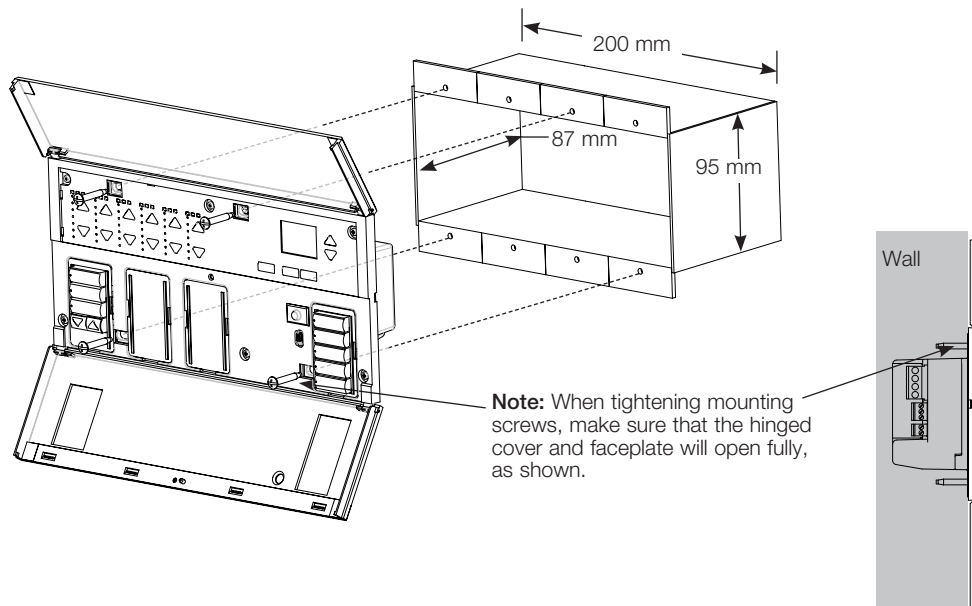

General Functionality

The info screen turns off 30 seconds after the last button press or completion of the last scene change. See example screens below.



The **Master** buttons activate the info screen. These buttons temporarily raise or lower all dimmable lights (except those programmed as unaffected in the current scene). Adjustments are temporary and do not affect scene programming.

Note: Master buttons affect all zones.

 The **OK** button activates the info screen (when off), which then shows the current scene and its fade time. In Save Always mode, it allows fade time adjustment. In Save by OK mode, pressing a second time allows zone adjustment; pressing a third time allows fade adjustment.

 The **timeclock** button activates the info screen and displays the current time and the next event scheduled to occur. Pressing a second time displays the time, date, and afterhours status. Pressing a third time displays location and sunrise/sunset times. Pressing a fourth time displays the language selection screen. Pressing once more returns to the first screen.

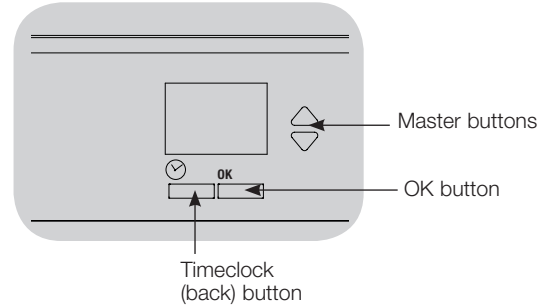
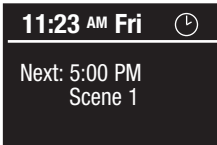
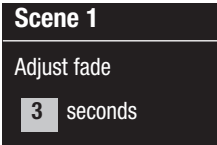
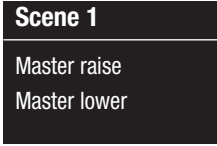

Pre-Programmed Button Functionality

The GRAFIK Eye® QS control unit controls most lighting loads without special programming. Each unit ships with pre-programmed default settings for the scene and shade buttons. For load types other than those shown below (dimmable or non-dim), assign the load type before proceeding. See the scene setup section for instructions on changing scene settings.

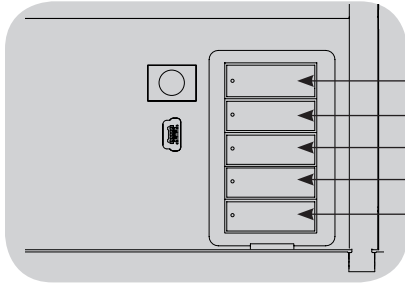

Scene Button Pre-Programming for Dimmable Loads

- Scene 1: All zones to 100%
- Scene 2: All zones to 75%
- Scene 3: All zones to 50%
- Scene 4: All zones to 25%
- All zones Off

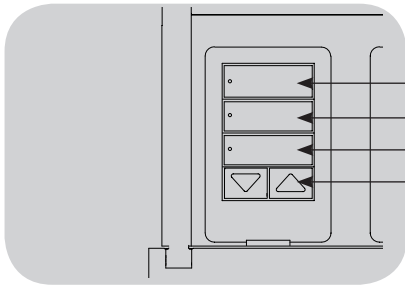

Shade Button Pre-Programming for Sivoia® QS window treatments

- All window treatments fully open
- All window treatments to 50%
- All window treatments fully closed
- Lower/Raise all window treatments
(Applies only to units with shade keypads)

Zone Button Operation

Each zone column (LEDs and buttons) represents one zone of lights. Pressing any button on a column turns on the info screen and displays the zone's current light level and current energy savings.

Pressing the raise and lower buttons on a zone causes different actions depending on zone type (see below).

Dimmable zones:

- Press and hold to raise/lower all lights in a zone; release to stop
- Press raise or lower to stop a zone that is fading
- Raising lights from off to full on or lowering from full on to off takes 5 seconds
- Press raise and lower simultaneously to toggle between full on and off
- Press and hold lower for 6 seconds after the zone has gone to 0% light level to set the zone as unaffected in the current scene. The zone will not change when this scene is initiated, and the Master buttons will not raise/lower the zone in this scene.

Non-dim zones:

- Press raise to turn zone on
- Press lower to turn zone off

Note: To set zone types, see the zone setup section.

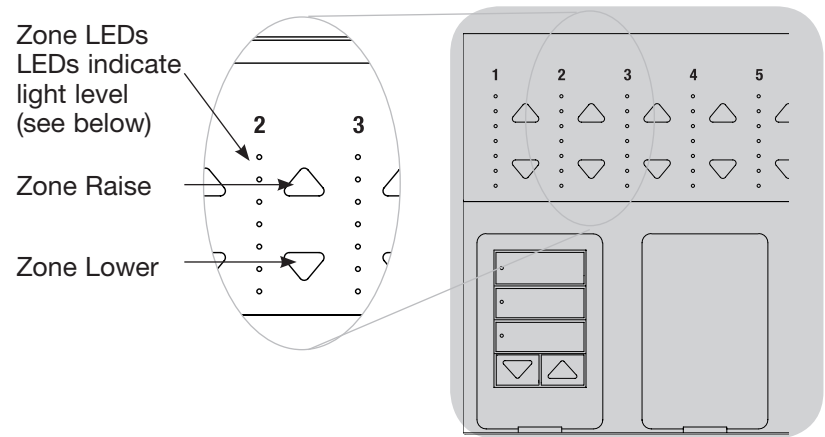

Zone LED Displays for % of Lighting Levels

Light Level (%)	Off	1-17	18-33	34-49	50-66	67-82	83-99	On/100	UA
Dimmable Load Types									
Non-Dim Load Types									

Legend:

UA = Unaffected (lights are not affected by scene button or Master buttons)



Programming Mode

Entering and Exiting Programming Mode

Main menu

Timeclock

Scene setup

Scene 1

Fade time
3 seconds

Entering programming mode:

Press and hold the top and bottom scene buttons simultaneously for 3 seconds. The LEDs in the scene buttons will scroll from top to bottom, confirming that you are in programming mode, and the info screen will display the main menu.

Exiting programming mode:

Press and hold the top and bottom scene buttons simultaneously for 3 seconds. The info screen will go to Scene 1.

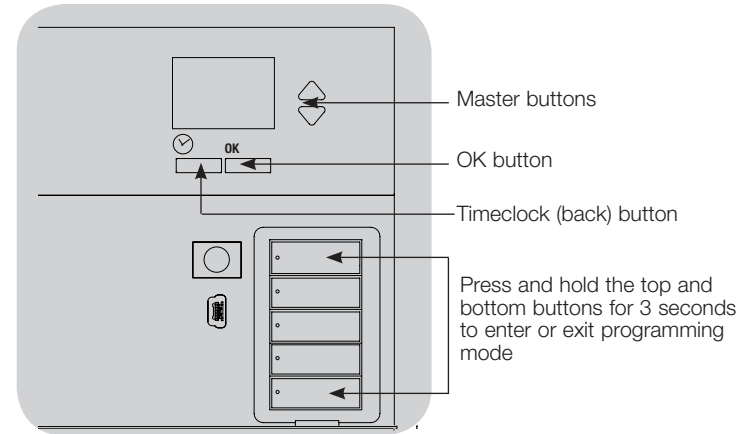

Navigating Menus in Programming Mode

Master Buttons

The Master buttons allow you to move through the menu choices. The current choice is highlighted on the info screen.

OK Button

The OK button chooses the current highlighted menu choice. This will either take you to the next menu or accept a setting you have selected. When the screen displays a Yes/No question, the OK button is “Yes”.

Timeclock Button

The timeclock button functions as a “back” button during programming mode. Pressing the timeclock button takes you back one step in the current menu. Pressing it repeatedly will eventually return you to the main menu, but will not exit programming mode. When the screen displays a Yes/No question, the Timeclock button is “No”.

Wireless Mode

Many models of the GRAFIK Eye® QS control unit support wireless communication with other Lutron® products. This feature allows for easy integration of wireless sensors, keypads, remotes, and window treatments for single-room wireless applications.

Units supporting wireless communication are labeled “GRAFIK Eye® QS Wireless” on the front label of the unit.

The wireless feature of the GRAFIK Eye® QS Wireless control unit has three (3) modes of operation.

- **Disabled:** Use for wired-only systems.
- **Enabled:** The GRAFIK Eye® QS Wireless control unit will respond to any programming commands from nearby Lutron QS wireless (and compatible) products.
- **Ignore Programming (default):** The GRAFIK Eye® QS Wireless control unit will only respond to normal operation commands from wireless devices associated while in Enabled mode.

Changing the wireless mode of the GRAFIK Eye® QS Wireless control unit:

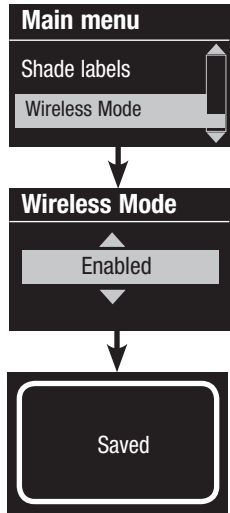

1. Enter programming mode.
2. Use the Master buttons to highlight “Wireless Mode” and press the OK button to accept.
3. Use the Master buttons to highlight the desired wireless mode, and press the OK button to accept.
4. The info screen will display a confirming “Saved” message.
5. Exit programming mode.

Note: The wireless signal has a range of 9 m through standard construction or 18 m line of sight.

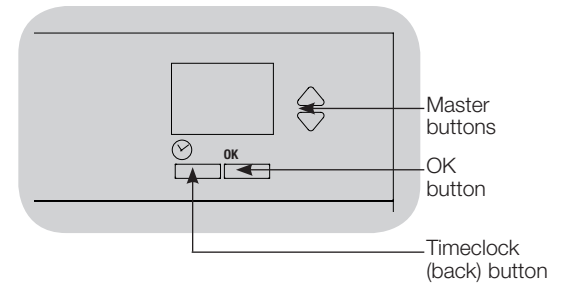

Zone Setup

Assigning Load Types

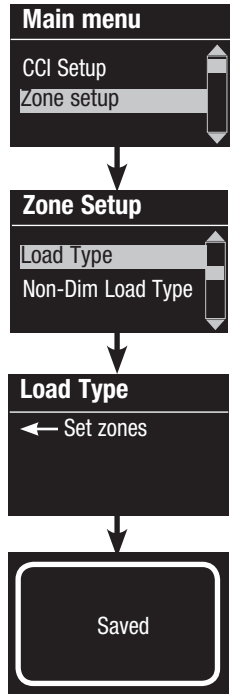

1. Enter programming mode.
2. Use the Master buttons to highlight “Zone setup” and press the OK button to accept.
3. Use the Master buttons to highlight “Load type”. Press the OK button to accept. See “Setting Load Types” table on the next page.
4. Use the zone raise/lower buttons to choose the load type for that zone. See the list on the next page for supported load types. Press the OK button to accept.
5. The info screen will confirm that your load type has been saved.
6. Exit programming mode.

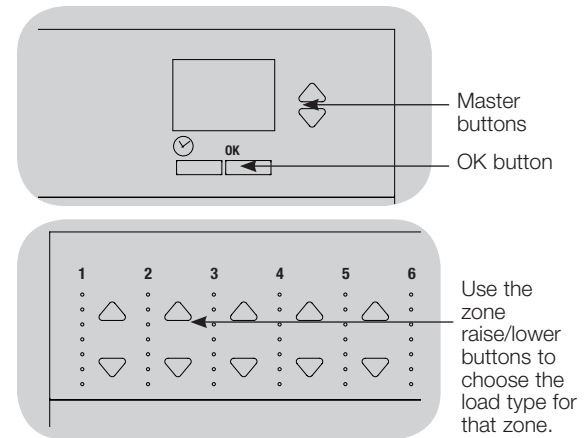

Assigning Non-Dim Load Type

Zones assigned to non-dim loads have three available configurations:

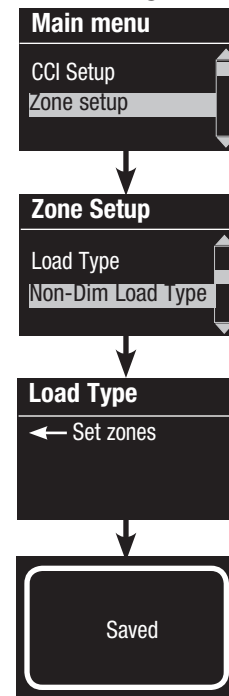

- LOFO: Last On, First Off
 - FOFO: First On, First Off
 - FOLO: First On, Last Off
- Scenes made up of both dim and non-dim load types will toggle the non-dim loads before the dim loads in a “First” on/off configuration, and after the dim loads in a “Last” on/off configuration.
1. Enter programming mode.
 2. Use the Master buttons to highlight “Zone setup” and press the OK button to accept.
 3. Use the Master buttons to highlight “Non-Dim Load type”. Press the OK button to accept. See “Setting Load Types” table on the next page.
 4. Use the zone raise/lower buttons to choose the non-dim load type for that zone. (Zones not programmed as non-dim will be displayed as Unaffected.) Press the OK button to accept.
 5. The info screen will confirm that your load type has been saved.
 6. Exit programming mode.

Zone Setup (continued)

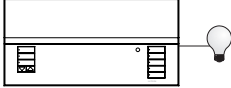
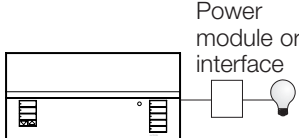
Setting Load Types			
		Direct control via GRAFIK Eye® QS control unit 	Control via power module or interface 
	Fixture load type	Choose this load type from the menu on the GRAFIK Eye® QS control unit:	
Zones 1 - 6	Incandescent	Incandescent	Power module
	MLV (magnetic low-voltage)	MLV	Power module
	ELV (electronic low-voltage)	—	Power module
	Hi-lume®/Eco-10®	—	Fluorescent module
	0-10 V	—	Fluorescent module
	Non-dim lighting loads	Non-dim	Non-dim
	Neon/Cold cathode	Neon, CC	Neon, CC
	DMX	—	DMX
RGB/CMY DMX	—	RGB/CMY DMX	

Load Type Notes

- All electronic low-voltage (ELV) lighting used with an interface must be rated for reverse phase control dimming. Before installing an ELV light source, verify with the manufacturer that their transformer can be dimmed. When dimming, an ELV interface (such as the PHPM-PA-DV-WH) must be used with the control unit.
- For all DMX or RGB/CMY DMX lighting, an external DMX interface (such as the QSE-CI-DMX) must be used with the control unit.

Zone ratings:

- Not all zones must be connected; however, connected zones must have a minimum load of 40 W.
- Maximum loads:
10 A per unit
500 W per zone.
- Maximum total lighting load for a magnetic low-voltage (MLV) load is 500 VA / 400 W.

Zone Setup

Setting High End or Low End Trim

- If you are unsure about appropriate high and low end settings, please contact Lutron Technical Support for assistance.
- High and low end trim settings limit the maximum and minimum output of a dimming zone. Trim levels are set automatically when the load type is programmed.

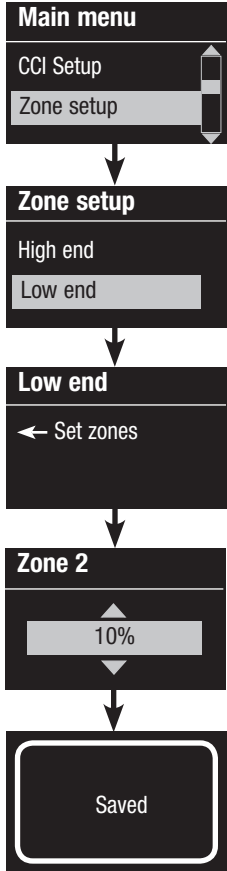

1. Enter programming mode.
2. Use the Master buttons to highlight “Zone setup” and press the OK button to accept.
3. Use the Master buttons to highlight “High end” or “Low end” (this example shows low end). Press the OK button to accept.
4. Use the zone raise/lower buttons to set the high end or low end trim for that zone. The info screen will display each zone number and percentage as you adjust it. Press the OK button to accept.
5. The info screen will confirm that your setting has been saved.
6. Exit programming mode.

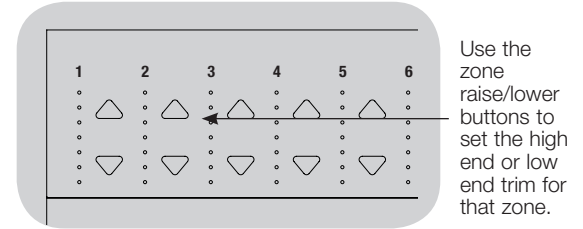
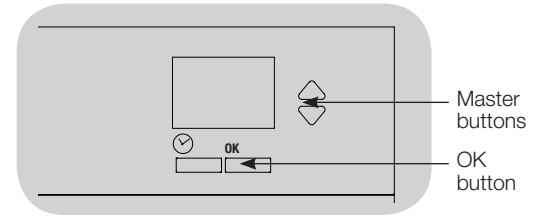

Setting Minimum Level (optional)

Some local regulations specify a minimum lighting level for dimming zones in occupied buildings. If this pertains to you, follow these steps to set up your minimum lighting level.

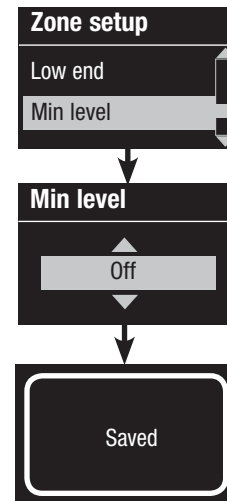

1. Enter programming mode and select “Zone setup,” then “Min level”. Press the OK button to accept.
2. Use the Master buttons to highlight “OFF” if you want your lights to go all the way off at their minimum light level, or “10%” if you want that to be the minimum light level. Press the OK button to accept.
Note: Non-dim loads will turn off regardless of the minimum level setting.
3. The info screen will confirm that your minimum level has been saved.
4. Exit programming mode.

Zone Setup

Labeling a Zone (optional)

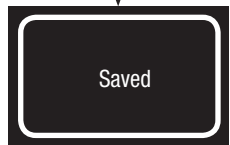
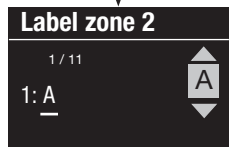
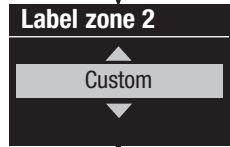
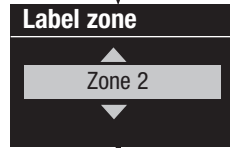
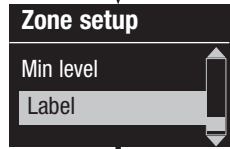
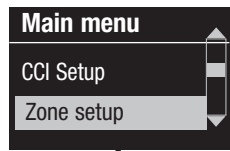

1. Enter programming mode.
2. Use the Master buttons to highlight “Zone setup” and press the OK button to accept.
3. Use the Master buttons to highlight “Label” and press the OK button to accept.
4. Use the Master buttons to change the zone number to your desired zone. Custom zone labels will appear if previously set. Press the OK button to accept.
5. Use the Master buttons to highlight “Custom” and press the OK button to accept. Or, highlight “Default” to return the zone label to the default (e.g., Zone 1).
6. Use the Master buttons to scroll through the characters (lowercase and uppercase letters, plus numbers 0 through 9). The character you are currently changing will be underlined on the screen. Press OK to select the character you want, then repeat for all available characters. Choose a space (no character) and press OK for any remaining characters. Press the OK button to accept.
7. The info screen will confirm that your name has been saved.
8. Exit programming mode.

Note: Custom zone labels will always begin with the zone number and a colon (e.g., 1: Uplights).

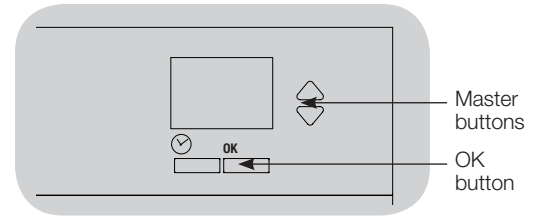

Scene Setup

Setting Zone Levels, Fade Rates, and Window Treatment (Shade) Group Actions

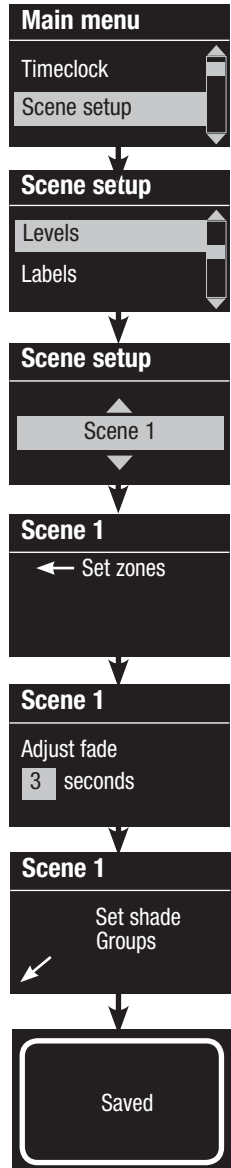

1. Enter programming mode.
2. Use the Master buttons to highlight “Scene setup” and press the OK button to accept.
3. Use the Master buttons to highlight “Levels” to adjust lighting and/or window treatment levels. Press the OK button to accept. Use the Master buttons to highlight the scene number of your desired scene. Press the OK button to accept.
4. Set each zone to the desired light level for this scene using the zone raise/lower buttons. The info screen will display the zone and percentage as you adjust it.
To set a zone as unaffected, lower the light levels all the way to off, then hold the zone lower button for 3 seconds. The screen will display “---” and the three middle LEDs for the zone will be lit to indicate this zone is unaffected by the scene (the zone will not change when this scene is initiated).
When all zones are at the desired level, press the OK button to accept.
5. Use the Master buttons to set the fade time for this scene. Press the OK button to accept.
6. **Note:** This step is applicable only if you have window treatments on your system. If you do not have or do not wish to set window treatment groups for this scene, press the OK button to skip this step.
Set each window treatment group to the desired level for this scene. When all window treatment groups are at the desired level, press the OK button to accept.
For window treatment programming, see the section on adjusting shade settings.
7. The info screen will confirm that your scene has been saved.
8. Exit programming mode.

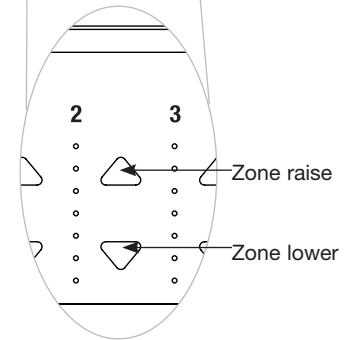
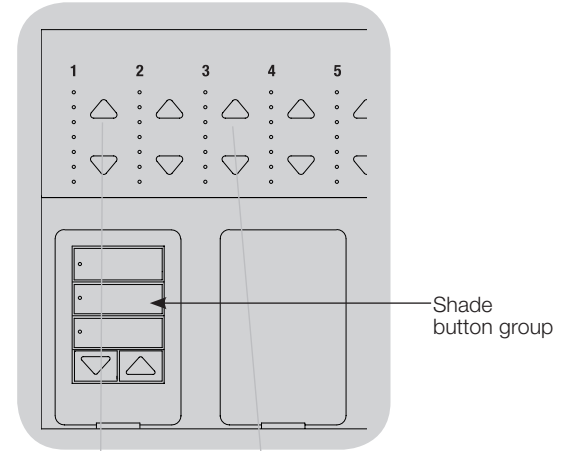
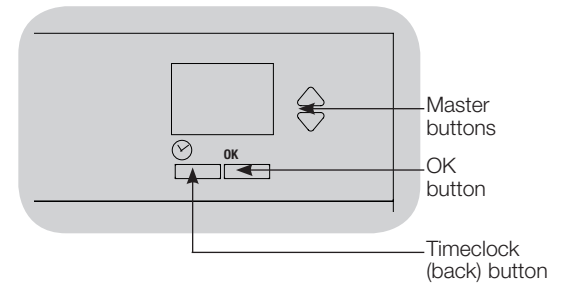

Scene Setup

Labeling a Scene (optional)

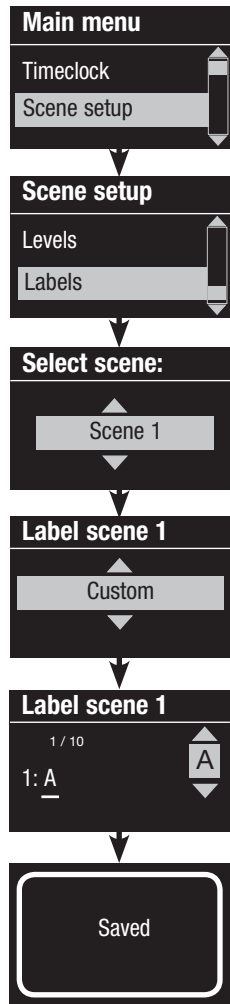

1. Enter programming mode.
2. Use the Master buttons to highlight “Scene setup” and press the OK button to accept.
3. Use the Master buttons to highlight “Labels” and press the OK button to accept.
4. Use the Master buttons to highlight your desired scene. Press the OK button to accept.
5. Use the Master buttons to highlight “Custom” and press the OK button to accept.
6. Use the Master buttons to scroll through the characters (lowercase and uppercase letters, plus numbers 0 through 9). The character you are currently changing will be underlined on the screen. Press OK to select the character you want, then repeat for all available characters. Choose a space (no character) and press OK for any remaining characters. Press the OK button to accept.
7. The info screen will confirm that your name has been saved.
8. Exit programming mode.

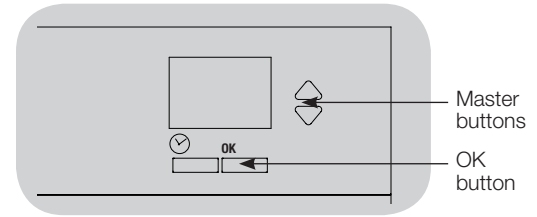

Enabling/Disabling Daylighting in a Scene

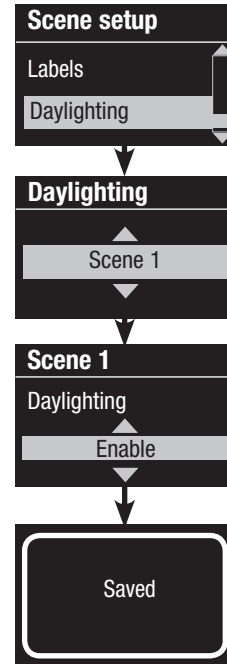

1. Enter programming mode.
2. Use the Master buttons to highlight “Scene setup” and press the OK button to accept.
3. Use the Master buttons to highlight “Daylighting” and press the OK button to accept.
4. Use the Master buttons to highlight your desired scene. Press the OK button to accept.
5. Use the Master buttons to select “Enable” or “Disable”. When daylighting is disabled in a scene, the GRAFIK Eye® QS control unit will not respond to daylight sensors information when that scene is active. Press OK to save.
6. Exit programming mode.

Setting Save Mode

The Save Mode of the GRAFIK Eye® QS control unit can be adjusted to turn quick scene programming on and off, or to disable the use of zone and/or scene buttons for specific applications.

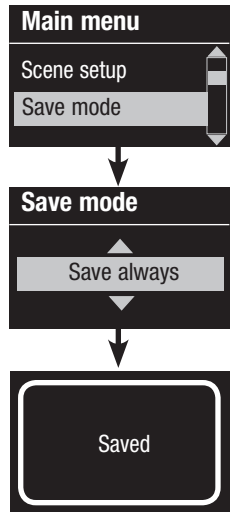

Save Mode Settings

Save by OK (default): Quick scene programming mode; zone adjustments are temporary until the OK button is pressed to confirm the selection.

Save always: Automatically save changes made to lighting levels or fade time to Off (Master button changes are temporary).

Save never: Do not save any temporary changes to lighting levels or fade time.

Four scenes (typically used for rented spaces): Zone raise/lower buttons are disabled. Master raise/lower buttons, wallstations, and IR receiver are still enabled for adjustment of light level, but these changes are not saved.

Button disable (typically used in a public space): Only the timeclock button, IR receiver, and wallstations can be used to make temporary changes.

Changing the Save Mode

1. Enter programming mode.
2. Use the Master buttons to highlight “Save mode” and press the OK button to accept.
3. Use the Master buttons to highlight the desired save mode. The save modes are listed and explained below.
4. Press the OK button to accept. The info screen will confirm that your save mode has been saved.
5. Exit programming mode.

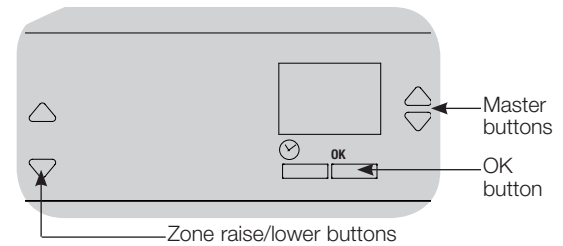

Quick Scene Programming: Save by OK Mode

By default, the GRAFIK Eye® QS control unit is in “Save by OK” mode, which allows you to quickly set scenes without entering program mode.

1. Press the button for the scene you want to set; its LED will light and the lights will go to the current settings.
2. Use the zone raise/lower buttons to set all lights to the desired levels. Press the OK button to select.
3. Set the fade time to the desired length using the Master buttons, and press the OK button to save.
4. The info screen will confirm that the new scene settings have been saved.

Notes

- Using the Master buttons to raise or lower lighting settings is still temporary.
- To set a zone to unaffected (---), press and hold the zone lower button for 6 seconds after the zone has gone to 0% light level.

Contact Closure Input (CCI) Setup

(wired directly to the GRAFIK Eye® QS control unit)

The integral contact closure input (CCI) on the back of the GRAFIK Eye® QS control unit can be configured as:

Occupancy (default): Allows a wired occupancy sensor to be included in the list of available sensors when setting up occupancy actions.

Emergency: This setting allows the GRAFIK Eye® QS control unit to work with a LUT-ELI-3PH emergency lighting interface. When an emergency situation is detected, all lights will go to full on, and will not change until the emergency signal is cleared.

Afterhours: Allows the CCI to start and end Afterhours.

Timeclock: Allows the CCI to enable and disable the timeclock.

Lockout: Prevents the user from making any changes to the control unit. The current scene will stay on until the CCI enables normal operation.

Never Save: Prevents any changes from being saved while the CCI is being used.

Disable CCI: The CCI will have no effect on the system and will not appear on the list of available occupancy sensors within the sensor setup menu.

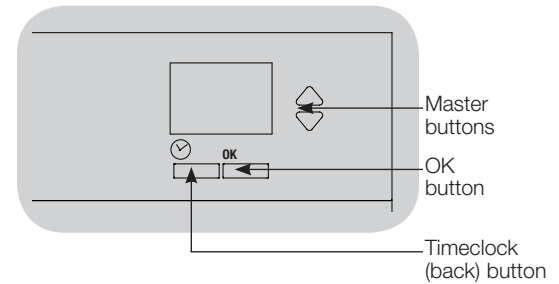

Changing the operation of the contact closure input:

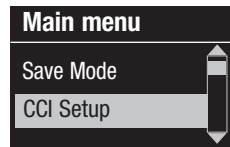

1. Enter programming mode.
2. Use the Master buttons to highlight "CCI Setup" and press the OK button to accept.
3. Use the Master buttons to highlight "CCI Mode" and press the OK button to accept.
4. Use the Master buttons to highlight the mode you wish the CCI to control. Press the OK button to accept.
5. The info screen will confirm that your setting has been saved.
6. Exit programming mode.

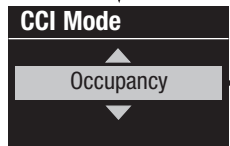
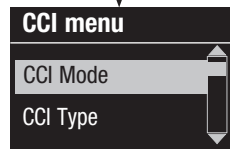

(continued on the next page)

Contact Closure Input (CCI) Setup (continued)

(wired directly to the GRAFIK Eye® QS control unit)

The integral contact closure input (CCI) on the back of the GRAFIK Eye® QS control unit is compatible with either type of contact closure device:

Maintained (default): The GRAFIK Eye® QS control unit will act on both a contact closure and a contact open/release event.

Example: CCI Mode set to Afterhours. Contact closure starts Afterhours. Contact open/release ends Afterhours.

Momentary: The GRAFIK Eye® QS control unit will act on only contact closure events.

Example: CCI Mode set to Afterhours. Contact closure starts Afterhours. Contact open/release has no effect. Second contact closure ends Afterhours.

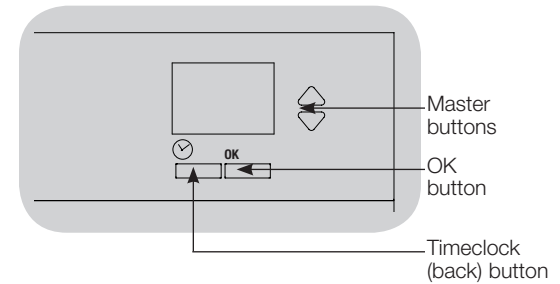

Changing the type of contact closure input:

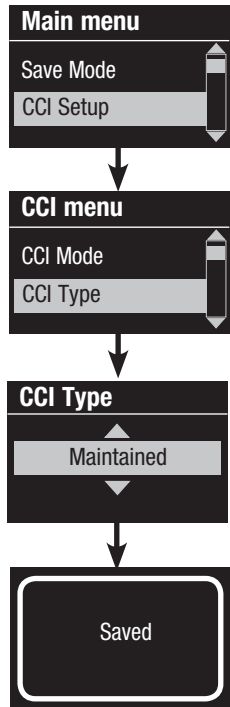

1. Enter programming mode.
2. Use the Master buttons to highlight “CCI Setup” and press the OK button to accept.
3. Use the Master buttons to highlight “CCI Type” and press the OK button to accept.
4. Use the Master buttons to highlight the type you wish the CCI to control. Press the OK button to accept.
5. The info screen will confirm that your setting has been saved.
6. Exit programming mode.

Note: The Emergency CCI Mode is different from the other CCI modes in that Emergency Mode will activate on a contact open/release and will deactivate on a contact closure. The CCI must be set to Maintained (default) for proper Emergency Mode operation.

Occupancy Sensor Setup

Lutron occupancy and vacancy sensors work with the GRAFIK Eye® QS Wireless control unit to automatically adjust light levels when occupancy or vacancy is detected.

Wired occupancy and vacancy sensors may be connected to the contact closure input on the GRAFIK Eye® QS control unit, a QS Sensor Module (QSM), or a Contact Closure Interface in the GRAFIK Eye® QS system.

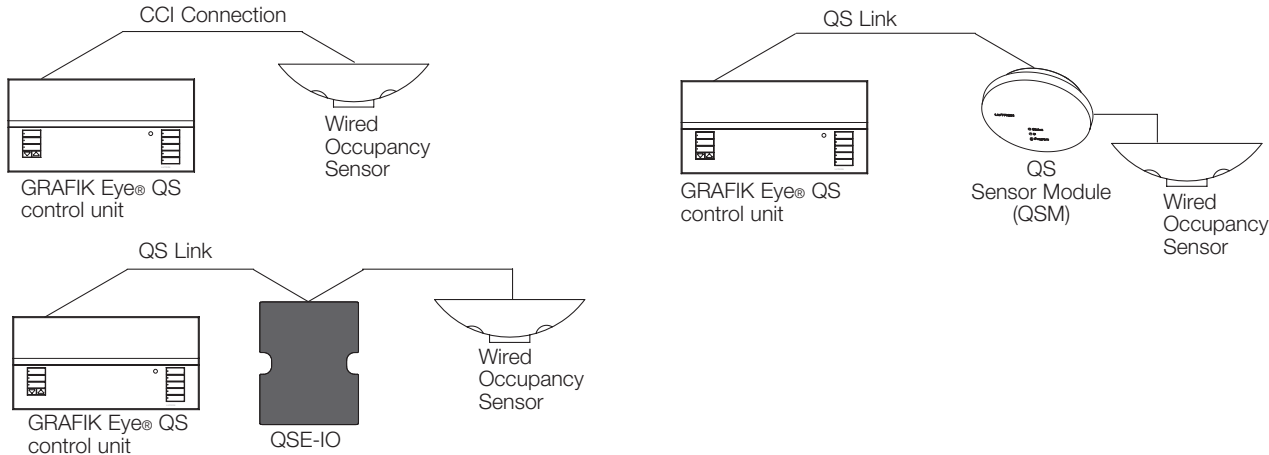

Wireless Radio Powr Savr™ occupancy and vacancy sensors can be associated with a GRAFIK Eye® QS Wireless or QSM. Wireless sensors must first be associated to one of these devices before they will be recognized by a GRAFIK Eye® QS Wireless system. (This section applies to installations where the GRAFIK Eye® QS Wireless is being used in a single-room wireless installation. Refer to the RadioRA® 2 installation guide for setting up wireless occupancy and vacancy sensors in a RadioRA® 2 system.)



The following steps are required to program occupancy sensors with a GRAFIK Eye® QS control unit.

1. Connect wired sensors, or associate wireless sensors.
2. Choose the mode of operation (scene control or zone control).
3. Select sensors.
4. Assign sensor actions.
5. Configure sensor settings (optional).

Occupancy Sensor Setup

Associating wireless occupancy sensors and GRAFIK Eye® QS Wireless control units (for wireless enabled units only):

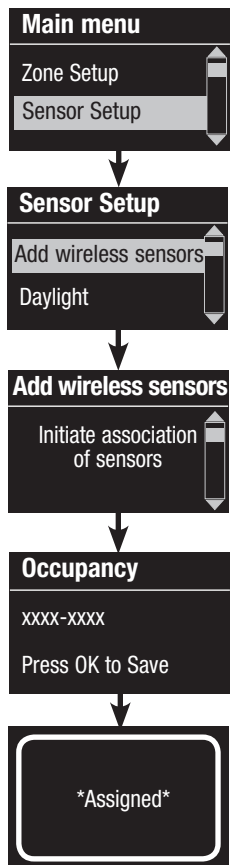

1. Make sure the wireless mode of the GRAFIK Eye® QS control unit is “Enabled”.
2. Enter programming mode.
3. Use the Master buttons to highlight “Sensor setup” and press the OK button to accept.
4. Use the Master buttons to highlight “Add wireless sensors” and press the OK button to accept.
5. Press and hold the “Lights Off” button (💡 on some sensors) on the occupancy sensor for 6 seconds. The lens will start flashing and the info screen on the GRAFIK Eye® QS Wireless control unit will display the sensor’s serial number.
6. Press the OK button on the GRAFIK Eye® QS control unit. A screen will confirm that the sensor has been assigned. (To disassociate a wireless occupancy sensor from the GRAFIK Eye® QS control unit, Refer to the Radio Powr Savr® occupancy sensor install guide to return the sensor to its “out-of-box” functionality. Doing so will remove its programming from the GRAFIK Eye® QS control unit.)
7. Repeat the above steps for all desired sensors.
8. Exit programming mode.

Associating wireless occupancy sensors through QS Sensor Modules (QSM):

1. Press and hold the Program button on the QSM for 3 seconds to enter programming mode. There will be 1 audible beep and the Status LED will begin flashing. The info screen on the GRAFIK Eye® QS control unit will display that the QSM is in programming mode.
2. Press and hold the “Lights Off” button (💡 on some sensors) on the occupancy sensor for 6 seconds. There will be 3 audible beeps from the QSM to verify association.
3. Press and hold the Program button on the QSM for 3 seconds to exit programming mode.

Note: The wireless signal has a range of 9 m through standard construction or 18 m line of sight.

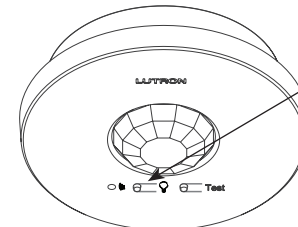
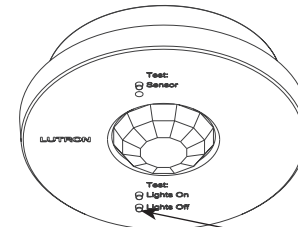
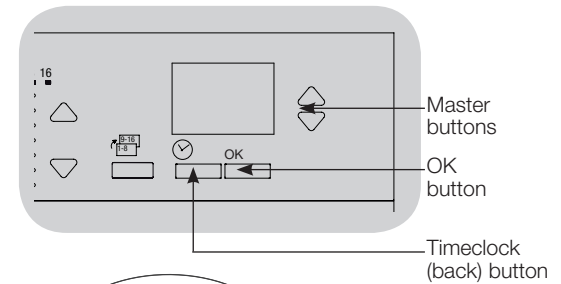

Radio Powr Savr™
Occupancy Sensors

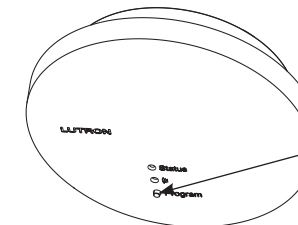

QS Sensor Module (QSM)

Occupancy Sensor Setup

When the GRAFIK Eye® QS system is first powered up, occupancy sensors connected to the contact closure input (and the first three associated wireless Radio Powr Savr™ occupancy sensors) will automatically operate in Scene Mode. Their defaults will be “No Action” for the occupied state and “Scene Off” for the unoccupied state. For additional sensors and/or alternate functionality, please complete all required programming actions.

Selecting the Mode

Scene Mode (default) is useful when the GRAFIK Eye® QS control unit is controlling lights in a single room or area. Up to four sensors can be assigned to the GRAFIK Eye® QS control unit to activate a scene when the space is occupied, and another scene when unoccupied.

Zone Mode is useful when the GRAFIK Eye® QS control unit is controlling lights in multiple areas within a room. Up to four sensors can be assigned to each zone (a sensor can be assigned to more than one zone) to send the zones to configurable occupied and unoccupied levels.

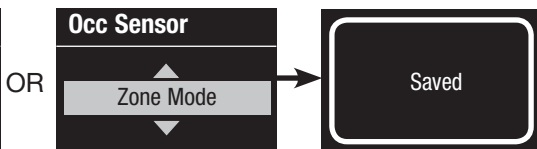
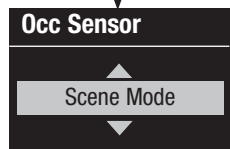
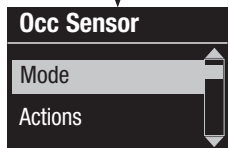
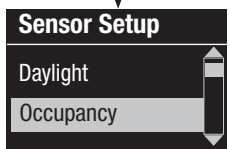
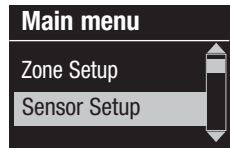
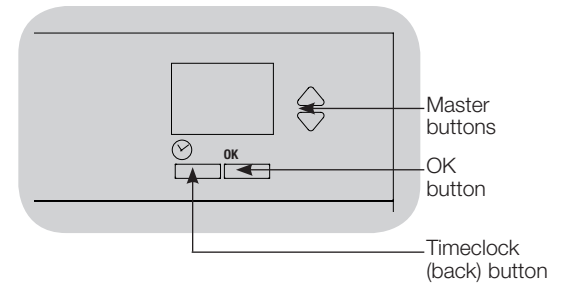

1. Enter programming mode.
2. Use the Master buttons to highlight “Sensor setup” and press the OK button to accept.
3. Use the Master buttons to highlight “Occupancy” and press the OK button to accept.
4. Use the Master buttons to highlight “Mode” and press the OK button to accept.
5. Use the Master buttons to highlight “Zone Mode” to assign sensors to zones, or “Scene Mode” (default). Press the OK button to accept. A screen will confirm your selected mode has been saved and you will return to the Daylight Sensor screen.

Note: Changing modes will remove all previous occupancy assignments.

Occupancy Sensor Setup

Scene Mode

This step allows you to assign up to four occupancy sensors to the GRAFIK Eye® QS control unit.

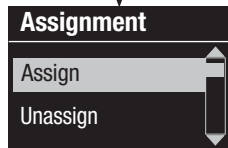
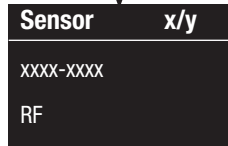
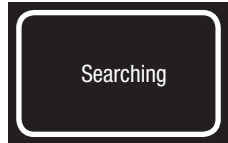
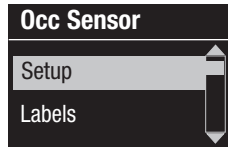

Selecting Sensors

1. If not already done, associate occupancy sensors and set to "Scene Mode".
2. Use the Master buttons to highlight "Setup" and press the OK button to accept. The info screen will display "Searching" while the unit detects available occupancy sensors.
3. Use the Master buttons to scroll through the list of available occupancy sensors. When the desired sensor is displayed, press the OK button to select it. Then choose "Assign" or "Unassign" from the following menu and press OK. Once a sensor has been assigned, it will appear with an asterisk (*) in the sensor list. Repeat for additional sensors.

Note: If wireless sensors are not found, verify that they are associated correctly.

Setting the Sensor Action

1. Press the Timeclock (back) button to return to the Occ Sensor screen. Use the Master buttons to highlight "Actions" and press the OK button. By default, the occupied scene is set to "No Action" and the unoccupied scene is set to "Scene Off".
2. Use the Master buttons to highlight the scene you wish to use for occupied status and press the OK button to accept. Repeat for the scene you wish to use for unoccupied status. Press the OK button to accept.
3. Exit programming mode.

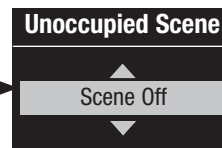
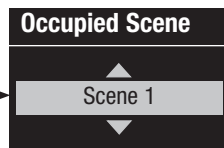
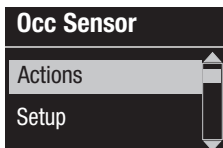
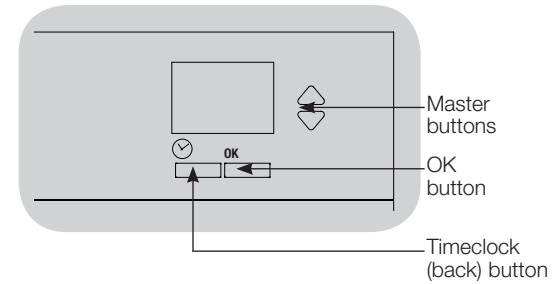

Occupancy Sensor Setup

Zone Mode

This step allows you to assign up to four occupancy sensors per zone to the GRAFIK Eye® QS control unit. Sensors can be added to more than one zone.

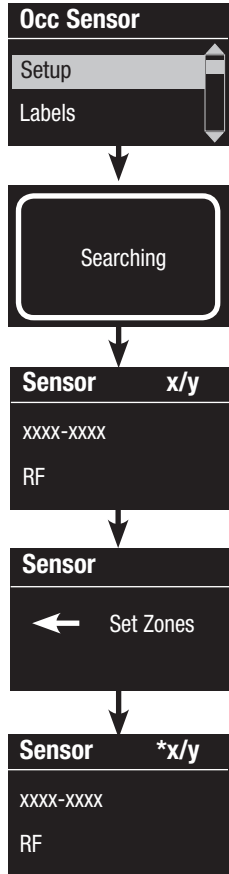

Selecting Sensors

1. If not already done, associate sensors and set to “Zone Mode”.
2. Use the Master buttons to highlight “Setup” and press the OK button to accept.
3. You can assign up to four sensors per zone, and a sensor can be assigned to more than one zone. Use the Master buttons to scroll through the sensors until the one you wish to assign or unassign is highlighted, and press the OK button to select it.
4. Use the zone raise and lower buttons for each desired zone to assign or unassign the sensor to that zone. The zone raise button assigns the displayed sensor, and the zone lower button unassigns it. Press the Timeclock (back) button to return to the list of available sensors. Once a sensor has been assigned, it will appear with an asterisk (*) in the sensor list. Repeat for additional sensors.

Note: If wireless sensors are not found, verify that they are associated correctly.

Setting the Sensor Action

1. Press the Timeclock (back) button to return to the Occ Sensor screen. Use the Master buttons to highlight “Actions” and press the OK button to accept.
2. Use the zone raise and lower buttons to adjust each zone to the desired occupied level and press the OK button to save. To set a zone as unaffected, lower the light levels all the way to off, then hold the zone lower button for 3 seconds. The screen will display “---” and the three middle LEDs for the zone will be lit to indicate this zone is unaffected by the scene (the zone will not change when this scene is initiated).
3. Use the zone raise and lower buttons to adjust each zone to the desired unoccupied level, and press the OK button to save.
4. Exit programming mode.

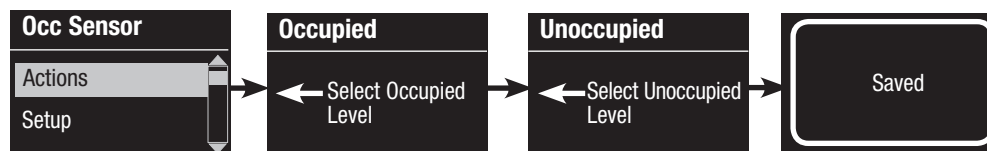
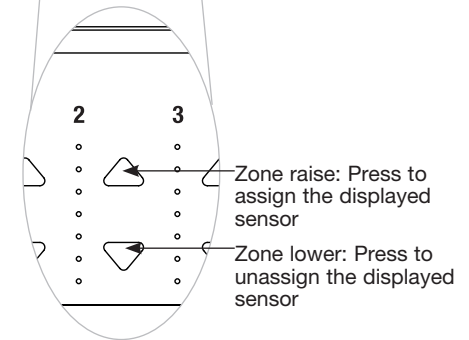
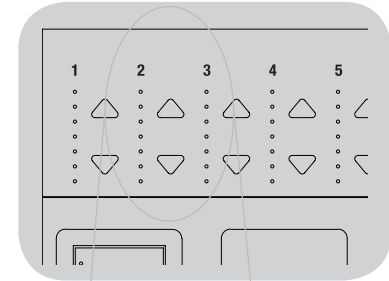
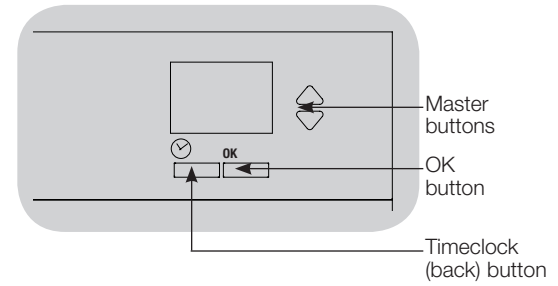

Occupancy Sensor Setup

Labeling an Occupancy Sensor (optional)

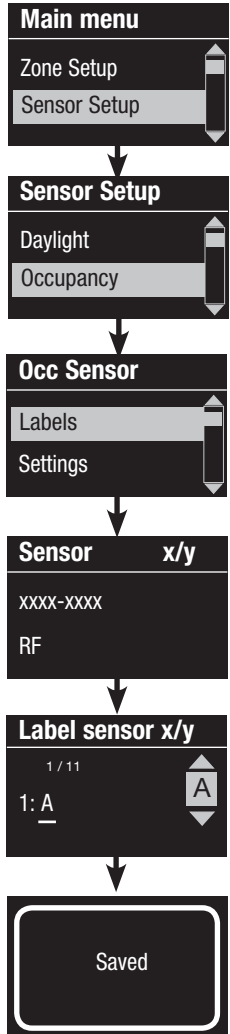

1. Enter programming mode.
2. Use the Master buttons to highlight “Sensor Setup” and press the OK button to accept.
3. Use the Master buttons to highlight “Occupancy” and press the OK button to accept.
4. Use the Master buttons to highlight “Labels” and press the OK button to accept.
5. Use the Master buttons to display an occupancy sensor to label and press OK to select.
6. Use the Master buttons to scroll through the characters (lowercase and uppercase letters, plus numbers 0 through 9). The character you are currently changing will be underlined on the screen. Press OK to select the character you want, then repeat for all available characters. Choose a space (no character) and press OK for any remaining characters. The info screen will confirm that your name has been saved. Repeat for all desired sensors.
7. Exit programming mode.

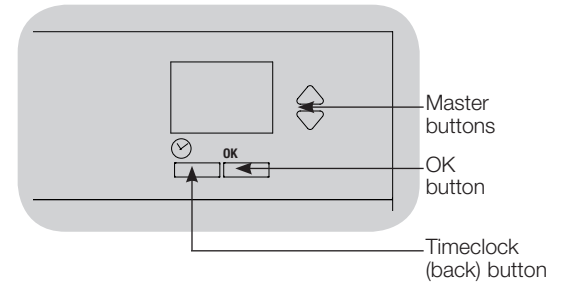

Occupancy Sensor Setup

Configuring Occupancy Sensor Settings (optional)

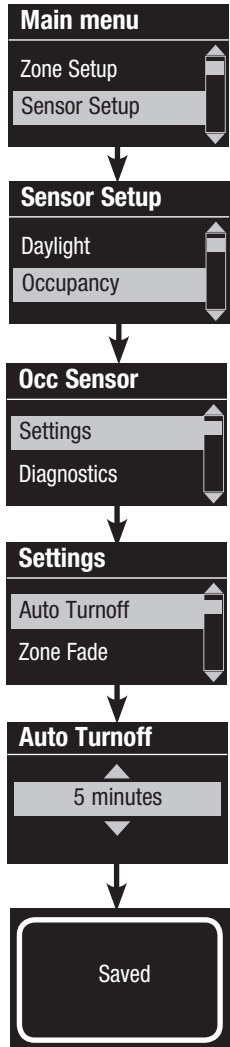

Occupancy Sensor Settings

Note: These settings affect all sensors assigned to the GRAFIK Eye® QS control unit.

Grace Period: If the GRAFIK Eye® QS control unit is transitioning to an unoccupied state, motion detected within the grace period will return the lights to the previously occupied level.

Range: 15 – 30 seconds (default 15 seconds).

Vacancy Delay: An additional time delay after vacancy is detected and before unoccupied action occurs. Use when occupancy sensor does not provide sufficient delay.

Range: 0 – 30 minutes (default 0 minutes).

Auto Turnoff: If lights assigned to an occupancy sensor are turned on manually without the sensor reporting occupancy, the GRAFIK Eye® QS control unit can be set to automatically turn off the lights after a set time delay. Disable this feature by setting the time delay to 0 (disabled).

Range: Disabled or 1 – 30 minutes (default Disabled).

Zone Fade: When in Zone Mode, lights can be set to fade to the unoccupied levels over this period of time.

Range: 0 – 59 seconds; 1 – 10 minutes (default 10 seconds).

Configuring the Sensor Settings:

1. Enter programming mode.
2. Use the Master buttons to highlight “Sensor Setup” and press the OK button to accept.
3. Use the Master buttons to highlight “Occupancy” and press the OK button to accept.
4. Use the Master buttons to highlight “Settings” and press the OK button to accept.
5. Use the Master buttons to highlight the setting you wish to configure. Press the OK button to accept.
6. Use the Master buttons to adjust the value of the selected setting. Press the OK button to accept.
7. The info screen will confirm that your setting has been saved.
8. Exit programming mode.

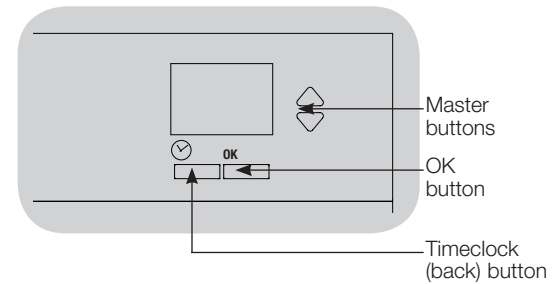

Daylight Sensor Setup

Lutron daylight sensors work with the GRAFIK Eye® QS Wireless control unit to automatically adjust electric light levels when natural light in the room changes.

Wired daylight sensors may be connected to a QS Sensor Module (QSM) in the QS system.

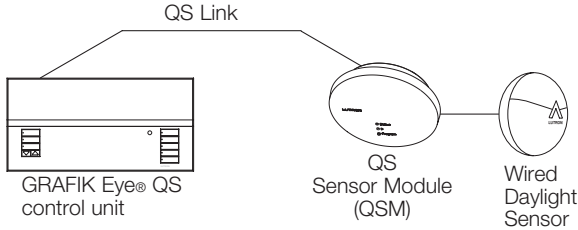

Wireless Radio Powr Savr™ daylight sensors can be associated with a GRAFIK Eye® QS control unit or QSM. Wireless sensors must first be associated with one of these devices to be recognized by a GRAFIK Eye® QS wireless system.

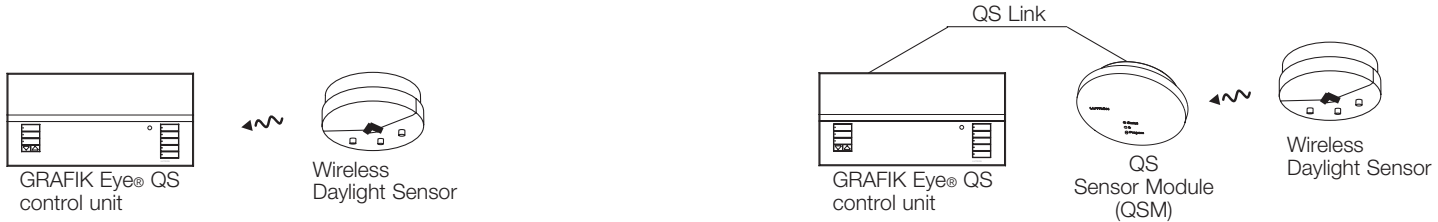

The following steps are required to program daylight sensors with a GRAFIK Eye® QS control unit. Instructions for each step are on the pages that follow.

1. Connect wired sensors, or associate wireless sensors.
2. Assign sensors to zones.
3. Calibrate the system to achieve the desired response to natural light.

Note: The Daylighting feature is not supported for the DMX load type.

Daylight Sensor Setup

Associating wireless daylight sensors and GRAFIK Eye® QS Wireless control units (for wireless enabled units only):

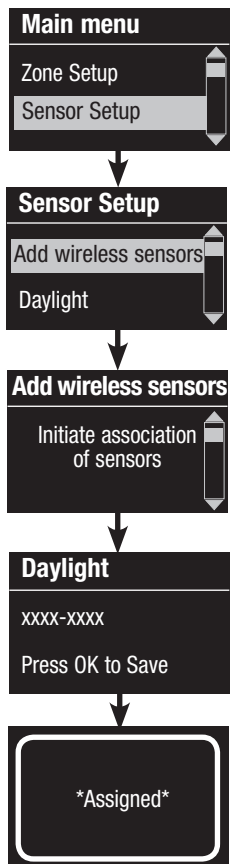

1. Make sure the wireless mode of the GRAFIK Eye® QS control unit is “Enabled”.
2. Enter programming mode.
3. Use the Master buttons to highlight “Sensor setup” and press the OK button to accept.
4. Use the Master buttons to highlight “Add wireless sensors” and press the OK button to accept.
5. Press and hold the “Link” button on the daylight sensor until the sensor starts flashing. The info screen on the GRAFIK Eye® QS control unit will display the sensor’s serial number.
6. Press the OK button on the GRAFIK Eye® QS control unit. A screen will confirm that the sensor has been assigned. (To disassociate a wireless daylight sensor from the GRAFIK Eye® QS control unit, Refer to the Radio Powr Savr™ daylight sensor install guide to return the sensor to its “out-of-box” functionality. Doing so will remove its programming from the GRAFIK Eye® QS control unit.)
7. Repeat the above steps for all desired sensors.
8. Exit programming mode.

Associating wireless daylight sensors through QS Sensor Modules (QSM):

1. Press and hold the Program button on the QSM for 3 seconds to enter programming mode. There will be 1 audible beep and the Status LED will begin flashing. The info screen on the GRAFIK Eye® QS control unit will display that the QSM is in programming mode.
2. Press and hold the “Link” button on the daylight sensor for 6 seconds. There will be 3 audible beeps from the QSM to verify association.
3. Press and hold the Program button on the QSM for 3 seconds to exit programming mode.

Note: The wireless signal has a range of 9 m through standard construction or 18 m line of sight.

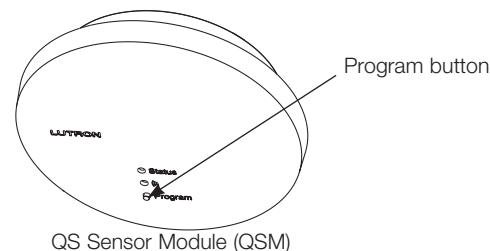
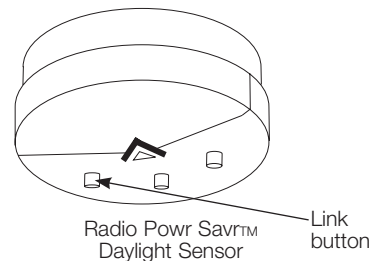
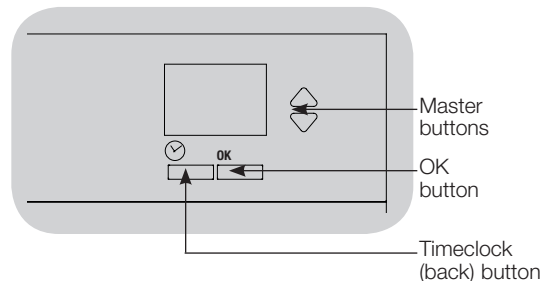

Daylight Sensor Setup

This step allows you to assign sensors to zones on the GRAFIK Eye® QS control unit. Each zone can be assigned to only one sensor, but sensors can be assigned to more than one zone.

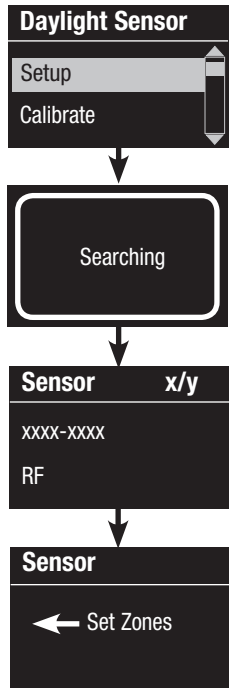

Selecting Sensors

1. If not already done, associate daylight sensors.
2. Use the Master buttons to highlight “Setup” and press the OK button to accept. Available sensors will be displayed.
3. Use the Master buttons to scroll through the sensors until the one you wish to assign or unassign is highlighted, and press the OK button to select it.
4. Use the zone raise and lower buttons for the desired zones to assign or unassign the sensor to those zones. The zone raise button assigns the displayed sensor, and the zone lower button unassigns it. Press the Timeclock (back) button to return to the list of available sensors. Repeat for additional sensors.

Calibrating the Sensors

1. Put any wireless Radio Powr Savr™ daylight sensors associated with the desired zones into Calibrate Mode: Press and hold the “Cal” button for 6 seconds until the sensor flashes.
Note: After 5 minutes, Calibrate Mode will timeout, and the sensor will return to normal mode.
2. Press the Timeclock (back) button to return to the Daylight Sensor screen. Use the Master buttons to highlight “Calibrate” and press the OK button to accept.
3. Use the Master buttons to select the desired zone and press the OK button to accept.
4. Use the Master buttons to select the desired light level for the zone, and press the OK button to accept. Repeat for all zone levels you wish to calibrate.
5. Exit programming mode.
Note: If wireless sensors are not found, verify that they are associated correctly.

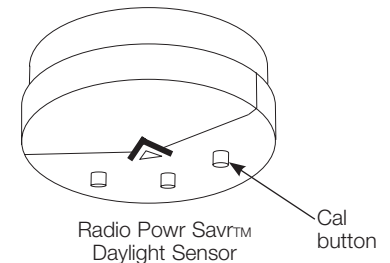
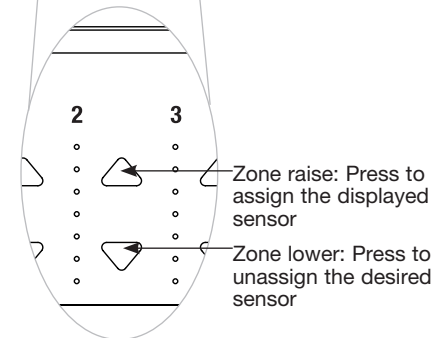
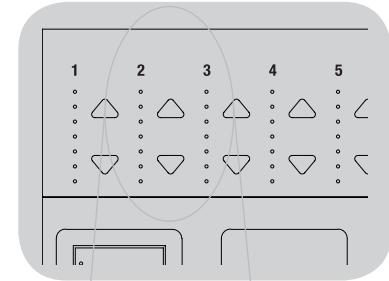
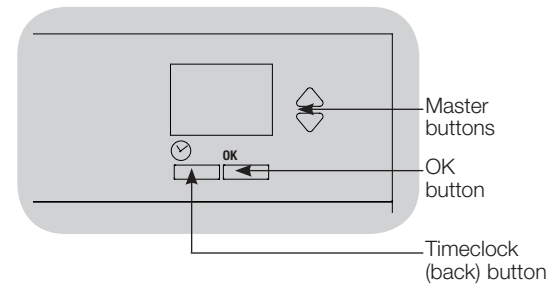
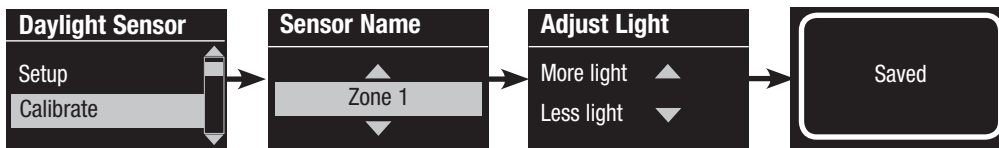

Daylight Sensor Setup

Labeling a Daylight Sensor (optional)

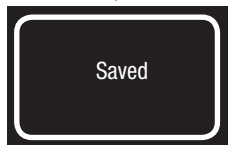
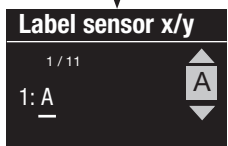
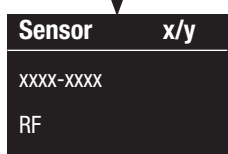
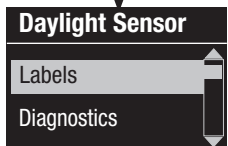
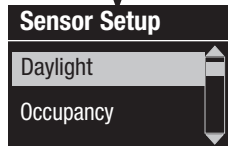
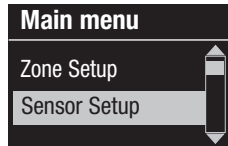

1. Enter programming mode.
2. Use the Master buttons to highlight “Sensor Setup” and press the OK button to accept.
3. Use the Master buttons to highlight “Daylight” and press the OK button to accept.
4. Use the Master buttons to highlight “Labels” and press the OK button to accept.
5. Use the Master buttons to display a daylight sensor to label and press OK to select.
6. Use the Master buttons to scroll through the characters (lowercase and uppercase letters, plus numbers 0 through 9). The character you are currently changing will be underlined on the screen. Press OK to select the character you want, then repeat for all available characters. Choose a space (no character) and press OK for any remaining characters. The info screen will confirm that your name has been saved. Repeat for all desired sensors.
7. Exit programming mode.

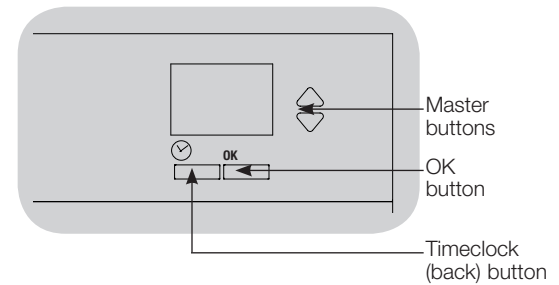

Pico® Wireless Control Setup

Lutron's Pico® wireless controls can be associated with a GRAFIK Eye® QS system to control the light level of a specific zone or to act as a scene controller. Pico wireless controls can be associated directly to GRAFIK Eye® QS Wireless control units, or to a wired or wireless GRAFIK Eye® QS control unit via a QS Sensor Module (QSM) wired on the QS link.

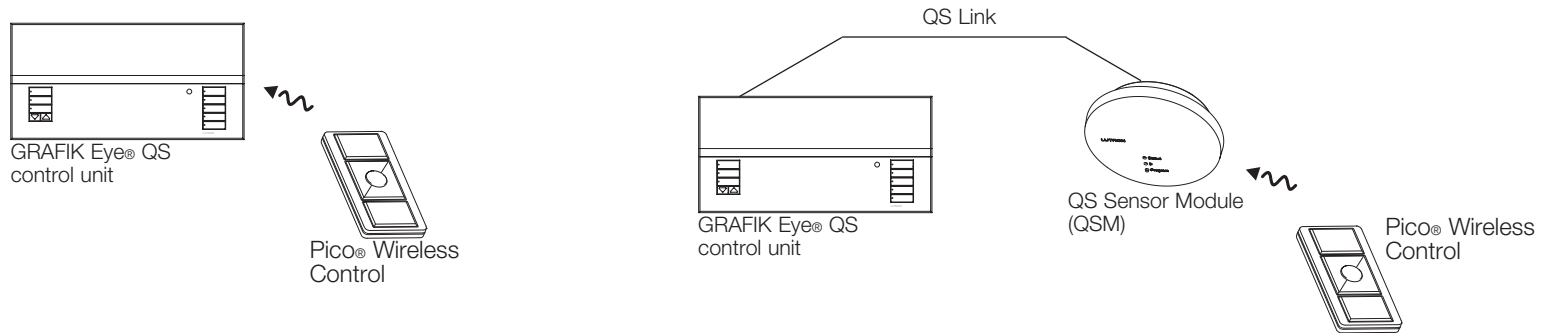

Available Pico® Wireless Control Models

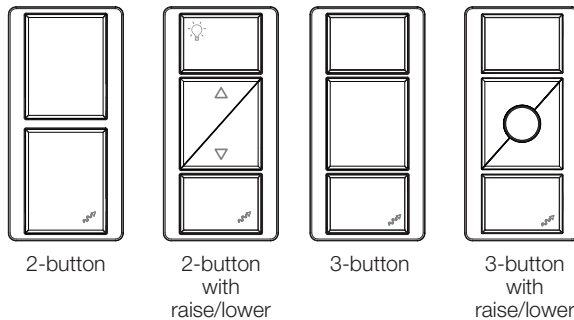

Functionality of the Pico® wireless control

	Zone Function	Scene Function
Top (On) Button	All assigned zones 100%	Scene 1
Center (Preset) Button (if available)	All assigned zones at programmed preset level (Press and hold to save current levels on assigned zone as preset)	Scene 16
Raise/Lower Buttons (if available)	Vary intensity of all assigned zones	Vary intensity of all zones affected by current scene
Bottom (Off) Button	All assigned zones Off	Scene Off

Pico® Wireless Control Setup

Associating the Pico® wireless control with a GRAFIK Eye® QS Wireless control unit:
(for wireless enabled GRAFIK Eye® QS control units only)

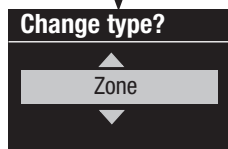
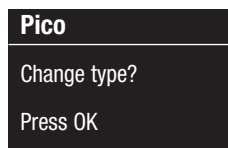

OR

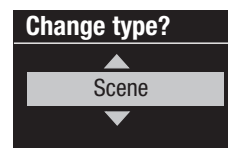

1. Make sure the wireless mode of the GRAFIK Eye® QS control unit is “Enabled”.
2. On the Pico® wireless control, press and hold the top (on) and bottom (off) buttons for 3 seconds. The info screen on the GRAFIK Eye® QS control unit will display the Pico® options. Press the OK button on the GRAFIK Eye® QS control unit to select the desired operation type for the Pico®.
- 3a. To assign the Pico® wireless control as a zone controller, use the Master buttons to select “Zone” and press the OK button to accept. Use the zone raise/lower buttons for a zone to select a desired preset level, and then press the zone raise and lower buttons simultaneously for 1 second (until the zone LEDs flash at the programmed preset level). Repeat for all zones you wish to control with the Pico® wireless control.
- OR
- 3b. To assign the Pico® wireless control as a scene controller, use the Master buttons to select “Scene” and press the OK button to accept. Press and hold the top scene button on the GRAFIK Eye® QS control unit for 3 seconds (until the scene LEDs flash).
4. On the Pico® wireless control, press and hold the top and bottom buttons for 3 seconds until the LEDs on the GRAFIK Eye® QS control unit stop flashing.

Note: The wireless signal has a range of 9 m through standard construction or 18 m line of sight.

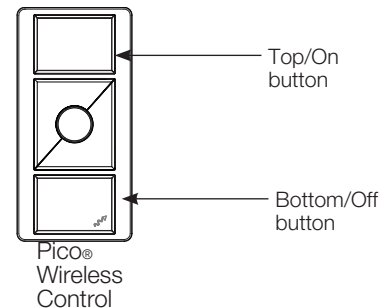
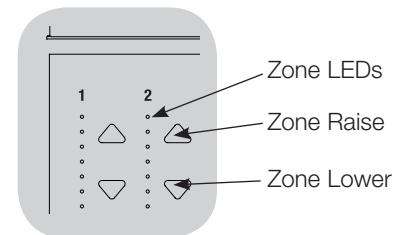
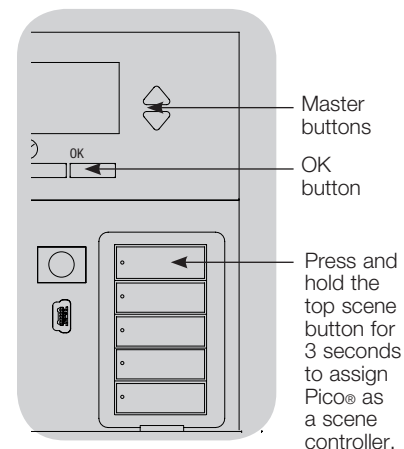

Pico® Wireless Control Setup

Associating the Pico® wireless control through a QS Sensor Module (QSM): (for wired or wireless enabled GRAFIK Eye® QS control units)



1. Press and hold the Program button on the QSM for 3 seconds to enter programming mode. There will be 1 audible beep and the Status LED will begin flashing. The info screen on the GRAFIK Eye® QS control unit will display that the QSM is in programming mode.
2. Press and hold the bottom button on the Pico® wireless control for 6 seconds. There will be 3 audible beeps from the QSM to verify association.
3. Press and hold the Program button on the QSM for 3 seconds to exit programming mode.
4. On the Pico® wireless control, press and hold the top (on) and bottom (off) buttons for 3 seconds, until the LEDs on the GRAFIK Eye® QS control unit begin to flash and the QSM beeps 1 time. Press the OK button on the GRAFIK Eye® QS control unit to select the desired operation mode for the Pico® wireless control.

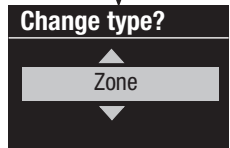

- 5a. To assign the Pico® wireless control as a zone controller, use the Master buttons to select "Zone" and press the OK button to accept. Use the zone raise/lower buttons for a zone to select a desired preset level, and then press the zone raise and lower buttons simultaneously for 1 second (until the zone LEDs flash at the programmed preset level). Repeat for all zones you wish to control with the Pico® wireless control.

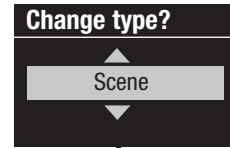

- OR
- 5b. To assign the Pico® wireless control as a scene controller, use the Master buttons to select "Scene" and press the OK button to accept. Press and hold the top scene button on the GRAFIK Eye® QS control unit for 3 seconds (until the scene LEDs flash).



6. On the Pico® wireless control, press and hold the top and bottom buttons for 3 seconds until the LEDs on the GRAFIK Eye® control unit stop flashing and the QSM beeps 1 time.

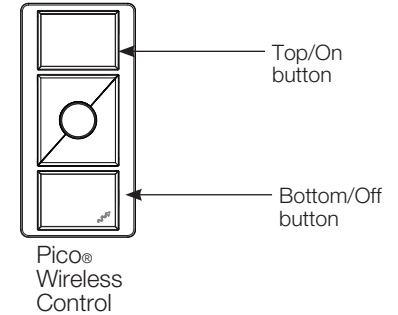
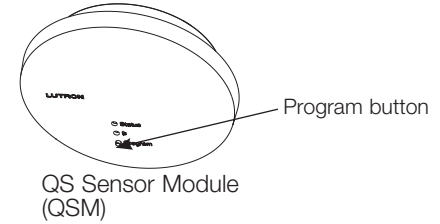

IR Setup

An infrared (IR) remote can directly control the GRAFIK Eye® QS control unit through the infrared receiver on the front of the GRAFIK Eye® QS control unit.

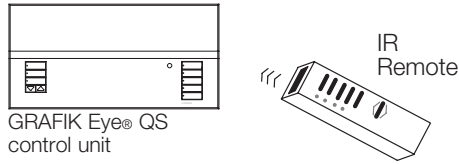

An externally powered IR repeater can also be connected to the IR terminals on the GRAFIK Eye® QS control unit to obtain IR remote control. This is useful for integrating third party devices with the GRAFIK Eye® QS control unit (e.g. home theater applications.) For a complete list of the GRAFIK Eye® QS control unit's IR programming commands, please see www.lutron.com/qs.

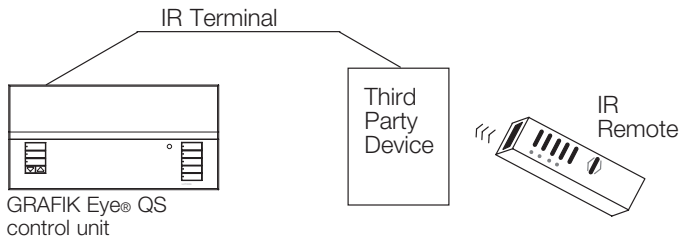

An IR remote can also indirectly control the GRAFIK Eye® QS control unit through the QS IR Eye or a Lutron® IR receiver wired to a QS Sensor Module (QSM) to control the light level of a specific zone or to act as a scene controller. The QS IR Eye and IR receivers wired to the QSM must first be associated with the GRAFIK Eye® QS control unit before they will be recognized by a GRAFIK Eye® QS system.

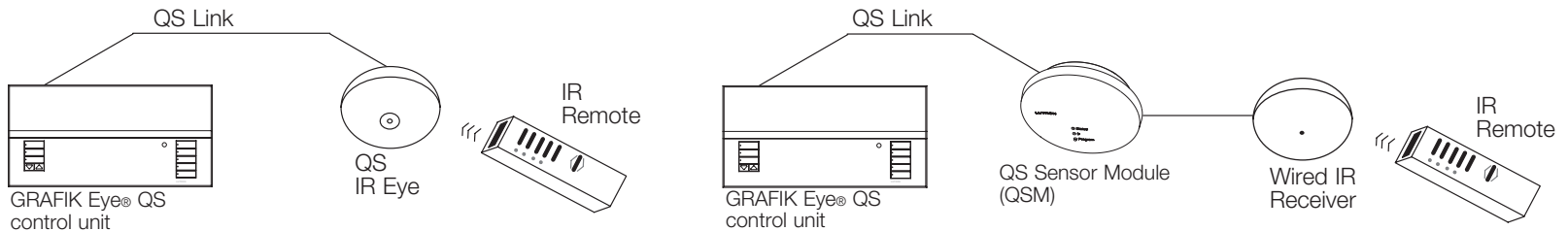

IR Setup

Enabling/disabling the IR receiver on the GRAFIK Eye® QS control unit:

Note: These steps will also enable or disable the IR terminals on the GRAFIK Eye® QS control unit.

1. Enter programming mode.
2. Use the Master buttons to highlight “IR Setup” and press the OK button to accept
3. Use the Master buttons to highlight “Integral IR” and press the OK button to accept.
4. Use the Master buttons to highlight either “Enabled” or “Disabled” and press the OK button to accept. The info screen will confirm that your settings have been saved.
5. Exit programming mode.

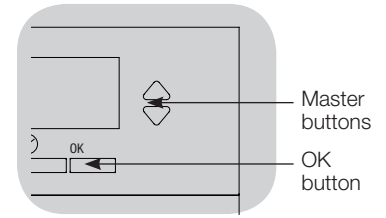
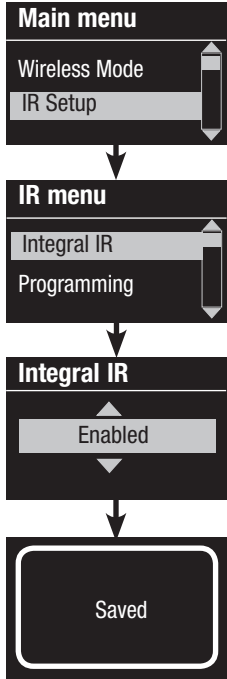

IR Setup

The QS IR Eye offers advanced programmable scene control depending on the IR remote being used. Use the chart below to select the appropriate control mode on the GRAFIK Eye® QS control unit:

IR Remote	Control Mode
GRX-IT	4 Buttons & Off or 5 Buttons
GRX-8IT	8 Buttons & Off
MIR-ITFS	Favorite or Zone control
C-FLRC	Favorite or Zone control
Third Party IR Remote	Default

Associating the QS IR Eye with a GRAFIK Eye® QS control unit:

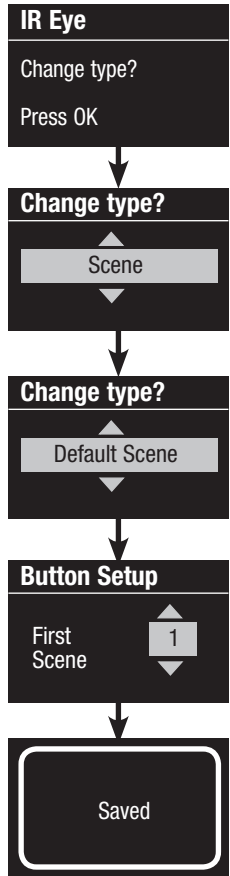

Note: For use with Lutron remote models GRX-IT and GRX-8IT, or with third-party IR remotes.

1. Point the IR remote at the QS IR Eye. To enter programming mode, press and hold the top and bottom buttons on the remote for 3 seconds until the LED on the QS IR Eye begins to flash slowly.
2. Press and hold the top scene button on the GRAFIK Eye® QS control unit for 3 seconds. The scene LEDs will flash to confirm that the QS IR Eye has been associated. Press the OK button to continue.
3. Use the Master buttons to select “Scene” and press the OK button to accept.
4. Use the Master buttons to select one of the scene control types (listed below) to correspond to the IR remote that will be used with the QS IR Eye. Press the OK button to accept.

If “Default” was not selected, the info screen will prompt you to select which scene will correspond to the top button of the IR remote. Use the Master buttons to select the desired scene, and press the OK button to accept. The info screen will confirm that your settings have been saved.

Note: The “Default” scene control type will activate whichever scene command is transmitted to the GRAFIK Eye® QS control unit.

5. Point the IR remote at the QS IR Eye. To exit programming mode, press and hold the top and bottom buttons on the remote for 3 seconds.

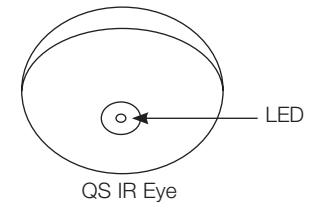
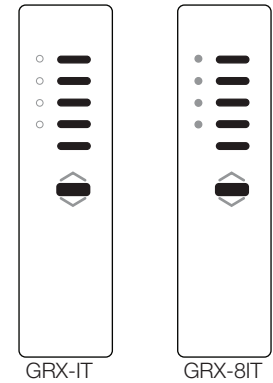
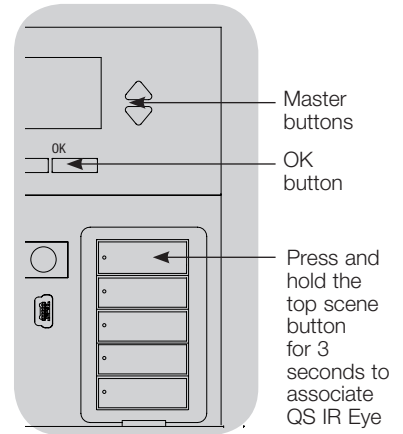

IR Setup

Associating the QS IR Eye with a GRAFIK Eye® QS control unit (continued):

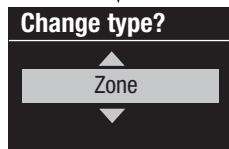
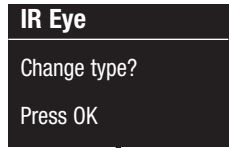

OR

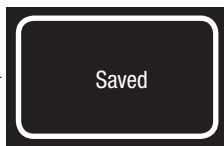
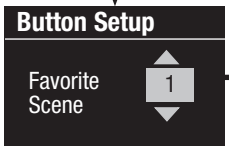
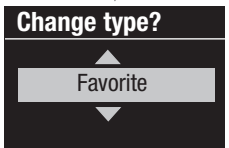
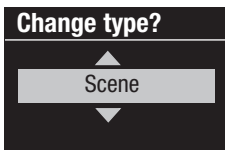

Note: For use with Lutron® remote models MIR-ITFS and C-FLRC.

1. Point the IR remote at the QS IR Eye. To enter programming mode, press and hold the “On” (top) button on the remote for 5 seconds, then, within 1 second, press and hold the “Off” (bottom) button on the remote for 5 seconds. The LED on the QS IR Eye will begin to flash slowly. Press the OK button on the GRAFIK Eye® QS control unit to continue.
- 2a. To assign the QS IR Eye as a zone controller, use the Master buttons to select “Zone” and press the OK button to accept. Use the zone raise/lower buttons on the GRAFIK Eye® QS control unit to select a desired preset level, then press the zone raise and lower buttons simultaneously for 1 second (until the zone LEDs flash at the programmed preset level). Repeat for all zones you wish to assign to the QS IR Eye. The info screen will confirm that your settings have been saved.

OR

- 2b. To assign the QS IR Eye as a scene controller, use the Master buttons to select “Scene” and press the OK button to accept. Use the Master buttons to select your desired favorite scene, and press the OK button to accept. Press and hold the top scene button on the GRAFIK Eye® QS control unit for 3 seconds (until the scene LEDs flash). The info screen will confirm that your settings have been saved.
3. Point the IR remote at the QS IR Eye. To exit programming mode, press and hold the “On” (top) button on the remote for 5 seconds, then, within 1 second, press and hold the “Off” (bottom) button on the remote for 5 seconds.

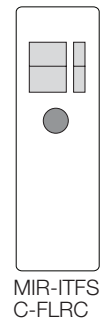
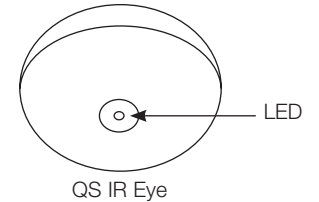
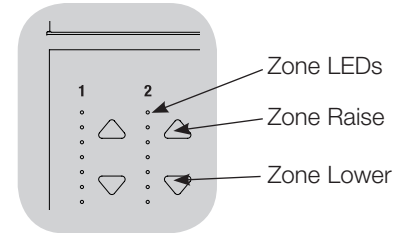
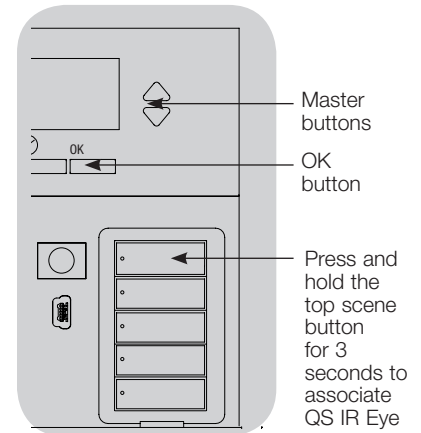

IR Setup

Associating IR receivers through a QS Sensor Module (QSM):

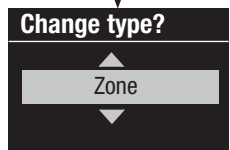
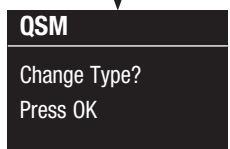
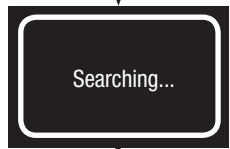
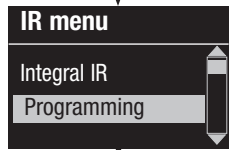
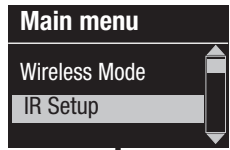

1. Upon power up, the QSM will automatically detect and configure wired IR receivers after a valid signal is received. Use an IR remote to send a signal to all connected receivers in the system.
2. Enter programming mode on the GRAFIK Eye® QS control unit.
3. Use the Master buttons to highlight “IR Setup” and press the OK button to accept
4. Use the Master buttons to highlight “Programming” and press the OK button to accept. The info screen will display “Searching” while the unit detects available infrared receivers.
5. Use the Master buttons to scroll through the list of available infrared receivers (the displayed IR receiver will flash). When the desired IR receiver is displayed, press the OK button to select it. Press the OK button again to continue.
- 6a. To assign the IR receiver as a zone controller, use the Master buttons to select “Zone” and press the OK button to accept. Use the zone raise/lower buttons for a zone to select a desired preset level, then press the zone raise and lower buttons simultaneously for 1 second (until the zone LEDs flash at the programmed preset level). Repeat for all zones you wish to control with the IR receiver.
- OR
- 6b. To assign the IR receiver as a scene controller, use the Master buttons to select “Scene” and press the OK button to accept. Press and hold the top scene button on the GRAFIK Eye® QS control unit for 3 seconds (until the scene LEDs flash).
7. Press the Timeclock (back) button twice to return to the list of available IR receivers and repeat as needed.
8. Exit programming mode on the GRAFIK Eye® QS control unit.

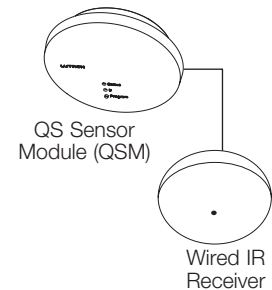
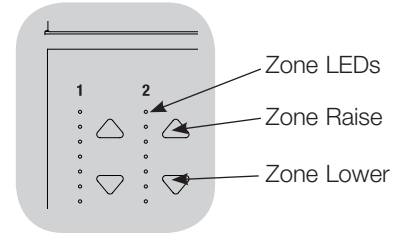
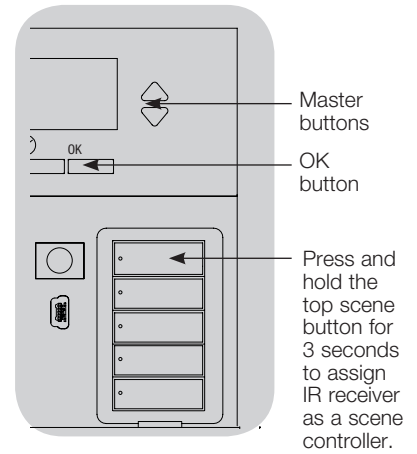
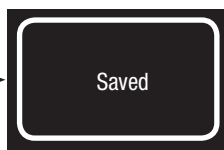
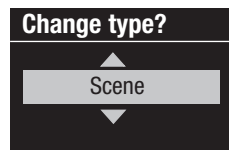

Associating Sivoia® QS Window Treatments and GRAFIK Eye® QS Control Units

When a GRAFIK Eye® QS system consists of Sivoia® QS window treatments (shades) and a GRAFIK Eye® QS with one or more shade button groups, you can associate the shade button groups on the control unit with the window treatments so the shade buttons can directly control the window treatments.

For Sivoia® QS Window Treatments wired directly to the GRAFIK Eye® QS control unit:

To **associate** or **disassociate** window treatments with a shade button group:

1. On the GRAFIK Eye® QS control unit shade button group you wish to assign window treatments to, enter window treatment programming mode: Press and hold the top (open) and bottom (close) buttons simultaneously for 3 seconds. The top and bottom LEDs will flash. Window treatments that are unassigned will move to up (open), and window treatments that are assigned will move to close (down).
 2. Tap the top (open) button to start assigning.
 3. Tap the top (open) button repeatedly to cycle forward through the addresses; tap the bottom (close) button to cycle backward.
 4. Press the shade group **lower** button to associate the window treatment. Press the shade group **raise** button to **disassociate** the window treatment.
- 
- Lower button: Press to associate
Raise button: Press to disassociate
5. Exit window treatment programming mode: Press and hold the top (open) and bottom (close) buttons simultaneously for 3 seconds. The top and bottom LEDs will stop flashing.

For Wireless Sivoia® QS Window Treatments:

To **associate** window treatments with a shade button group:

1. Make sure the wireless mode of the GRAFIK Eye® QS control unit is “Enabled”.
2. On the GRAFIK Eye® QS control unit shade button group you wish to assign window treatments to, enter window treatment programming mode: Press and hold the top (open) and bottom (close) buttons simultaneously for 3 seconds. The top and bottom LEDs will flash.
3. The LEDs on the electronic drive unit (EDU) and the wireless antenna of unassociated window treatments will blink slowly. On the window treatment that you wish to associate with the shade button group, tap any button; the LED on the EDU will blink rapidly to indicate the window treatment is now associated with the shade button group on the GRAFIK Eye® QS control unit.
4. Repeat step 2 to associate additional window treatments to that shade button group.
5. Exit window treatment programming mode: Press and hold the top (open) and bottom (close) buttons simultaneously for 3 seconds. The top and bottom LEDs will stop flashing.
6. Repeat steps 1 through 5 for additional shade button groups, as applicable.

To **disassociate** window treatments with a shade button group:

Repeat, in the same order, the steps above for associating window treatments. When in window treatment programming mode, tap any button on the electronic drive unit (EDU) of the window treatments that you wish to disassociate from the shade button group; the green LEDs on the EDU and antenna will blink slowly to indicate the window treatment is disassociated from the shade button group on the GRAFIK Eye® QS control unit.

Note: The wireless signal has a range of 9 m through standard construction or 18 m line of sight.

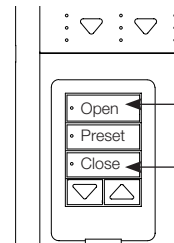

Press and hold the top (open) and bottom (close) buttons on the GRAFIK Eye® QS control unit shade button group to enter or exit window treatment programming mode.

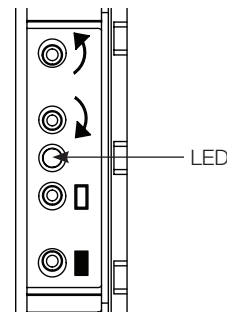

Sivoia® QS Wireless window treatment EDU

Adjusting Window Treatment Settings (for Wired and Wireless Sivoia® QS Window Treatments)

Setting Limits

(for wired window treatments only)

Note: Entering Limit Setup mode may cause window treatments to move approximately 200 mm up or down. **Be sure that each window treatment is positioned so that the fabric can safely move 200 mm up or down before entering Limit Setup mode.**

1. On any shade button group, press and hold simultaneously the top and raise buttons. The LEDs next to the top and bottom buttons will cycle.

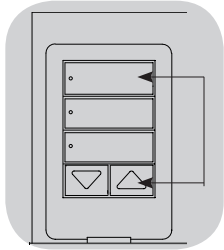

At any time while in Limit Setup mode, you can move all window treatments together to their current open limit by double-tapping the top button, or to their current close limit by double-tapping the bottom button.

Note: Window treatment electronic drive units (EDUs) must first be associated to a shade button group before its limits can be adjusted.

2. Select the EDU you want to adjust using the top button on the shade button group. Each time you press and release the top button, a different EDU that is assigned to that shade button group will open and close in an 200 mm range to indicate it is selected.

Tap the top button until the EDU for the window treatment you wish to adjust moves. (You can also use the bottom button, which moves through the assigned EDUs in the opposite order.)

3. Adjust the currently selected EDU to the desired level for the open limit (the maximum the window treatment is allowed to open) using the raise and lower buttons.

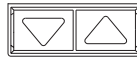

4. Press and hold the top button on the shade button group for 5 seconds to store the current position as the open limit. The LED next to the top button will flash quickly for 2 seconds.
5. Adjust the currently selected EDU to the desired level for the close limit (the maximum the window treatment is allowed to close) using the raise and lower buttons.
6. Press and hold the bottom button on the shade button group for 5 seconds to store the current position as the close limit. The LED next to the bottom button will flash quickly for 2 seconds.

7. Repeat steps 2 through 6 to set the open and close limits for each window treatment assigned to the shade button group.
8. Press and hold simultaneously the top and raise buttons on the shade button group to exit Limit Setup mode.

Note: Remote limits cannot be set for Sivoia® QS wireless window treatments through the GRAFIK Eye® QS control unit. Limits must be set manually at the wireless window treatment EDU. (See the Sivoia® QS wireless shade instructions.)

Adjusting Window Treatment Settings (for Wired and Wireless Sivoia® QS Window Treatments)

Preset Adjustment: Simple Method

1. Use the raise and lower buttons on the shade button group to set all electronic drive units (EDUs) of the window treatments to the desired preset levels.



2. Press and hold the middle button on the shade button group for 5 seconds to save the EDU preset positions. The LED next to the button will flash and then light continuously, indicating the preset has been stored.

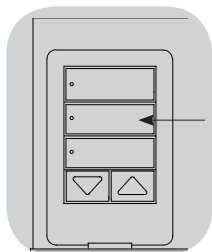

Note: Once EDU presets have been assigned to buttons on a shade button group, those presets are accessible for an EDU only using the shade button group it is assigned to, and a shade button group can access preset levels only for those EDUs assigned to it.

Preset Adjustment: Advanced Method

- The advanced method for adjusting presets is needed only if you wish to have the window treatments assigned to the shade button group set at different positions in the preset. If, however, you wish all the window treatments in the group to be lined up with one another in the preset, you should use the Simple Method at left.
- Entering Assignment mode will cause the window treatments to move between their open and close limits. **Verify that the open and close limits have been set correctly.**

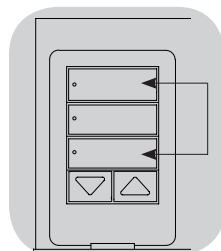

1. On the shade button group whose preset you wish to adjust, press and hold simultaneously the top and bottom buttons. The LEDs next to the buttons will flash. EDUs for the assigned window treatments will move to their closed limits, and EDUs for unassigned window treatments will move to their open limits.
2. Press and release the middle button on that shade button group. The adjacent LED will blink rapidly. EDUs for assigned window treatments will automatically move to their current preset settings.

3. Use the raise and lower buttons to move all EDUs for assigned window treatments together to the desired preset setting.

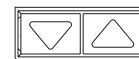

4. To move an EDU individually to its desired preset setting, select the EDU using the top button on the shade button group. Each time you press and release the top button, a different EDU that is assigned to that shade button group will open and close in an 200 mm range. Press repeatedly until the EDU for the window treatment you wish to adjust moves. Adjust that EDU to the desired height using the raise and lower buttons. Repeat this step for all assigned EDUs.
5. Once you are satisfied that all the assigned EDUs are set to the positions you want to assign as the preset, press and hold the middle button on the shade button group for 5 seconds. The preset will be saved.
6. Press and hold simultaneously the top and bottom buttons on the shade button group for 5 seconds to exit to normal mode. The LEDs next to the buttons will stop flashing.

Adjusting Window Treatment Settings

(for Wired and Wireless Sivoia® QS Window Treatments)

Naming a Group of Shades (Window Treatments)

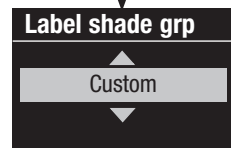
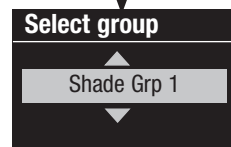
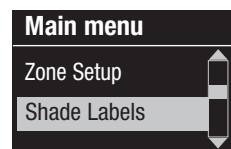

1. Enter programming mode.
2. Use the Master buttons to highlight “Shade Labels” and press the OK button to accept.
3. Use the Master buttons to highlight your desired window treatment group. Press the OK button to accept.
4. Use the Master buttons to highlight “Custom” and press the OK button to accept.
5. Use the Master buttons to scroll through the characters (lowercase and uppercase letters, plus numbers 0 through 9). The character you are currently changing will be underlined on the screen. Press OK to select the character you want, then repeat for all available characters. Choose a space (no character) and press OK for any remaining characters. Press the OK button to accept.
6. The info screen will confirm that your name has been saved.
7. Exit programming mode.

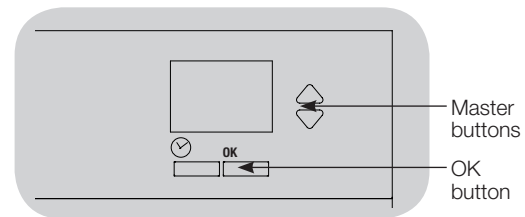

Associating Multiple GRAFIK Eye® QS Control Units

When there is more than one GRAFIK Eye® QS control unit in a system, it is often convenient to associate them so that certain functions carry over to other associated GRAFIK Eye® QS control units.

- **Wired units:** When first wired on the QS link, all unprogrammed GRAFIK Eye® QS wired control units will replicate scene activations and Master button presses by other control units on the link. Associating or disassociating control units determines which units on the QS link will “talk” or “listen” to each other. Control units associated on a wired QS link will also replicate timeclock and contact closure settings.
- **Wireless units:** GRAFIK Eye® QS Wireless control units will not automatically replicate scene activations or Master button presses, and must be programmed to do so. (Associating two wireless control units will not pass timeclock and contact closure settings to each other.) When associating multiple wireless control units, make sure the wireless mode of both units is set to “Enabled.”

Note: The wireless signal has a range of 9 m through standard construction or 18 m line of sight.

To associate two GRAFIK Eye® QS control units:

1. Begin with the GRAFIK Eye® QS control unit that will “talk” (button presses will be replicated on the other control unit; in the drawing below this is GRAFIK Eye® QS control unit A). Press and hold the top and bottom scene buttons until the LEDs flash (about 3 seconds).
2. Continue with the GRAFIK Eye® QS control unit that will “listen” (replicate button presses on the other control unit; in the drawing below this is GRAFIK Eye® QS control unit B). Press and hold the top scene button until the LEDs flash (about 3 seconds).
3. Return to the GRAFIK Eye® QS control unit that will “talk” (A). Press and hold the top and bottom scene buttons until the LEDs stop flashing (about 3 seconds).
4. Repeating the process in reverse allows GRAFIK Eye® QS control unit A to also “listen” to GRAFIK Eye® QS control unit B, so that both units will follow each other.

To disassociate two GRAFIK Eye® QS control units:

Simply repeat the association steps, in the same order; press and hold the bottom scene button on B to disassociate.

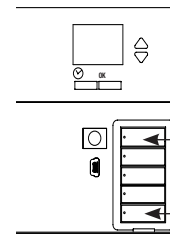

On the unit that will “talk”, press and hold the top and bottom scene buttons for 3 seconds to begin or end association or disassociation with the unit that will “listen”.

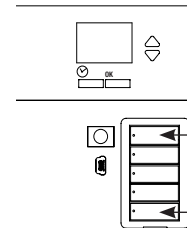

On the unit that will “listen”, press and hold the top scene button for 3 seconds to associate, or press and hold the bottom scene button for 3 seconds to disassociate with the unit that will “talk”.

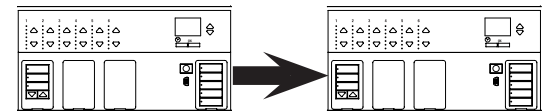

GRAFIK Eye® QS control unit A
“Talks” to GRAFIK Eye® QS control unit B; scene activation and Master button presses activated on control unit A are replicated on control unit B.

GRAFIK Eye® QS control unit B
“Listens” to GRAFIK Eye® QS control unit A; control unit B replicates scene activations and Master button presses on control unit A.

Timeclock Operation

Setting Time and Date

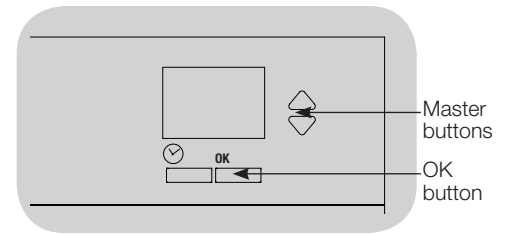
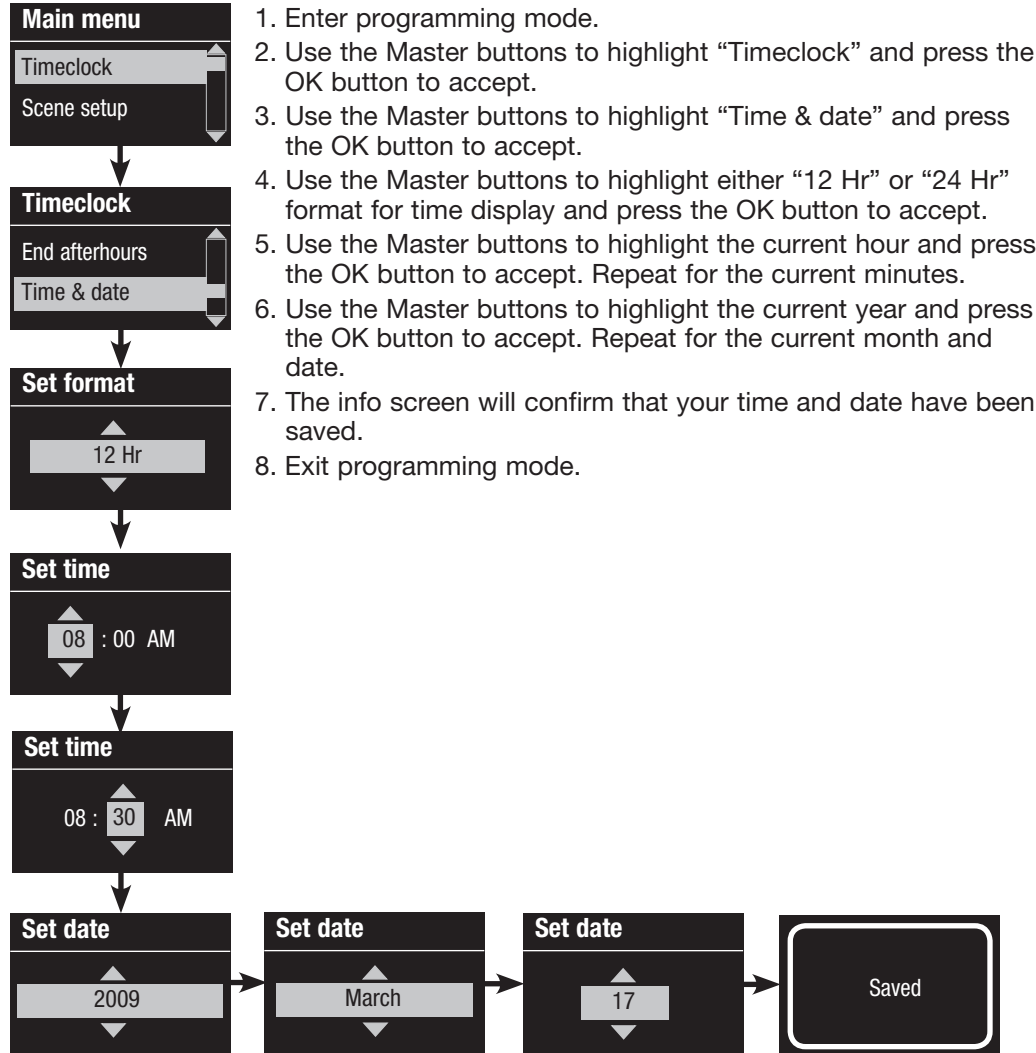

Timeclock Operation

Setting Location

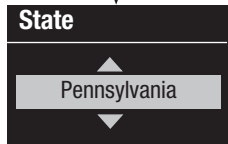
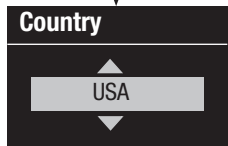
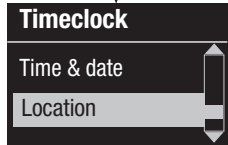
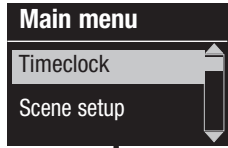

1. Enter programming mode.
2. Use the Master buttons to highlight "Timeclock" and press the OK button to accept.
3. Use the Master buttons to highlight "Location" and press the OK button to accept.
4. Use the Master buttons to set your location by either country and city or latitude and longitude. Press the OK button to accept.
5. Use the Master buttons to highlight the country and press the OK button to accept. Repeat for the state and closest city.
6. The info screen will confirm that your time and date have been saved.
7. Exit programming mode.

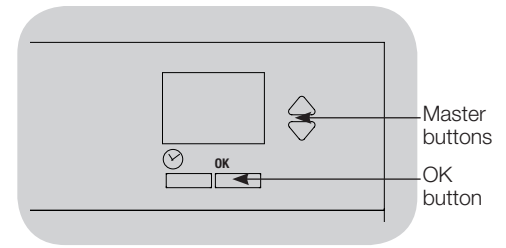
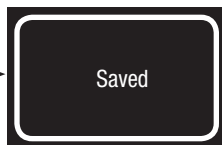

Setting Daylight Saving Time

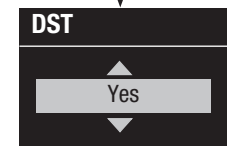
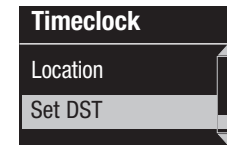

1. Enter programming mode and select "Timeclock". Use the Master buttons to highlight "Set DST" and press the OK button to accept.
2. Use the Master buttons to highlight "YES" if your location observes daylight saving time, or "NO" if it does not. Press the OK button to accept.
3. If yes, use the Master buttons to choose either "USA 2007" (the second Sunday in March to the first Sunday in November), or "Other." For "Other," follow the screens to set start and end dates and amount of time.
4. Press the OK button to accept. The info screen will confirm that your time and date have been saved.
5. Exit programming mode.

Timeclock Operation

Adding an Event

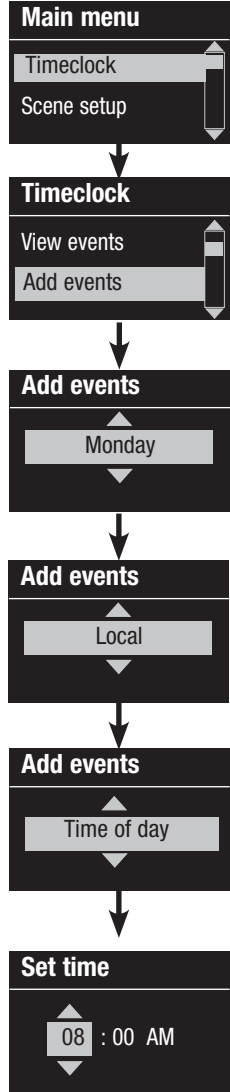

1. Enter programming mode.
2. Use the Master buttons to highlight “Timeclock” and press the OK button to accept.
3. Use the Master buttons to highlight “Add events” and press the OK button to accept.
4. Use the Master buttons to highlight the recurrence for this event: day of the week, holiday, weekdays or weekends. Press the OK button to accept.
5. Use the Master buttons to highlight the location of the timeclock event (local or remote). Press the OK button to accept.
 - Local events affect scenes controlled by the GRAFIK Eye® QS Control Unit
 - Remote events affect scenes controlled by another device on the QS link (e.g. Energi Savr Node™ QS)

Note: Remote timeclock events provide a virtual timeclock to devices on the QS link without a built-in timeclock. This allows the GRAFIK Eye® QS control unit to activate scenes on other devices without affecting the space it controls.
6. Use the Master buttons to highlight the type of the event (fixed time of day or a relative time to sunrise or sunset). Press the OK button to accept.
7. For a fixed-time event, use the Master buttons to highlight the hour for your event to begin; press the OK button to accept. Repeat for the minutes. For a relative time event, use the Master buttons and the OK button to set the hour, then the minutes relative to sunrise or sunset (maximum of 1 hour, 59 minutes before or after sunrise or sunset).
8. Use the Master buttons to highlight the desired action for the timeclock event:
 - Scenes 1-16, Off
 - Shade (Window Treatment) Groups 1-3 open, preset, or close
 - Start/End Afterhours
 - Enable/Disable Occupancy
 - Enable/Disable Occupied Events
 - Enable/Disable Daylighting
9. The info screen will confirm that your event has been saved.
10. Repeat steps 4 through 9 for additional events.
11. Exit programming mode.

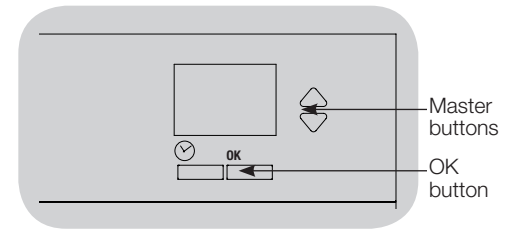

Timeclock Operation

Deleting an Event



1. Enter programming mode.
2. Use the Master buttons to highlight “Timeclock” and press the OK button to accept.
3. Use the Master buttons to highlight “Delete events” and press the OK button to accept.
4. Use the Master buttons to highlight the day of the week (or holiday) when the event occurs; press the OK button to accept.
5. Use the Master buttons to highlight the event to delete; press the OK button to accept.
6. A screen will appear, verifying you wish to delete the event. Press the OK button to accept and delete; otherwise, press the timeclock button to go back.
7. The info screen will confirm that your event has been deleted.
8. Exit programming mode.

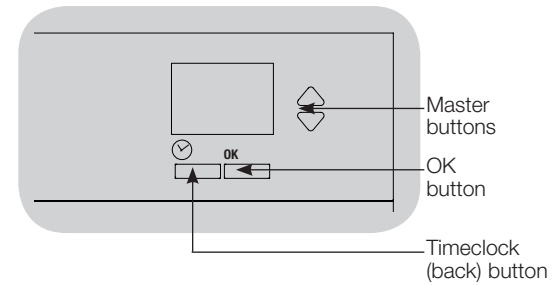

Viewing an Event

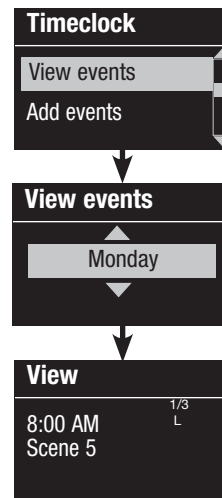

1. Enter programming mode, select “Timeclock,” and select “View events”.
2. Use the Master buttons to highlight the day of the week (or holiday) when the event occurs; press the OK button to accept.
3. Use the Master buttons to highlight the event to view; press the OK button to accept.
4. Press the OK button to return to the Timeclock menu.
5. Exit programming mode.

Timeclock Operation

Setting a Holiday

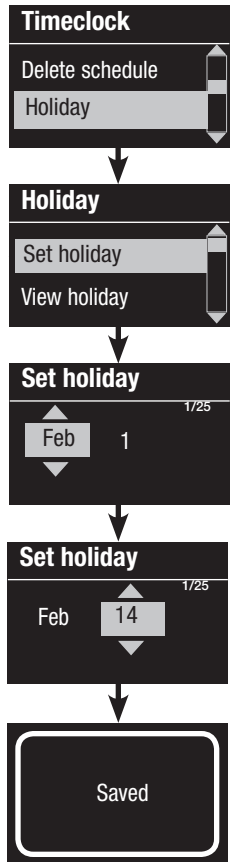

1. Enter programming mode.
2. Use the Master buttons to highlight “Timeclock” and press the OK button to accept.
3. Use the Master buttons to highlight “Holiday” and press the OK button to accept.
4. Use the Master buttons to highlight “Set holiday” and press the OK button to accept.
5. Use the Master buttons to highlight the month of the holiday and press the OK button to accept. Repeat for the date.
6. The info screen will confirm that your holiday has been set.
7. Exit programming mode.

Note: The GRAFIK Eye® QS control unit supports up to 25 unique holidays. Follow the steps in “Adding an Event” to add Holiday timeclock events.

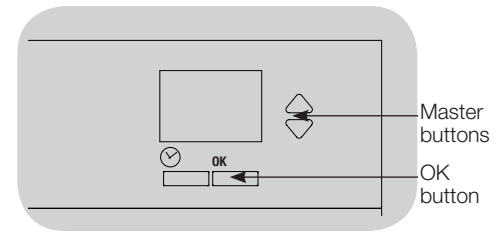

Viewing a Holiday

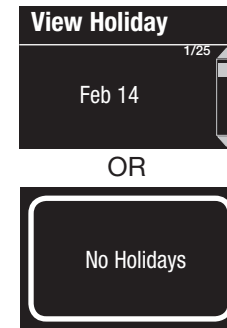

1. Enter programming mode, select “Timeclock,” select “Holiday,” and select “View holiday”.
2. Use the Master buttons to scroll through the dates of the programmed holidays.
3. If no holidays are programmed, the info screen will display a screen informing you.
4. Exit programming mode.

Deleting a Holiday

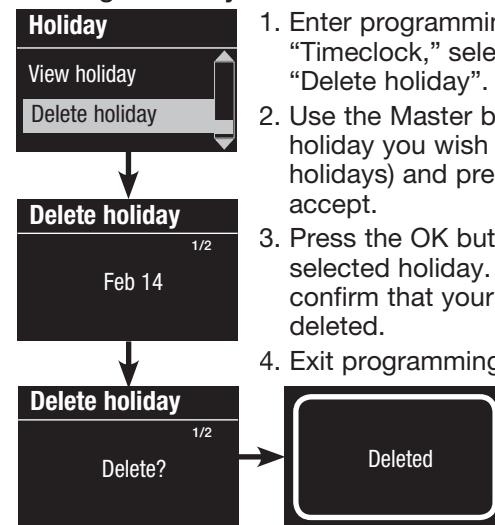

1. Enter programming mode, select “Timeclock,” select “Holiday,” and select “Delete holiday”.
2. Use the Master buttons to highlight the holiday you wish to delete (or delete all holidays) and press the OK button to accept.
3. Press the OK button to delete the selected holiday. The info screen will confirm that your holiday has been deleted.
4. Exit programming mode.

Timeclock Operation

Copying a Schedule

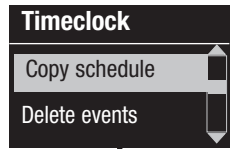

1. Enter programming mode.
2. Use the Master buttons to highlight "Timeclock" and press the OK button to accept.
3. Use the Master buttons to highlight "Copy Schedule" and press the OK button to accept.
4. Use the Master buttons to highlight the day you want to copy the schedule from and press the OK button to accept.
5. Use the Master buttons to highlight the day you want to copy the schedule to and press the OK button to accept.
6. The info screen will ask you to confirm overwriting all events occurring on the selected day to copy to; press the OK button to accept.
7. Exit programming mode.

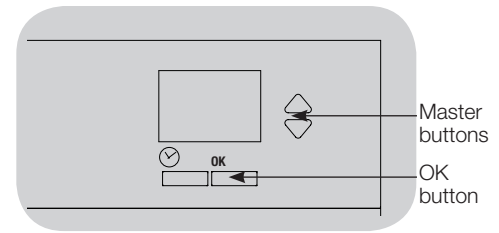
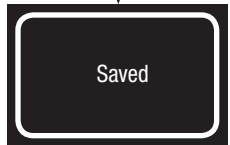
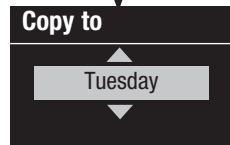
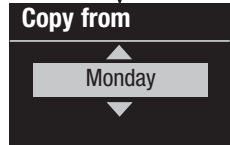

Deleting a Schedule

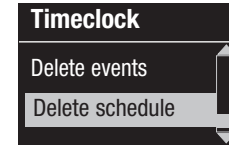

1. Enter programming mode, select "Timeclock," and select "Delete schedule".
2. Use the Master buttons to highlight the day of the schedule you wish to delete and press the OK button to accept.
3. The info screen will confirm that your event has been deleted.
4. The info screen will ask you to confirm deleting the schedule on the selected day; press the OK button to accept.
5. Exit programming mode.

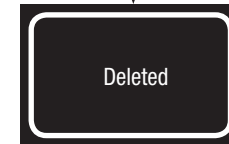
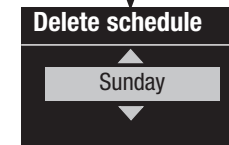

Afterhours

The Afterhours feature of the GRAFIK Eye® QS control unit can be used to automatically set lights to an energy-saving level (typically “Scene Off”). This feature allows occupants to manually turn on lights, but will automatically turn them off after a specified amount of time.

When Afterhours starts, the lights will flash to alert occupants that the lights will soon fade to the Afterhours Scene. Occupants then can press a keypad button to extend the time until the Afterhours feature flashes the lights again.

The Afterhours feature of the GRAFIK Eye® QS control unit has three (3) modes of operation:

- **Enabled:** The GRAFIK Eye® QS control unit will allow the Afterhours feature to be activated.
- **Follow:** The GRAFIK Eye® QS control unit will execute the Afterhours settings of another associated device on the QS link.
- **Disabled (default):** The GRAFIK Eye® QS control unit will not start the Afterhours feature (even if it receives commands from a Timeclock event, contact closure input, or another device on the QS link).

Note: The Afterhours feature must be programmed to start or end through Timeclock events, the integral contact closure input, or another associated device on the QS link. The GRAFIK Eye® QS control unit will activate this feature only if the Afterhours mode has been set to “Enabled” or “Follow”.

Afterhours Settings

Flash count: The amount of times the lights will flash to alert the room that the Afterhours Scene will soon be activated.

Range: 0 to 15 flashes (default 3 flashes)

Delay time: The amount of time after the end of the “Flash count” before the Afterhours Scene is activated.

Range: 1 to 180 minutes (default 15 minutes)

Warn time: The amount of time the system will wait after the Afterhours Scene is interrupted before flashing the lights again and restarting the Delay Time countdown.

Range: 1 to 180 minutes (default 5 minutes)

Afterhours scene: The scene that the GRAFIK Eye® QS control unit will activate when the Delay Time expires.

Range: Scenes 1 to 16, Off (default Scene 5)

(See example on the next page.)

Afterhours

Afterhours Examples

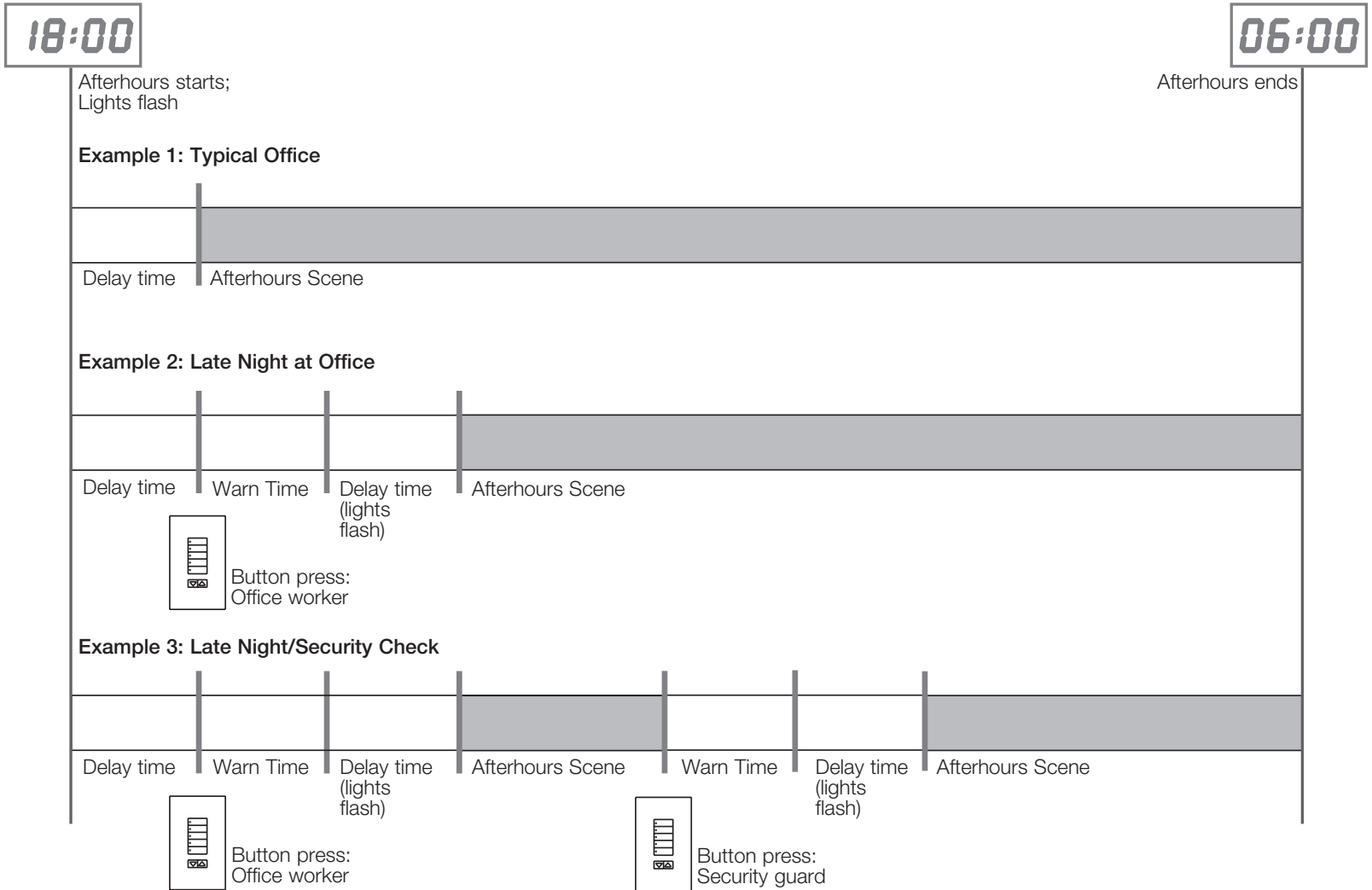

Afterhours

Setting Up Afterhours

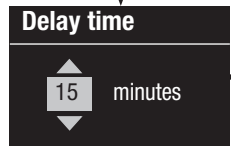
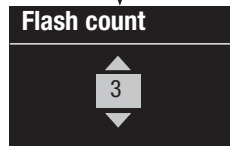
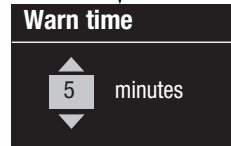
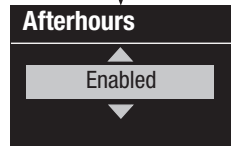
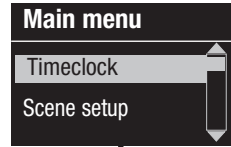

1. Enter programming mode.
2. Use the Master buttons to highlight “Timeclock”, and press the OK button to accept.
3. Use the Master buttons to highlight “Afterhours setup”, and press the OK button to accept.
4. Use the Master buttons to select the desired Afterhours mode, and press the OK button to accept.
5. (If the Afterhours mode was set to “Enabled”)
Use the Master buttons to highlight the desired values for Flash count, Delay time, Warn time, and Afterhours scene. Press the OK button to accept each setting. The info screen will confirm that your Afterhours settings have been saved.
6. Exit programming mode.

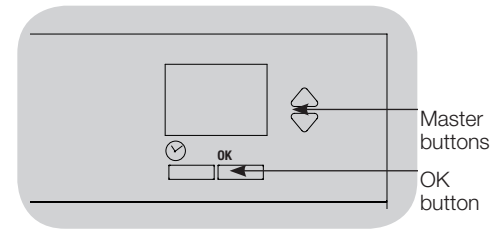
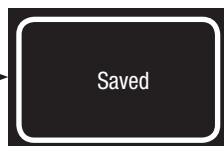
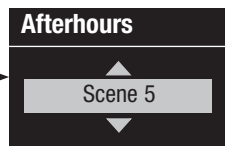

Ending Afterhours

Once activated, the Afterhours feature can be overridden at any time and ended through the programming menu.



1. Enter programming mode.
2. Use the Master buttons to highlight “Timeclock”, and press the OK button to accept.
3. Use the Master buttons to highlight “End Afterhours”, and press the OK button to accept. The info screen will confirm that afterhours mode is ended.
4. Exit programming mode.

Diagnostics and Special Settings

Enabling/Disabling the Timeclock

The timeclock can be enabled or disabled as desired.

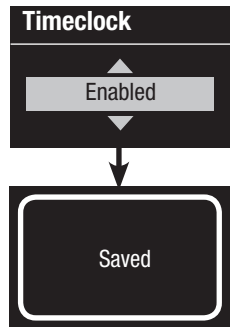

1. Enter programming mode. Use the Master buttons to select "Timeclock." Press the OK button to accept.
2. Use the Master buttons to highlight either "Enabled" or "Disabled". Press the OK button to accept. The info screen will confirm that your setting has been saved.
3. Exit programming mode.

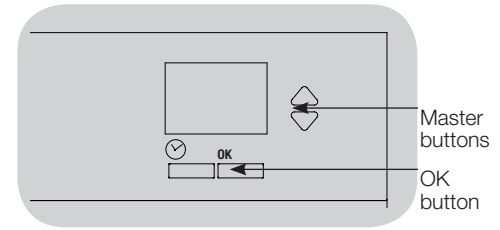

Enabling/Disabling the Backlighting

The backlighting on the info screen can be enabled or disabled as desired.

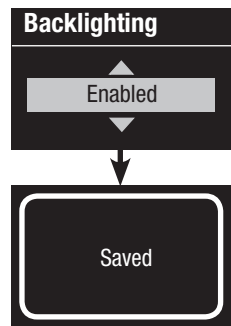

1. Enter programming mode and select "Backlighting". Press the OK button to accept.
2. Use the Master buttons to highlight either "Enabled" or "Disabled". Press the OK button to accept. The info screen will confirm that your setting has been saved.
3. Exit programming mode.

Diagnostics

If you are having trouble with your control unit and call Lutron Technical Support, you may be asked for diagnostic information about your unit.

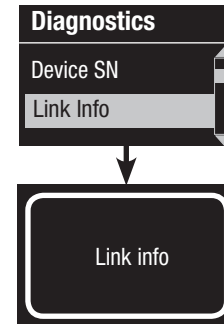

1. Enter programming mode and select "Diagnostics". Press the OK button to accept.
2. Use the Master buttons to highlight the option that will display the required information. The info screen can display the device serial number, link information, code version, or USB status. There is also an option to reset the USB connection (do this only if asked to by Lutron Technical Support).
3. Exit programming mode.

Diagnostics and Special Settings (continued)

Setting the Security Password

A four-digit password can be set as a security feature to protect the programming settings on the GRAFIK Eye® QS control unit.

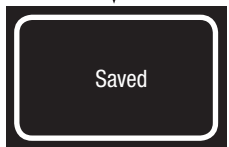
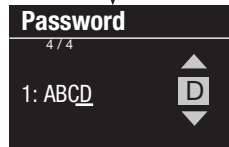
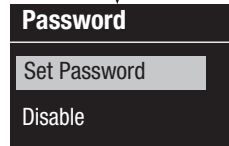
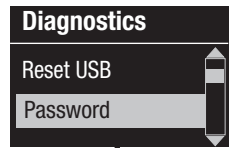

1. Enter programming mode
2. Select “Diagnostics” and press the OK button to accept.
3. Select “Password” and press the OK button to accept.
4. Select “Set Password” and press the OK button to accept.
5. You will be prompted to input a four-digit password. Use the Master buttons to scroll through the characters (uppercase letters and numbers 0 through 9 only). The character you are currently changing in the password will appear underlined on the info screen. Press OK to select the desired character, and repeat for the remaining characters. The info screen will confirm that your setting has been saved.
6. Exit programming mode.

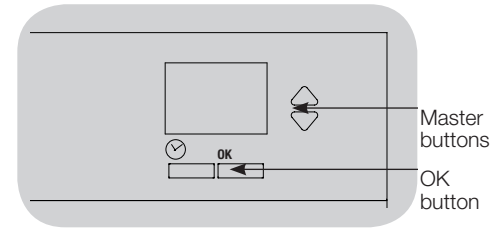

When you re-enter programming mode after setting your password, you will be prompted to enter your password. Use the method in Step 5 above to select and enter each character.

Note: The characters will appear on the info screen as asterisks.

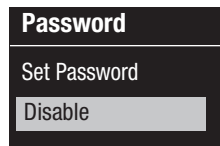

To disable your password, follow Steps 1 through 4 of “Setting the Security Password”, and select “Disable” on the Password menu.

Language Selection

The GRAFIK Eye® QS control unit is capable of operating in the following languages:

- English
- French
- Spanish
- German
- Italian
- Portuguese

To change the language to one of these choices, press the Timeclock button four times, until the “Language” screen is displayed. (Note: Do not put the unit in programming mode.) Use the Master buttons to highlight your preferred language, and press the OK button to select and save.

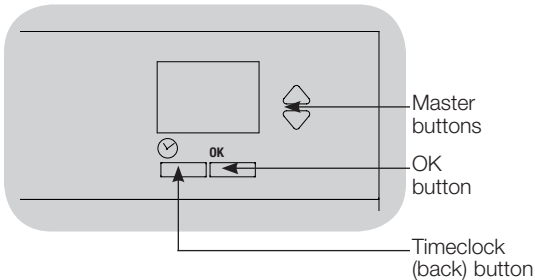

Faceplate Removal

The faceplates may need to be removed to change the color or to write in zone labels. To remove either faceplate, open it fully (flush to the wall), and pull up (for the top faceplate) or down (for the bottom faceplate) to pull the hinges out of their slots.

Replace by sliding the hinges back into their slots.

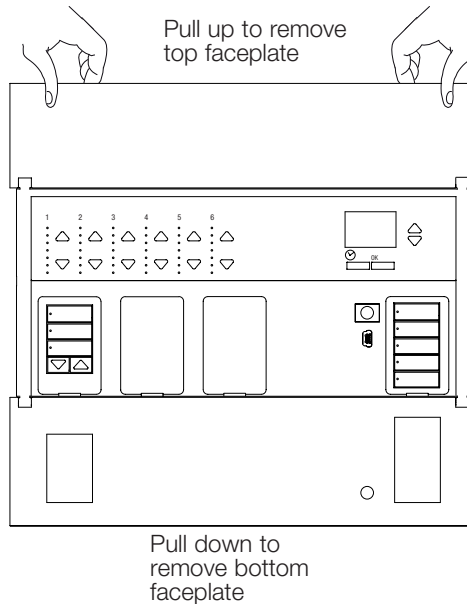

Troubleshooting

Symptom	Possible Causes	Solution
Unit does not power up	Circuit Breaker is off	Switch circuit breaker on
Unit does not control loads	Miswire	Verify wiring to unit and loads
Circuit breaker is tripping	System short circuited	Find and correct shorts
	System overload	Verify zone/unit loading is within ratings (see Zone Setup section)
Zone control does not work	Miswire	Make sure loads are connected to the right zones
Zone control yields incorrect results	Loose or disconnected wire	Connect zone wires to loads
	Burned out lamps	Replace bad lamps
	Incorrect load type selected	Assign the zone to the appropriate load type (see Zone Setup section)
	Dimming limits set incorrectly	Adjust High End/Low End values (see Zone Setup section)
One or more zones are always “full on” and zone intensity is not adjustable	Miswire	Make sure loads are connected to the right zones
Zone control affects more than one zone	Shorted line output	Check wiring; if wiring is correct, call Lutron Technical Support
Faceplate is warm	Normal operation	Solid-state controls dissipate about 2% of the connected load as heat. No action is required
Unit does not allow scene change or zone adjustments	Unit is in wrong save mode	Change to correct save mode
	QS device in system has locked the unit	Check programming and state of QS devices
Cannot program fade time from “Scene Off”	Fade time from “Scene Off” is not programmable; can only program fade time to “Scene Off”	Fade time from “Scene Off” is always 3 seconds
Integral (direct-wired) contact closure input does not work	Miswire	Check wiring on contact closure input
	Input CCI signal is not received	Verify the input device is operating properly
	Unit is in wrong CCI mode and/or type	Change to correct CCI mode and/or type for your application
QS devices on link are not working	Miswire or loose connection on QS link	Verify QS link wiring to all devices
	QS device is not associated	Place the QS device into programming mode, and hold the “Scene 1” button on the GRAFIK Eye® QS control unit to associate the two devices
	QS device programming is incorrect	Verify the functionality and programming on the QS devices
Timeclock events do not occur	Timeclock is disabled	Enable the timeclock
Sunrise or sunset events do not occur at the correct time	Time/date is not set correctly	Set the time/date
	Location is not set correctly	Set the latitude and longitude of the unit’s location
	Holiday schedule is in effect	Normal schedule will resume when the holiday ends

Troubleshooting (continued)

Symptom	Possible Causes	Solution
Device does not respond to infrared controls	IR Receiver is disabled	Enable the IR receiver
	Miswire or loose connection on rear IR terminal	Verify rear IR terminal wiring
Security lockout from programming mode	Security password set incorrectly	Call Lutron Technical Support to reset password

Troubleshooting: Wireless Functions (for wireless enabled units only)

Symptom	Possible Causes	Solution
Cannot associate a wireless device to a unit	Unit does not support wireless functionality	Verify the unit says “GRAFIK Eye® QS Wireless” on the front label.
	Unit in incorrect wireless mode	Change wireless mode to “Enabled”
	Maximum number of devices have been associated with unit	Remove devices or associate with a different unit
	Wireless device is out of range	Verify wireless device is in range: 30 feet (9 m) through standard construction, 60 feet (18 m) line of sight)
Associated wireless devices do not control unit	Wireless device has been unassigned from unit	Reassign wireless device to unit
	Devices are not receiving power	Check wireless device’s battery/power wiring
	Unit in incorrect wireless mode	Change to correct wireless mode (“Ignore Programming” or “Enabled”)
	Multiple devices are associated to the unit with contrasting settings	Verify the settings of wireless devices are consistent
	Wireless device is out of range	Verify wireless device is in range: 9 m through standard construction, 18 m line of sight)
Radio Powr Savr™ daylight sensors not in calibration mode	Follow instructions to calibrate daylight sensors	
Wireless devices operate incorrectly	System is not configured correctly	Make sure wireless device settings are programmed as desired
	Intended settings were not saved	Reprogram wireless device settings
Wireless devices selectively operate	Wireless devices not located correctly	Follow instructions for each device to verify it is located for ideal performance
Info screen often prompts for wireless device association	Unit wireless mode set to “Enabled” and nearby wireless systems are being programmed	Change wireless mode to “Ignore Programming”

Troubleshooting: Window Treatment Functions

Symptom	Possible Causes	Solution
Window treatment EDU (electronic drive unit) will not move	EDU is not powered	Connect power to EDU
	Window treatment fabric is caught on something	Check and unbind window treatment fabric
	EDU is not assigned to a shade button group	Assign the EDU to a shade button group
Shade button group will not control any window treatment	All limits are set to the same height	Verify limit settings
	Communications link is not wired to the EDU	Check and wire the EDU link
	EDU has been unassigned from shade button group	Reassign the EDU to the shade button group
Window treatment EDU does not fully open or fully close	Limits have been set incorrectly	Set limits correctly
	Window treatment fabric is caught on something	Check and unbind window treatment fabric
Window treatment moves in the opposite direction when raise/lower buttons are pushed	Open and close limits have been reversed	Set limits correctly
Shade button group does not operate all the window treatments it is assigned to	EDU has been unassigned from shade button group	Reassign the EDU to the shade button group
	All limits are set to the same height	Verify limit settings
	EDU is not wired correctly	Check and rewire EDU
	Shade button group is not wired correctly	Check and rewire shade button group
Window treatments in a room move on their own	EDUs are assigned to a shade button group in another room	Reassign the EDU to the correct shade button group
Unable to set limits on Sivoia® QS wireless window treatments through the GRAFIK Eye® QS control unit.	Normal operation	Limits must be set manually on the Sivoia® QS wireless EDU (see Sivoia® QS wireless shade installation guide)

Warranty

Lutron Electronics Co., Inc. One Year Limited Warranty

For a period of one year from the date of purchase, and subject to the exclusions and restrictions described below, Lutron warrants each new unit to be free from manufacturing defects. Lutron will, at its option, either repair the defective unit or issue a credit equal to the purchase price of the defective unit to the Customer against the purchase price of comparable replacement part purchased from Lutron. Replacements for the unit provided by Lutron or, at its sole discretion, an approved vendor may be new, used, repaired, reconditioned, and/or made by a different manufacturer.

If the unit is commissioned by Lutron or a Lutron approved third party as part of a Lutron commissioned lighting control system, the term of this warranty will be extended, and any credits against the cost of replacement parts will be prorated, in accordance with the warranty issued with the commissioned system, except that the term of the unit's warranty term will be measured from the date of its commissioning.

EXCLUSIONS AND RESTRICTIONS

This Warranty does not cover, and Lutron and its suppliers are not responsible for:

1. Damage, malfunction or inoperability diagnosed by Lutron or a Lutron approved third party as caused by normal wear and tear, abuse, misuse, incorrect installation, neglect, accident, interference or environmental factors, such as (a) use of incorrect line voltages, fuses or circuit breakers; (b) failure to install, maintain and operate the unit pursuant to the operating instructions provided by Lutron and the applicable provisions of the National Electrical Code and of the Safety Standards of Underwriter's Laboratories; (c) use of incompatible devices or accessories; (d) improper or insufficient ventilation; (e) unauthorized repairs or adjustments; (f) vandalism; or (g) an act of God, such as fire, lightning, flooding, tornado, earthquake, hurricane or other problems beyond Lutron's control.
2. On-site labor costs to diagnose issues with, and to remove, repair, replace, adjust, reinstall and/or reprogram the unit or any of its components.
3. Equipment and parts external to the unit, including those sold or supplied by Lutron (which may be covered by a separate warranty).
4. The cost of repairing or replacing other property that is damaged when the unit does not work properly, even if the damage was caused by the unit.

EXCEPT AS EXPRESSLY PROVIDED IN THIS WARRANTY, THERE ARE NO EXPRESS OR IMPLIED WARRANTIES OF ANY TYPE, INCLUDING ANY IMPLIED WARRANTIES OF FITNESS FOR A PARTICULAR PURPOSE OR MERCHANTABILITY. LUTRON DOES NOT WARRANT THAT THE UNIT WILL OPERATE WITHOUT INTERRUPTION OR BE ERROR FREE.

NO LUTRON AGENT, EMPLOYEE OR REPRESENTATIVE HAS ANY AUTHORITY TO BIND LUTRON TO ANY AFFIRMATION, REPRESENTATION OR WARRANTY CONCERNING THE UNIT. UNLESS AN AFFIRMATION, REPRESENTATION OR WARRANTY MADE BY AN AGENT, EMPLOYEE OR REPRESENTATIVE IS SPECIFICALLY INCLUDED HEREIN, OR IN STANDARD PRINTED MATERIALS PROVIDED BY LUTRON, IT DOES NOT FORM A PART OF THE BASIS OF ANY BARGAIN BETWEEN LUTRON AND CUSTOMER AND WILL NOT IN ANY WAY BE ENFORCEABLE BY CUSTOMER.

IN NO EVENT WILL LUTRON OR ANY OTHER PARTY BE LIABLE FOR EXEMPLARY, CONSEQUENTIAL, INCIDENTAL OR SPECIAL DAMAGES (INCLUDING, BUT NOT LIMITED TO, DAMAGES FOR

LOSS OF PROFITS, CONFIDENTIAL OR OTHER INFORMATION, OR PRIVACY; BUSINESS INTERRUPTION; PERSONAL INJURY; FAILURE TO MEET ANY DUTY, INCLUDING OF GOOD FAITH OR OF REASONABLE CARE; NEGLIGENCE, OR ANY OTHER PECUNIARY OR OTHER LOSS WHATSOEVER), NOR FOR ANY REPAIR WORK UNDERTAKEN WITHOUT LUTRON'S WRITTEN CONSENT ARISING OUT OF OR IN ANY WAY RELATED TO THE INSTALLATION, DEINSTALLATION, USE OF OR INABILITY TO USE THE UNIT OR OTHERWISE UNDER OR IN CONNECTION WITH ANY PROVISION OF THIS WARRANTY, OR ANY AGREEMENT INCORPORATING THIS WARRANTY, EVEN IN THE EVENT OF THE FAULT, TORT (INCLUDING NEGLIGENCE), STRICT LIABILITY, BREACH OF CONTRACT OR BREACH OF WARRANTY OF LUTRON OR ANY SUPPLIER, AND EVEN IF LUTRON OR ANY OTHER PARTY WAS ADVISED OF THE POSSIBILITY OF SUCH DAMAGES.

NOTWITHSTANDING ANY DAMAGES THAT CUSTOMER MIGHT INCUR FOR ANY REASON WHATSOEVER (INCLUDING, WITHOUT LIMITATION, ALL DIRECT DAMAGES AND ALL DAMAGES LISTED ABOVE), THE ENTIRE LIABILITY OF LUTRON AND OF ALL OTHER PARTIES UNDER THIS WARRANTY ON ANY CLAIM FOR DAMAGES ARISING OUT OF OR IN CONNECTION WITH THE MANUFACTURE, SALE, INSTALLATION, DELIVERY, USE, REPAIR, OR REPLACEMENT OF THE UNIT, OR ANY AGREEMENT INCORPORATING THIS WARRANTY, AND CUSTOMER'S SOLE REMEDY FOR THE FOREGOING, WILL BE LIMITED TO THE AMOUNT PAID TO LUTRON BY CUSTOMER FOR THE UNIT. THE FOREGOING LIMITATIONS, EXCLUSIONS AND DISCLAIMERS WILL APPLY TO THE MAXIMUM EXTENT ALLOWED BY APPLICABLE LAW, EVEN IF ANY REMEDY FAILS ITS ESSENTIAL PURPOSE.

TO MAKE A WARRANTY CLAIM

To make a warranty claim, promptly notify Lutron within the warranty period described above by calling the Lutron Technical Support Center at (800) 523-9466. Lutron, in its sole discretion, will determine what action, if any, is required under this warranty. To better enable Lutron to address a warranty claim, have the unit's serial and model numbers available when making the call. If Lutron, in its sole discretion, determines that an on-site visit or other remedial action is necessary, Lutron may send a Lutron Services Co. representative or coordinate the dispatch of a representative from a Lutron approved vendor to Customer's site, and/or coordinate a warranty service call between Customer and a Lutron approved vendor.

This warranty gives you specific legal rights, and you may also have other rights which vary from state to state. Some states do not allow limitations on how long an implied warranty lasts, so the above limitation may not apply to you. Some states do not allow the exclusion or limitation of incidental or consequential damages, so the above limitation or exclusion may not apply to you.

NEC is a registered trademark of the National Fire Protection Association, Quincy, Massachusetts.

Lutron,  Sivoia, Hi-lume, Eco-10, Tu-Wire, Pico, seeTouch, Quantum, and GRAFIK Eye are registered trademarks and Radio Power Savr and Energi Savr Node are trademarks of Lutron Electronics Co., Inc.

© 2012 Lutron Electronics Co., Inc. I

Contact Information

Internet: www.lutron.com
E-mail: product@lutron.com

WORLD HEADQUARTERS USA

Lutron Electronics Co., Inc.
7200 Suter Road, Coopersburg, PA 18036-1299
TEL +1.610.282.3800
FAX +1.610.282.1243
Toll-Free 1.888.LUTRON1
Technical Support 1.800.523.9466

North and South America Technical Hotlines

USA, Canada, Caribbean: 1.800.523.9466
Mexico: +1.888.235.2910
Central/South America: +1.610.282.6701

EUROPEAN HEADQUARTERS

United Kingdom

Lutron EA Ltd.
6 Sovereign Close, London, E1W 3JF United Kingdom
TEL +44.(0)20.7702.0657
FAX +44.(0)20.7480.6899
FREEPHONE (UK) 0800.282.107
Technical support +44.(0)20.7680.4481

ASIAN HEADQUARTERS

Singapore

Lutron GL Ltd.
15 Hoe Chiang Road, #07-03, Tower 15,
Singapore 089316
TEL +65.6220.4666
FAX +65.6220.4333

Asia Technical Hotlines

Northern China: 10.800.712.1536
Southern China: 10.800.120.1536
Hong Kong: 800.901.849
Indonesia: 001.803.011.3994
Japan: +81.3.5575.8411
Macau: 0800.401
Singapore: 800.120.4491
Taiwan: 00.801.137.737
Thailand: 001.800.120.665853
Other countries: +65.6220.4666

