

Triathlon Select Roller Shade Assembly & Installation

Worldwide Headquarters | USA
Lutron Electronics Co., Inc.
7200 Suter Road,
Coopersburg, PA 18036-1299 USA
Customer Assistance: 1.844.LUTRON1
lutron.com/help | support@lutron.com

English

Assembly, Mounting, and Setup Guide for Remote-Controlled Shades. Please read before installing.

⚠ WARNING: Important safety instructions

For safe installation and operation of this product, follow and save these important safety instructions.

- This device is not intended for use by persons (including children) with reduced physical, sensory, or mental capabilities, or lack of experience and knowledge, unless they have been given supervision or instruction concerning use of the device by a person responsible for their safety. Children must be supervised to ensure that they do not play with the device.
- **DO NOT** allow children to play with device controls. Keep remote controls away from children.
- This device is powered by D size, alkaline batteries only; **DO NOT** mix battery types.
- Install new batteries only; **DO NOT** mix new and used batteries.
- **DO NOT** install damaged or modified batteries.
- **DO NOT** install rechargeable batteries.
- Remove depleted batteries promptly and dispose of them responsibly in accordance with local laws and policies. Recycle if possible.
- Wear hand and face protection when removing batteries found to be leaking, and dispose of leaking batteries responsibly in accordance with local laws and policies.
- Remove all batteries from the device:
 - when maintenance is being performed in the vicinity.
 - when the device will be unused or stored for an extended period of time.
- **DO NOT** expose the device or its batteries to extreme temperature.

Important Installation Notes:

- Plan the installation to maintain sufficient clearance between the shade and any other object, including window or door trim, ceilings, corners, hardware, cranks, lock levers, other shades, and drapery.
- This product is battery powered and not suitable for mounting in a pocket or recess as it requires specific installation clearances to allow battery changes without demounting.
- It is the responsibility of the installer to use fasteners of appropriate type and length, such that each shade bracket can support 150 lbs (68 kg), and ensure they are driven securely into a solid structure. Add secure blocking if necessary.

Applicable Model Numbers

– QSERJ

Table of Contents

Shade Assembly	pages 2-11
Shade Programming and Troubleshooting	pages 12-14



1 Prepare to Install

Depending on the shade configuration, you will receive the shade either assembled or unassembled. Type A and Type B1 shades will come mostly pre-assembled; Type B2 will require additional assembly. Shades with five (5) D-cell battery trays require Type A Bracket Kits, and shades with four (4) D-cell battery trays require Type B bracket kits. Use the table below to identify what shade you have received and follow the applicable installation steps.

Type A (one box) - follow steps 3, 4, and 6 - 8

Identifying Features:

Shade: 5 D-Cell battery tray, fully closed ends with protruding Idler axle

Type A Bracket Box: Metal Rails on Left bracket assembly, U-shaped socket on Right bracket assembly

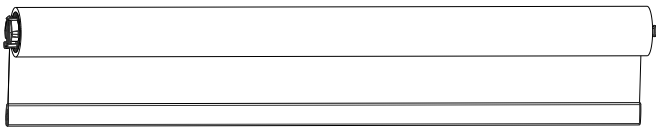

Assembled Shade

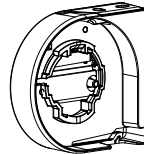

Left Bracket Assembly*

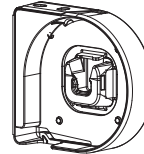

Right Bracket Assembly*

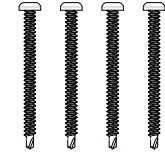

4 - #8 x 2 in T20 Torx Drive screws

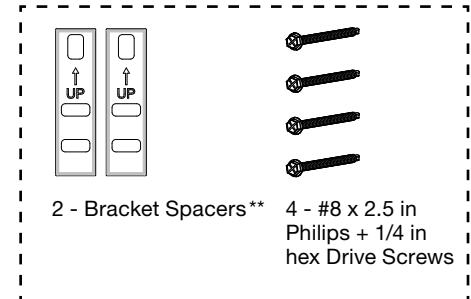

**Spacer kits only included for "Outside, Above Trim" mounting selection when ordered, can be provided upon request

* Bracket assemblies comprise a Shade bracket and Mounting bracket

Type B1 (one box) - follow steps 2 - 4 and 6 - 8

Identifying Features:

Shade: 4 D-Cell battery tray, Fabric roll with single open end

Type B Bracket Box: Plastic features inside Left bracket assembly, single-piece shade idler on Right bracket assembly axle

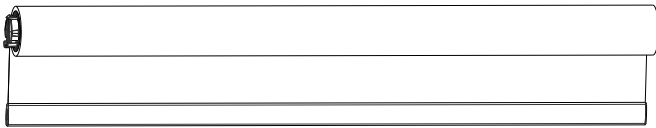

Assembled Shade

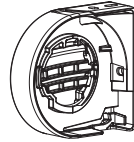

Left Bracket Assembly*

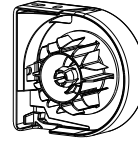

Right Bracket Assembly* and Shade Idler

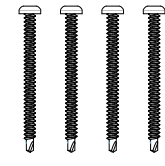

4 - #8 x 2 in T20 Torx Drive screws

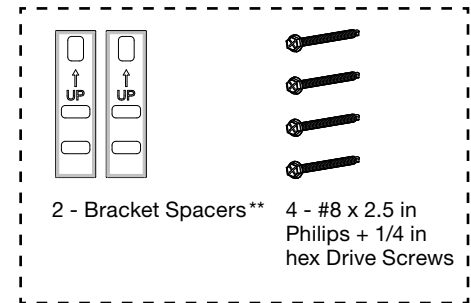

**Spacer kits only included for "Outside, Above Trim" mounting selection when ordered, can be provided upon request

* Bracket assemblies comprise a Shade bracket and Mounting bracket

Type B2 (two boxes) - follow all steps

Identifying Features:

Box 1: Open ended fabric roll, separated Hembar

Box 2: Type B Bracket Box, standalone shade drive with 4 D-Cell battery tray, drive installation tool, and hembar endcaps

Components in Box #1

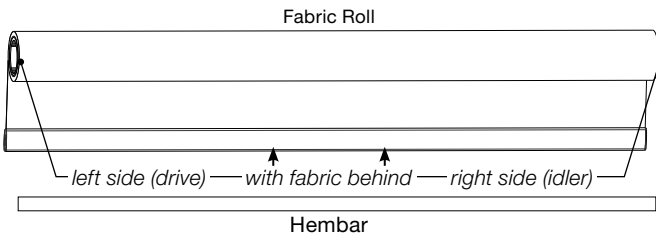

Components in Box #2

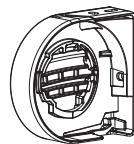

Left Bracket Assembly*

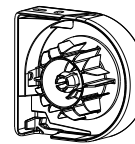

Right Bracket Assembly* and Shade Idler

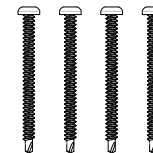

4 - #8 x 2 in T20 Torx Drive screws

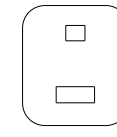

Drive Installation Tool

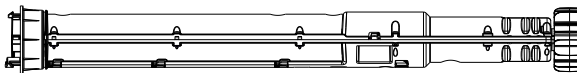

Shade Drive



2 - Hembar Endcaps

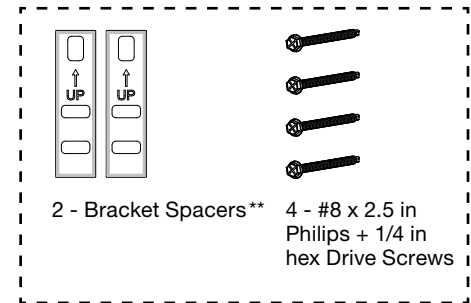

** Provided separately upon request

* Bracket assemblies comprise a Shade bracket and Mounting bracket

1 Prepare to Install *(continued)*

Other Items You Will Need

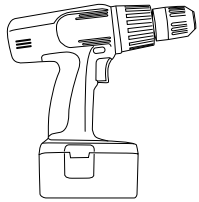

Power Drill/Driver



Pencil

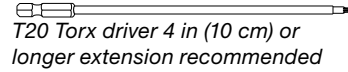

T20 Torx driver 4 in (10 cm) or longer extension recommended

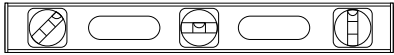

Level



Tape Measure

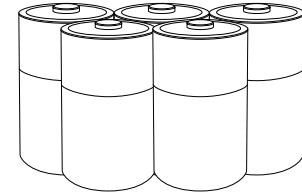

D-Size Alkaline Batteries available separately
Use Lutron Recommended Battery brand.
Please see [Lutron App Note #561 \(P/N 048561\)](#) at lutron.com for more information.



1/8 in (#31) drill bit for screw pilot holes into structure (optional)

Installation Specific requirements:

Outside Mount Above Trim: - either a Phillips #2 or 1/4 in hex drive with 4 in (10 cm) or longer extension for provided screws

Outside Mount Above Trim

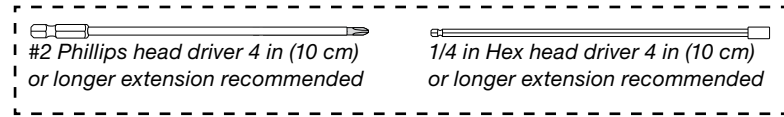

Jamb Mounting - 3/16 in drill bit to drill out bracket, appropriate 2 in (5 cm) #8 flat head screws (provided by others) and relevant drive

Jamb Mount

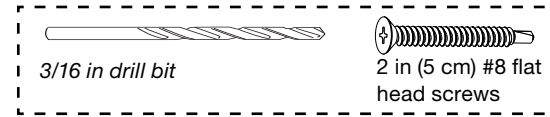

2 Install the Shade Idler

Type A - Skip to Step 3

Type B1 and B2

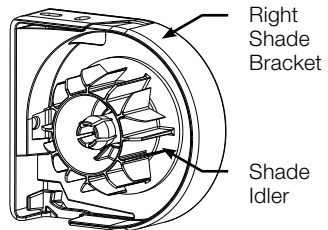

Right Shade Bracket

Shade Idler

a. Locate the shade idler packaged on its axle on the right shade bracket.

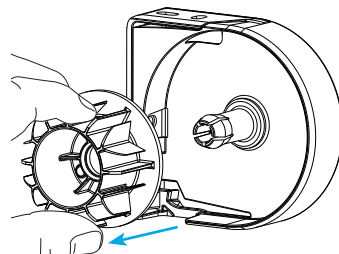

b. Detach the shade idler from the bracket by pulling it straight off the axle.

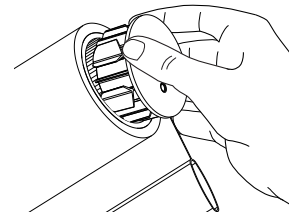

c. Insert the shade idler into the right end of the shade tube with the fabric hanging behind the tube as shown.

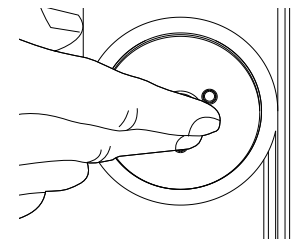

d. Press the shade idler into the shade tube until the flat side of the idler is flush with the end of the tube.

3 Prepare Brackets for Mounting

Type A, B1, and B2

Right Bracket Assembly

Type A

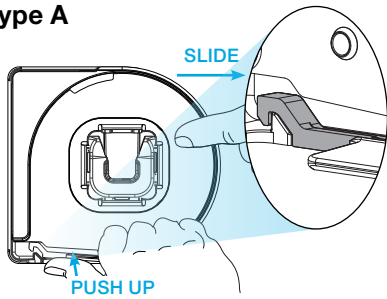

- a. Locate the Right Bracket Assembly and push up on the release tab on the right shade bracket as shown.

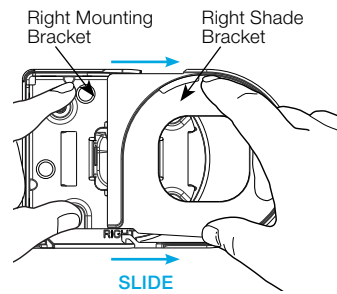

- b. Separate the right shade bracket by sliding it away from the mounting bracket. Set aside the right shade bracket for Step 6.

Left Bracket Assembly

Type A

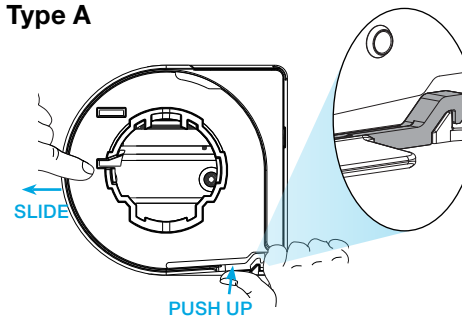

- c. Push up on the release tab on the left shade bracket as shown and slide the shade bracket out.

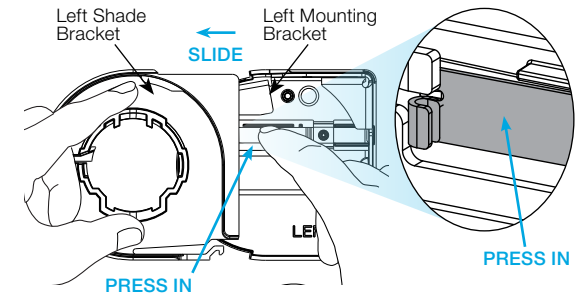

- d. Slide the left shade bracket out and separate it from the left mounting bracket by pressing the release tab as shown and separate the two pieces.

Type B1 and B2

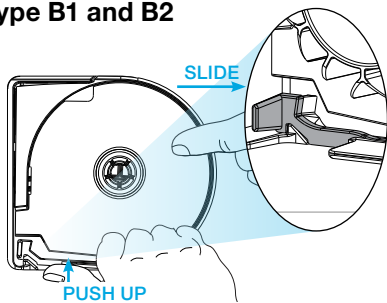

- a. Locate the Right Bracket Assembly and push up on the release tab on the right shade bracket as shown.

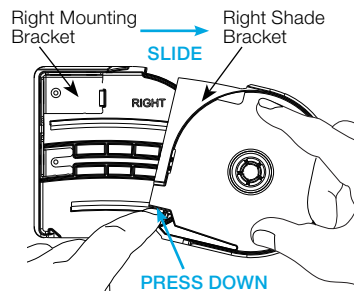

- b. Separate the right shade bracket by pressing down on the release tab and sliding it away from the mounting bracket. Set aside the right shade bracket for Step 6.

Type B1 and B2

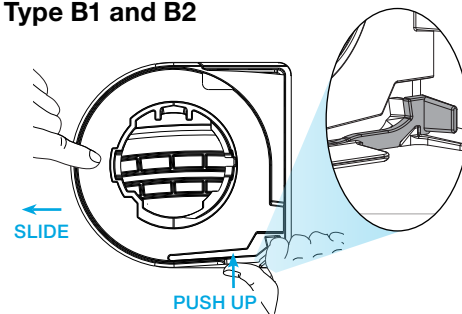

- c. Push up on the release tab on the left shade bracket as shown and slide the shade bracket out.

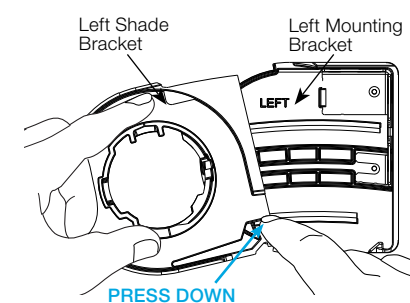

- d. Slide the left shade bracket out and separate it from the left mounting bracket by pressing the release tab as shown and separate the two pieces.

4 Attach the Mounting Brackets to the Mounting Surface

Inside Mount

Type A, B1, and B2

CAUTION: The shade system must be mounted to blocking or other suitable structural material. It is the responsibility of the installer to choose and install fasteners that are appropriate for the mounting surface such that each shade bracket can support 150 lbs (68 kg). Install the mounting brackets using the provided screws or other appropriate fasteners.

Type A

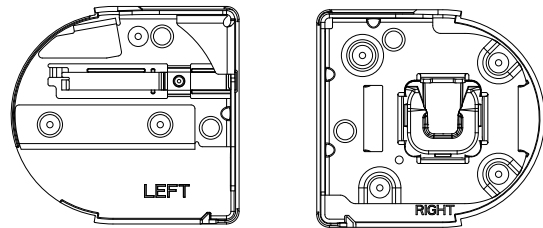

a. Using the System Mounting Options table to the right, take the Left and Right Mounting Brackets and position them on the mounting surface. Mark the hole locations, and use a level to make sure the marks are aligned.

Type B1 and B2

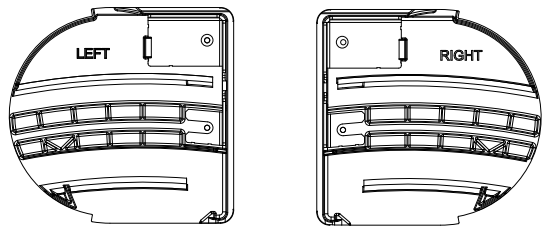

a. Using the System Mounting Options table to the right, take the Left and Right Mounting Brackets and position them on the mounting surface. Mark the hole locations, and use a level to make sure the marks are aligned.

System Mounting Options - Inside Mount

Inside Mount

b. Mark location of screws on the jamb.

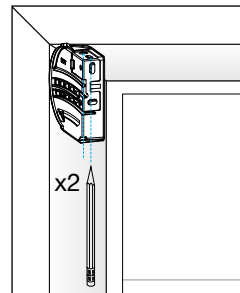

c. Pre-drill pilot holes if appropriate, and drive the screw into the blocking.

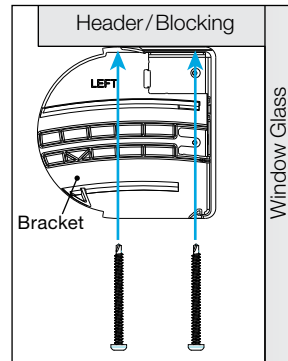

The window jamb must be at least 3.75 in (95 mm) deep for Type A, or 3.5 in (89 mm) deep for Type B, to fully recess the shade.

Screws are driven through the top of the bracket into blocking or other structure as shown.

Inside Jamb Mount

b. Drill out the jamb mounting holes.

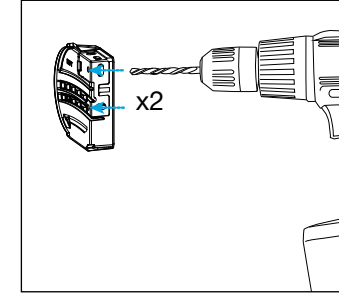

c. Mark location of screws on the jamb.

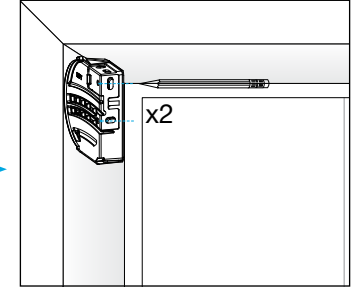

d. Pre-drill pilot holes if appropriate, and drive the screw into the blocking.

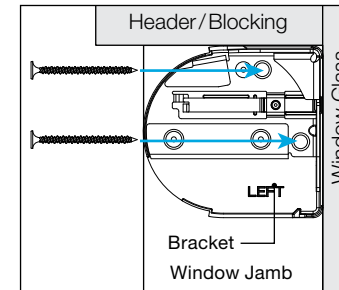

Type A Bracket

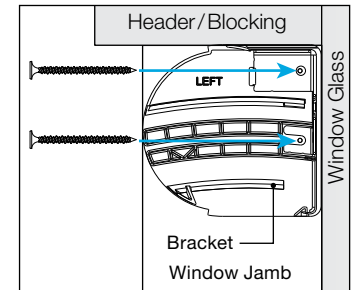

Type B Bracket

NOTE: Type A requires #8 Flat Head screws (not provided) for jamb mounting. Locate the intended jamb mount screw locations on your brackets. Using the 3/16 in drill bit, drill out the jamb mounting hole on your brackets.

Place Bracket in intended location and drive screws through drilled holes into structure.

NOTE: Clearance of 3.75 in (95 mm) for Type A or 3.5 in (89 mm) for Type B is required in front of the brackets for final installation of the shade.

4 Attach the Mounting Brackets to the Mounting Surface *(continued)*

Outside Mount

Type A, B1, and B2

CAUTION: The shade system must be mounted to blocking or other suitable structural material. It is the responsibility of the installer to choose and install fasteners that are appropriate for the mounting surface such that each shade bracket can support 150 lbs (68 kg). Install the mounting brackets using the provided screws or other appropriate fasteners.

Type A

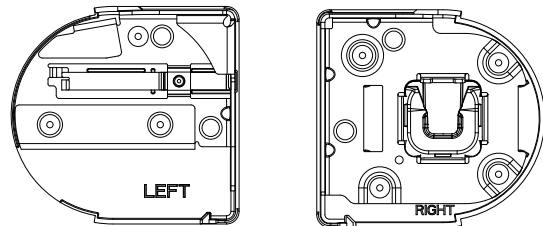

a. Using the System Mounting Options table to the right, take the Left and Right Mounting Brackets and position them on the mounting surface. Mark the hole locations, and use a level to make sure the marks are aligned.

Type B1 and B2

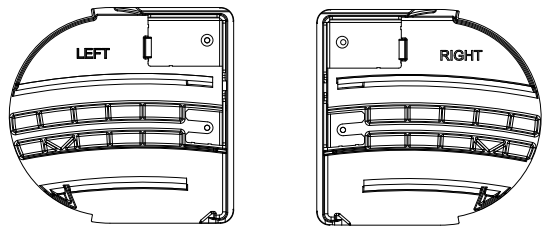

a. Using the System Mounting Options table to the right, take the Left and Right Mounting Brackets and position them on the mounting surface. Mark the hole locations, and use a level to make sure the marks are aligned.

System Mounting Options - Outside Mount

Outside Mount On Trim

b. Mark location of screws on the trim.

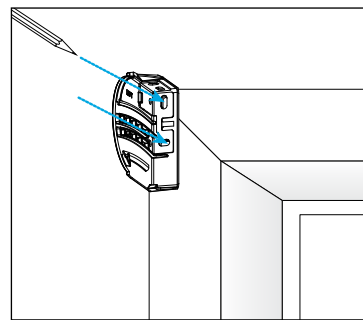

c. Pre-drill pilot holes if appropriate, and drive the screw into the blocking.

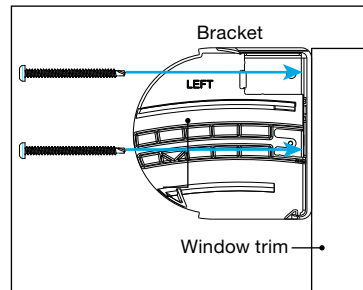

If the window trim is angled, install an angled spacer (not provided) behind each bracket. Pre-drill holes through the spacer if necessary.

Outside Mount Above Trim

b. Mark location of screws on the wall.

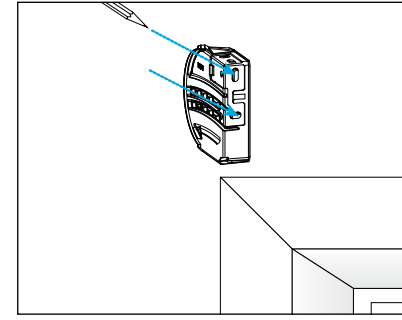

c. Attach the spacer to the back of the bracket.

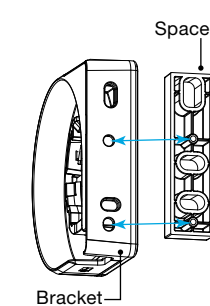

d. Pre-drill pilot holes if appropriate, and drive the screw into the blocking.

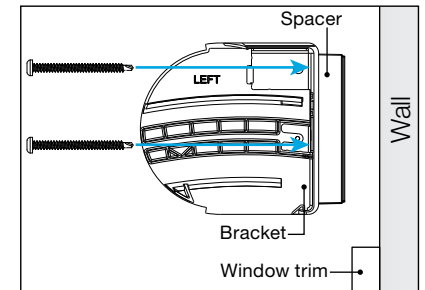

If the window trim protrudes, align and attach the spacer to the back of the bracket. If spacers are required, a set may be requested from Lutron Customer Service. Spacers provide clearance for Trim up to 1/2 in (12.7 mm) in thickness and cannot be stacked. If additional clearance is required, other shim, spacer, or blocking must be used with the appropriate fasteners.

NOTE: Clearance of 3.75 in (95 mm) for Type A or 3.5 in (89 mm) for Type B is required in front of the brackets for final installation of the shade.

5 Install the Shade Drive

Type A and B1 - Skip to Step 6

Type B2

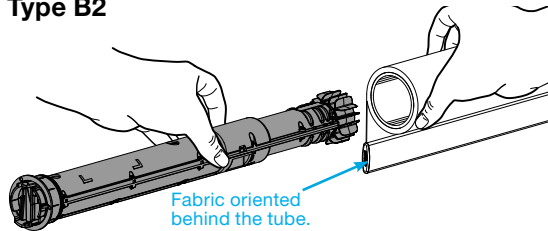

- a.** Insert the shade drive halfway into the left end of the shade tube with the fabric oriented behind the tube, as shown.

Note: Before installing the shade drive, inspect the inside of the fabric tube for damage and clear out any debris.

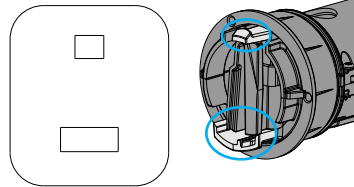

- b.** Notice that the cutout shape of the drive installation tool matches the features on the end of the shade drive.

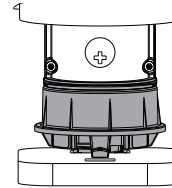

- c.** Align the cutout and fit the tool over the end of the shade drive as shown.

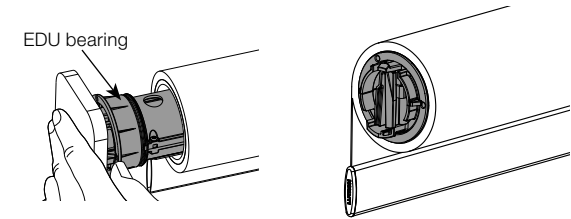

- d.** Use the drive installation tool to push the shade drive the rest of the way into the shade tube until the EDU bearing is flush with the end of the tube.

Note: Fully seating the drive into the tube may require some force. **Be careful to not damage fabric during insertion.**

6 Attach the Shade Brackets

Type A

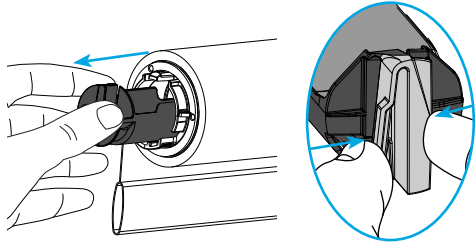

- a.** Remove the battery tray from the shade drive. Pinch battery tray release and pull the tray all the way out of the shade and set it aside.

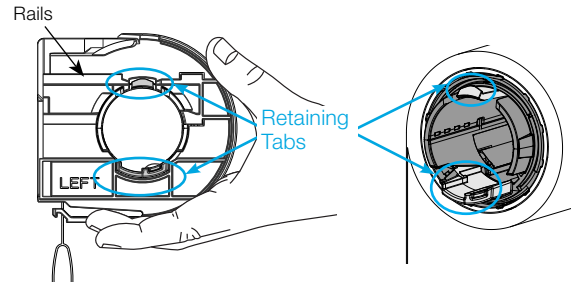

- b.** Position the left shade bracket, with the rails facing away from the assembled shade as shown, and press it onto the shade drive, engaging the retaining tabs at the top and bottom of the drive.

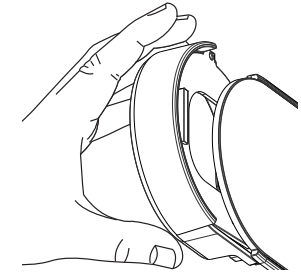

- c.** Replace the right shade bracket in the right mounting bracket. *(Reverse of step 3a.)*

Type B1 and B2

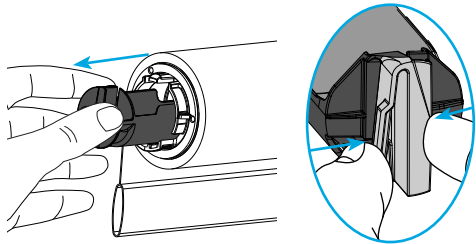

- a.** Remove the battery tray from the shade drive. Pinch battery tray release and pull the tray all the way out of the shade and set it aside.

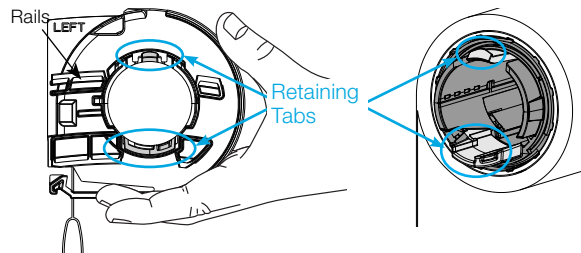

- b.** Position the left shade bracket, with the rails facing away from the assembled shade as shown, and press it onto the shade drive, engaging the retaining tabs at the top and bottom of the drive.

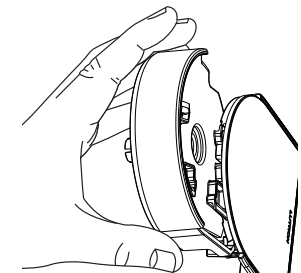

- c.** Replace the right shade bracket in the right mounting bracket. *(Reverse of step 3a.)*

7 Install the Batteries

Type A

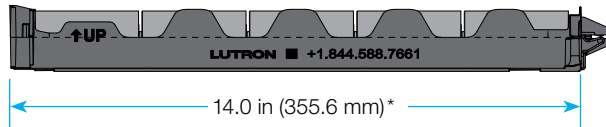

Type B1 and B2

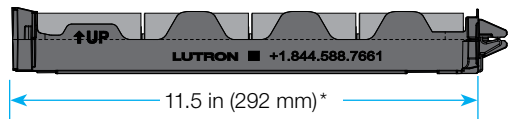

- a. Load fresh D-cell alkaline batteries into the battery tray removed in Step 6a.
- b. Orient the loaded battery tray such that UP arrow points towards the ceiling.

* Clearance required to nearest wall or other obstruction to allow full battery tray access without removing shade.

NOTE: If there is enough room when mounted, the battery tray may be installed after hanging the shade in step 8.

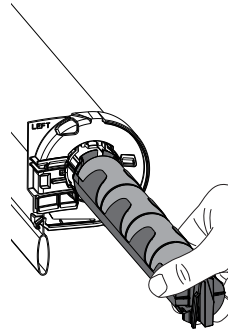

- c. Insert the battery tray into the shade drive, as shown, with the pointed end going into the drive opening, and the open face of the tray (where the batteries are visible) facing away from the shade button.

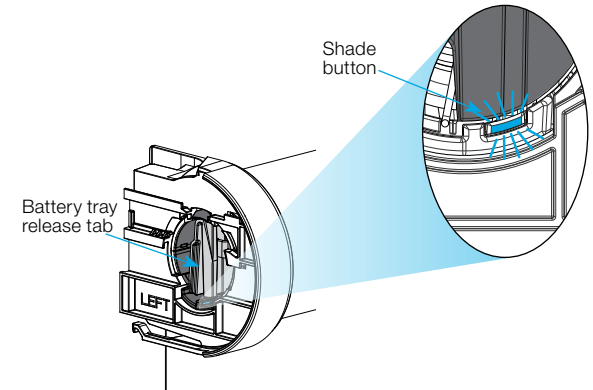

- d. Slide the tray in until fully seated. Pull back without depressing the release to ensure latch is secured. The shade will power up, indicated by the shade button flashing RED/GREEN.

NOTE: The Shade may power up before the tray is fully seated. Continue pressing firmly to securely latch.

8 Hang the Shade in the Brackets

Type A

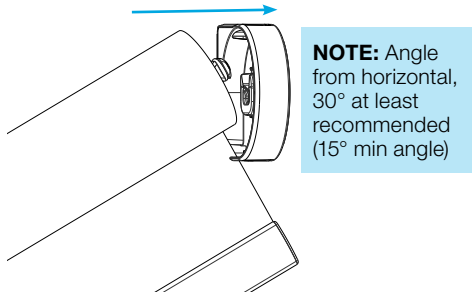

NOTE: Angle from horizontal, 30° at least recommended (15° min angle)

- a. With the Assembled Shade angled as noted, press the axle into the top of the socket of the Right Bracket Assembly and allow the shade to seat into the pocket. To help seat, while the shade is angled, lightly pull down on the end of the shade until it is fully caught by the socket. When aligned and leveled, the shade should be centered in the bracket.

Type B1 and B2

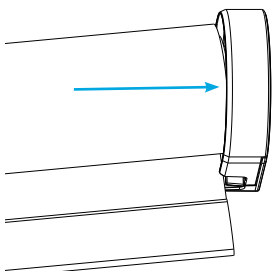

- a. Engage the right end of the shade by fitting the shade idler over the idler axle on the right shade bracket.

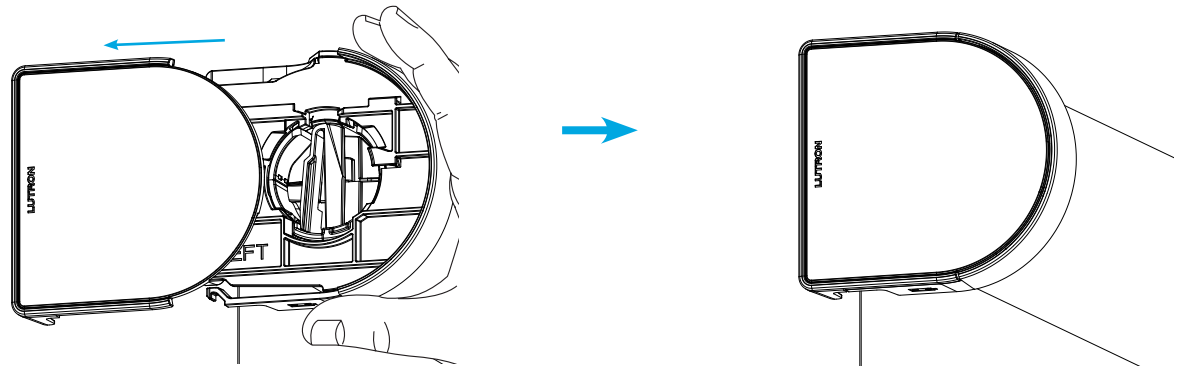

- b. Engage the left end of the shade by aligning the rails and sliding the left shade bracket into the left mounting bracket aligning the rails and sliding. (Reverse of step 3c.)

NOTE: If the battery tray was not inserted in step 7, insert the battery tray before fully closing the left end of the shade.

9 Insert the Hembar

Type A and B1 - Skip this step

Type B2

a. Slide the provided hembar into the hembar pocket of the shade.

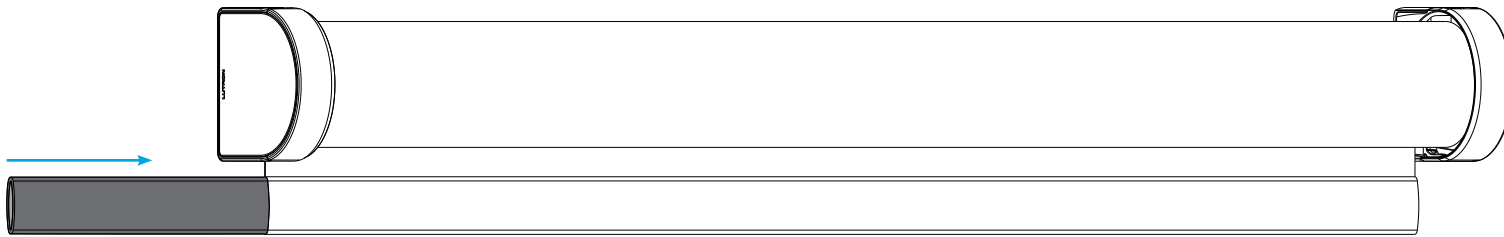

b. Insert the hembar endcaps on either side of the hembar.

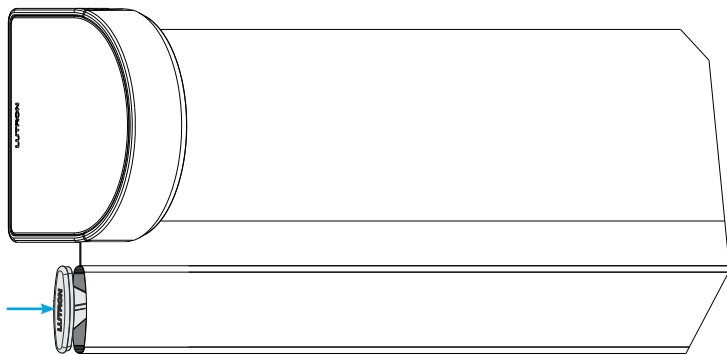

10 Setup and Programming

Type A, B1, and B2

10.1 Determine Control Intent

The shade features a single LED-equipped control button (the 'Shade Button'), located on the Electronic Drive Unit (EDU). The shade button is used to activate and indicate various steps while assigning and programming the shade for compatible handheld or system-based remote control.

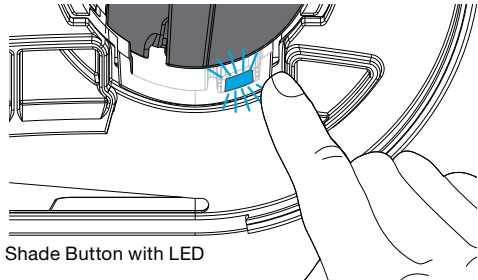

- a. If a Caséta smart hub is installed, use the Lutron App to program and control the shade.
- b. If the shade is to be controlled by a Lutron System, follow the instructions provided with the system to add, program, and control the shade
- c. For non-system applications, follow the steps in section 10.2 and following to assign a Pico remote control. Repeat the sequence for each additional shade or assignment, if applicable.

NOTE: When changing from one type of control assignment to another, any pre-existing assignment must be removed by restoring the shade's factory default settings. Refer to **Restoring Factory Default Settings** in Step 12.

10.2 Putting Shade into Service Position

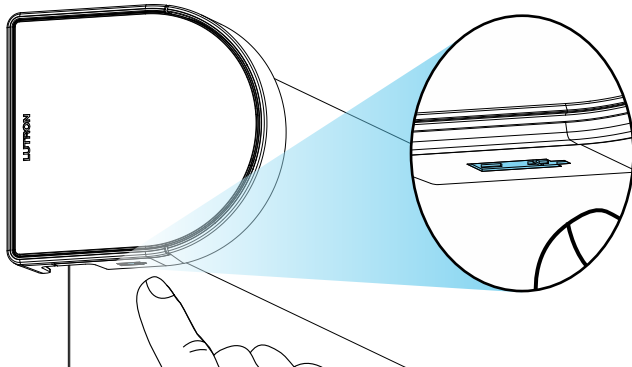

- a. Push up on the release tab on the bottom of the left shade bracket (same as in 3c).

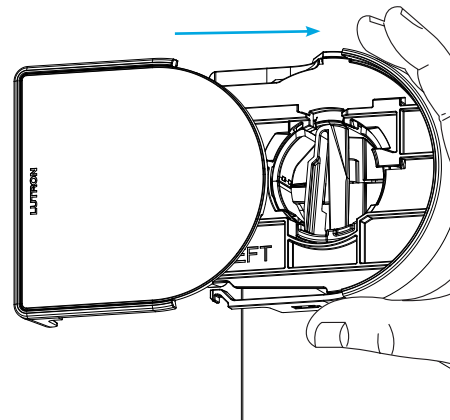

- b. While holding the release tab, slide the bracket forward to expose the battery tray and control button.

CLOSE QUARTERS INSTALLATION:

If you do not have enough room to fully remove the battery tray due to a nearby wall or other obstruction, you will need to remove the shade to change the batteries.

To remove the shade, follow Step 3 to separate the Left Bracket Assembly, and then perform Step 8 in reverse to remove the shade Idler from the mounted bracket.

10 Setup and Programming (continued)

Type A, B1, and B2

10.3 Assign a Pico Wireless Control

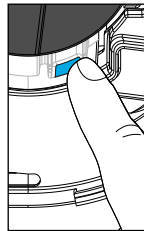
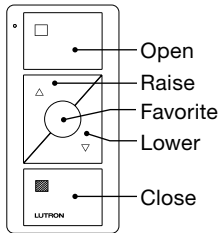

a. Tap the Shade button

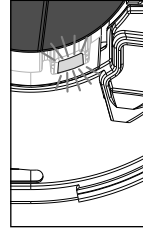

b. The Shade Button lights solid green

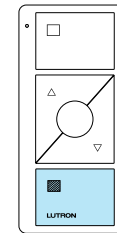

c. Press and hold the Close button for about 10 seconds

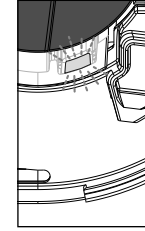

d. Hold the Close Button until the Shade Button flashes green and turns off; assignment is complete

10.4 Adjust Upper and Lower Limits (Optional)

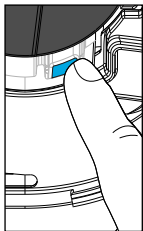

a. Tap the Shade button

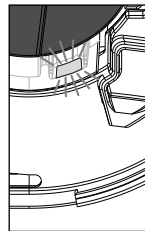

b. The Shade Button lights solid green

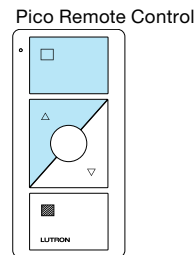

c. Press and hold the Open and Raise buttons simultaneously for about 10 seconds

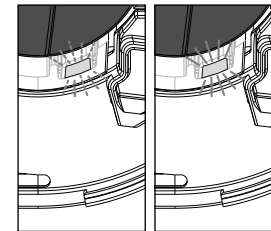

d. The Shade Button flashes green, then stays lit; release all buttons

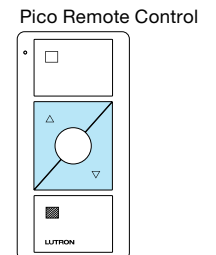

e. Use the Raise and Lower buttons to position the shade as desired

Pico Remote Control

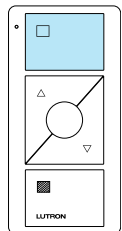

f. SET THE UPPER LIMIT

With the shade at the desired open position, press and hold the Open button for about 10 seconds

OR

Pico Remote Control

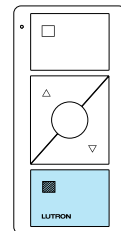

SET THE LOWER LIMIT

With the shade at the desired closed position, press and hold the Close button for about 10 seconds

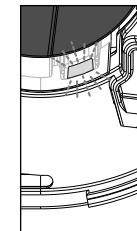

g. Hold the Pico Remote Button until the Shade Button flashes green and turns off; adjustment is complete

10 Setup and Programming (continued)

10.5 Set a Favorite Shade Position (Optional)

Pico Remote Control

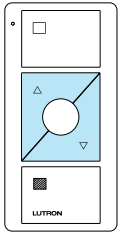

a. Use the Raise/Lower buttons to move the shade to the desired position.

Pico Remote Control

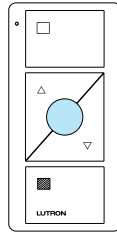

b. Press and hold the Favorite button for 6 seconds.

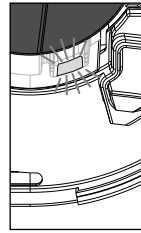

c. Hold the Favorite Button until the shade button flashes green and turns off; the Favorite position is saved

11 Troubleshooting

Problem	Solution
The shade does not power up when batteries are inserted	<ul style="list-style-type: none"> • Verify all batteries are new and of the correct type • Remove all batteries and reinstall, ensuring they are oriented correctly and that the battery tray is fully seated in the drive
The shade does not respond to remote control	<ul style="list-style-type: none"> • Ensure the remote control is within the product's RF range; 30 ft (9 m) • If a system is installed, ensure the remote control is assigned in the app and the shade batteries are adequately charged
Shade motion is sluggish and/or the shade button LED is solid RED during motion	<ul style="list-style-type: none"> • The batteries are low; remove all batteries and replace with new ones, ensuring they are oriented correctly
The shade does not respond and the shade button LED is solid RED	<ul style="list-style-type: none"> • The batteries are too low for shade motion; remove all batteries and replace with new ones, ensuring they are oriented correctly
Shade fabric shifts left or right as it is being rolled into the tube (telescoping fabric).	<ul style="list-style-type: none"> • See Application Note # 14 at lutron.com

12 Restoring Factory Default Settings

Tap the shade button quickly three times, and hold the shade button after the third tap until the shade button LED flashes GREEN rapidly. Immediately tap the shade button quickly three more times, until the shade button LED flashes GREEN rapidly, then flashes RED/GREEN three times, and turns off.

For complete warranty information, refer to: lutron.com/TechnicalDocumentLibrary/Window Systems Warranty.pdf

The Lutron logo, Lutron, Caseta, Pico, and Triathlon are trademarks or registered trademarks of Lutron Electronics Co., Inc. in the US and/or other countries. All other product names, logos, and brands are property of their respective owners.