

Rania® Wiring Solutions For Home Applications

It is possible to wire both the Single and the Dual *Rania* Dimmer in many different configurations. The following pages will show some of the most common situations you may come across in your home and how your *Rania* Dimmers should be wired for optimum performance and reliability.

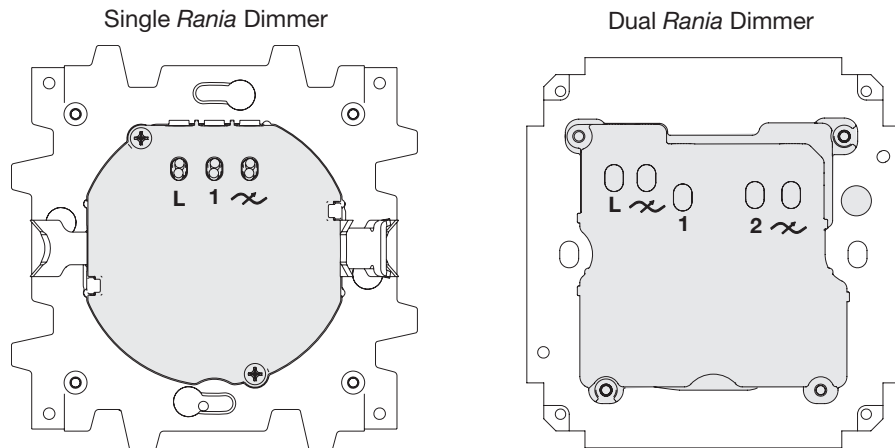

Installing Single *Rania* Dimmers:

Single Dimmer(s) with Accessories

One 2-Way Circuit (A Single Dimmer with a Single Accessory: A or B).....	2
One 3-Way Circuit (A Single Dimmer with two Single Accessories: C , D or E)	3
Two 2-Way Circuits (Two Single Dimmers with one Dual Accessory: F or G).....	4

Single Dimmer(s) with Switches:

One 2-Way Circuit (A Single Dimmer with a Single Switch: H or I).....	5
One 3-Way Circuit (A Single Dimmer with two Single Switches: J or K)	6
Two 2-Way Circuits (Two Dimmers with one Dual Switch: L)	6

Installing Dual *Rania* Dimmers:

Dual Dimmer with Accessories

Two 2-Way Circuits (A Dual Dimmer with a Dual Accessory: M or N).....	7
Two 3-Way Circuits (A Dual Dimmer with two Dual Accessories: O , P or Q)	8
Two 2-Way Circuits (A Dual Dimmer with two Single Accessories: R or S).....	9

Dual Dimmer with Switches:

Two 2-Way Circuits (A Dual Dimmer with a Dual Switch: T or U).....	10
Two 3-Way Circuits (A Dual Dimmer with two Dual Switches: V)	11

Changing *Rania* Settings

Dimmer Operation (Applications with 2-Way Switches).....	11
--	----

A A Single Dimmer With a Single Accessory (5-Wire Location)

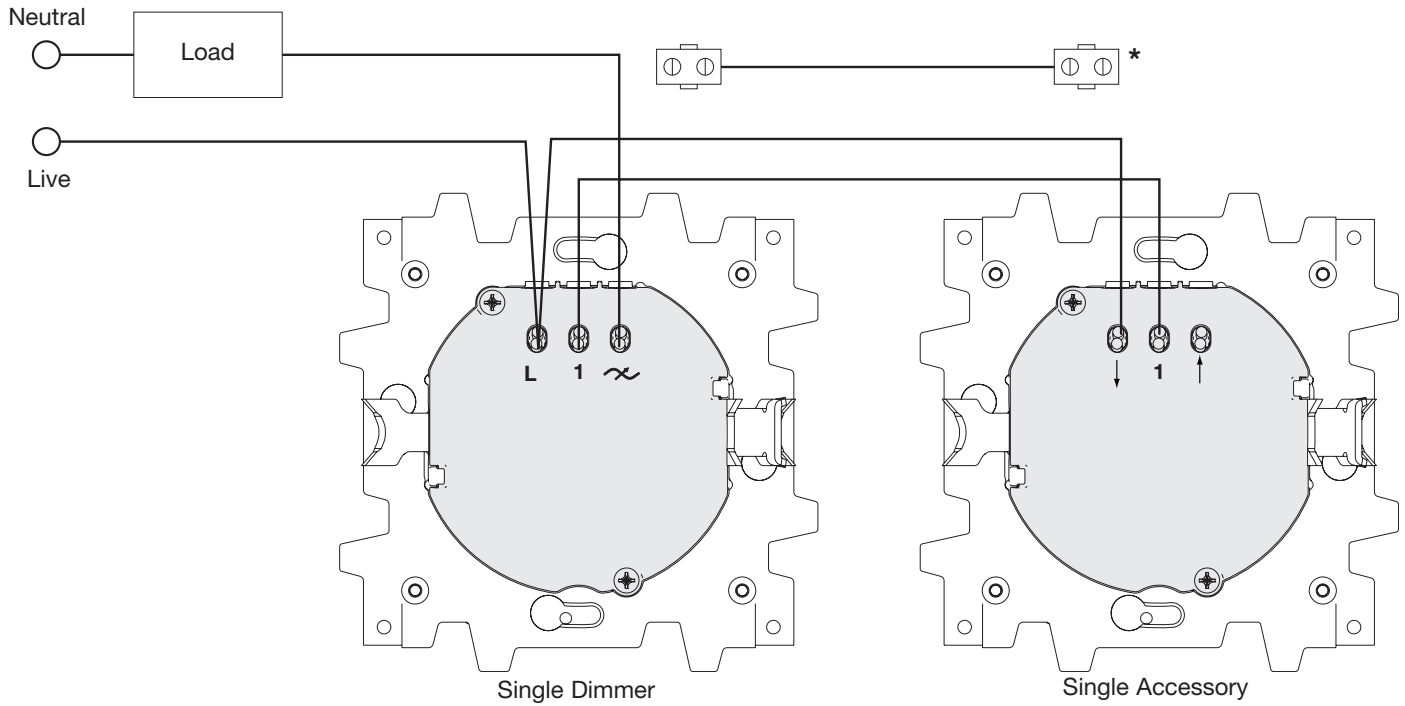

* Note: Follow national and local codes to terminate the wire.

B A Single Dimmer With a Single Accessory (3-Wire Location)

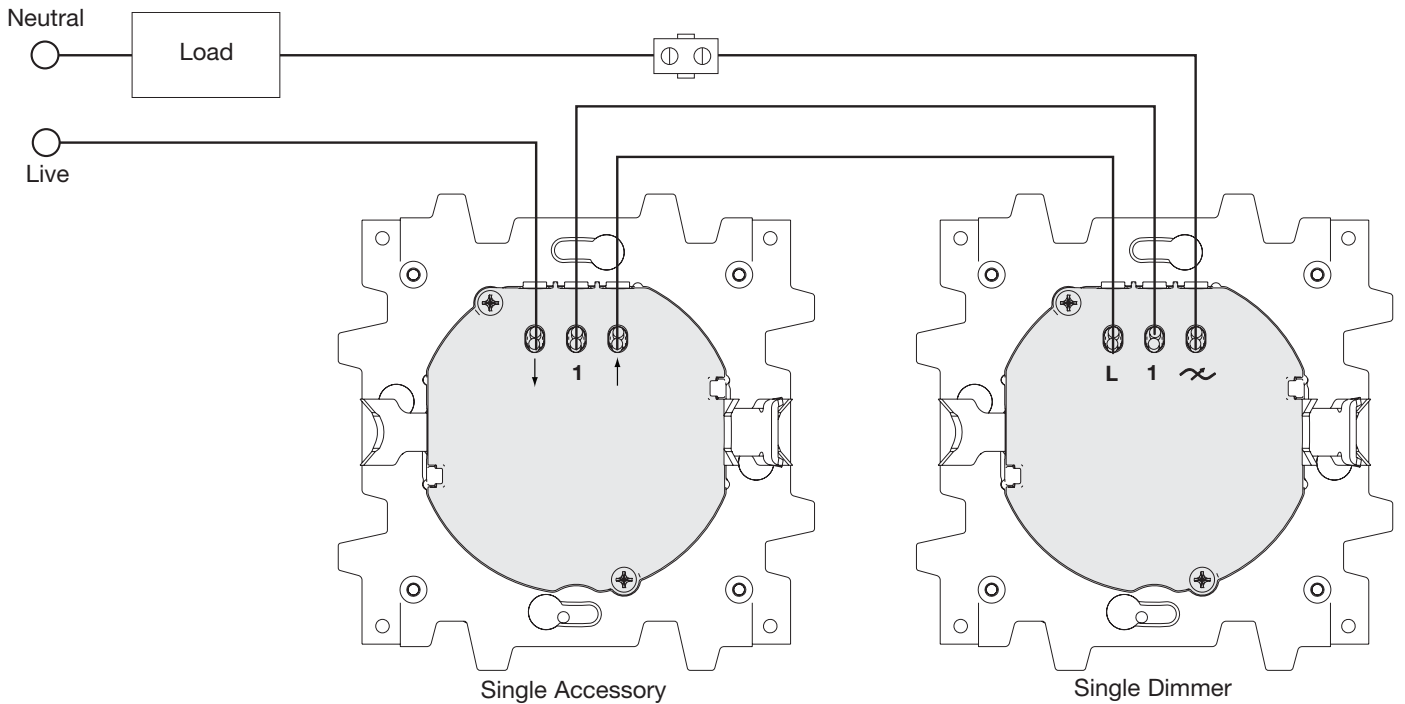

C A Single Dimmer With Two Single Accessories (5-Wire Location)

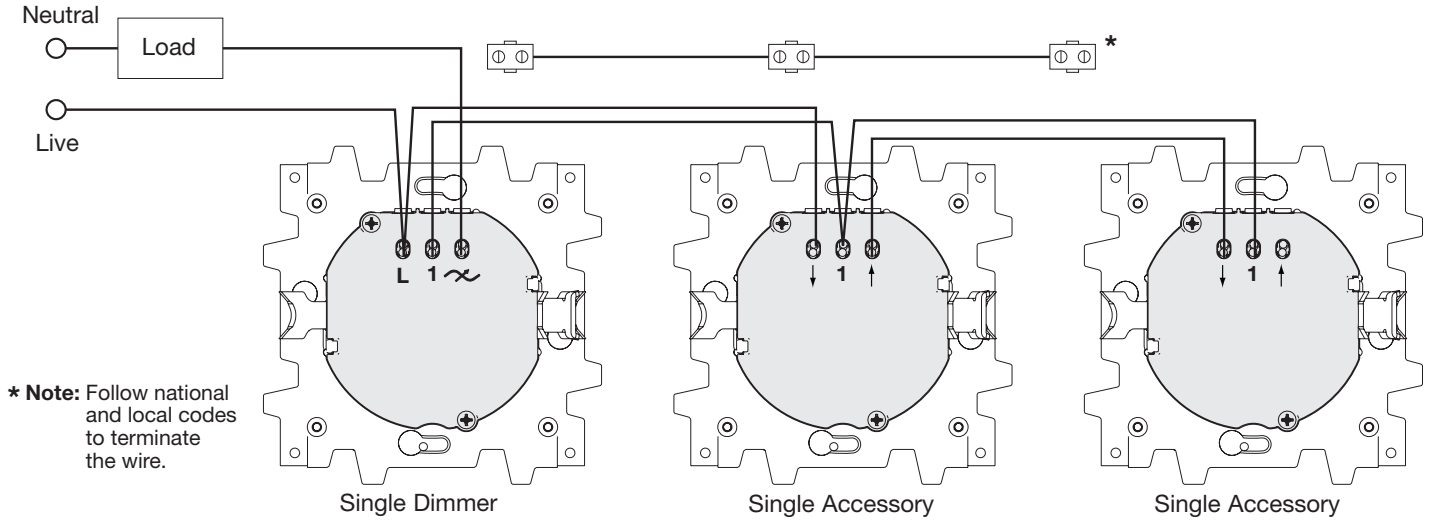

D A Single Dimmer With Two Single Accessories (6-Wire Location)

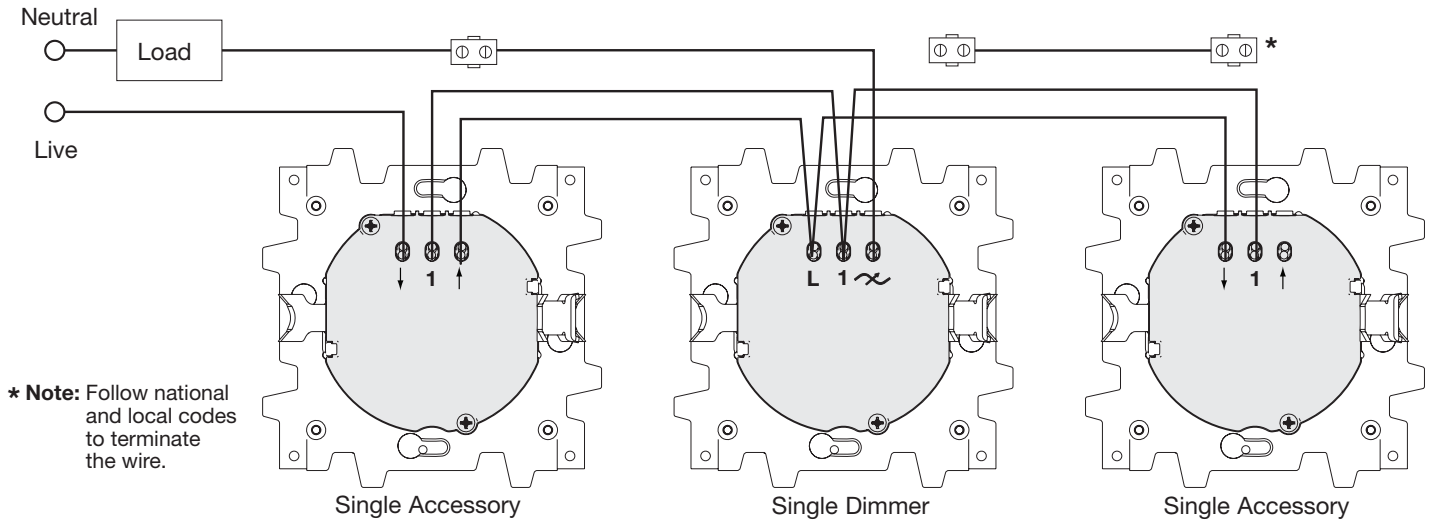

E A Single Dimmer With Two Single Accessories (3-Wire Location)

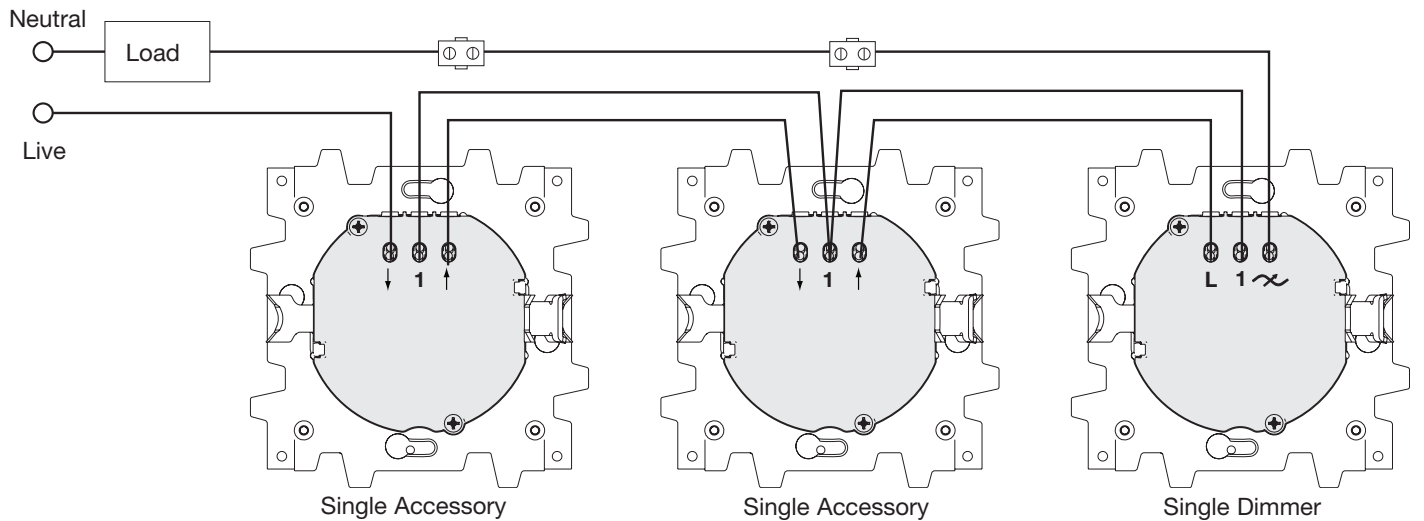

F Two Single Dimmers With One Dual Accessory (3-Wire Location)

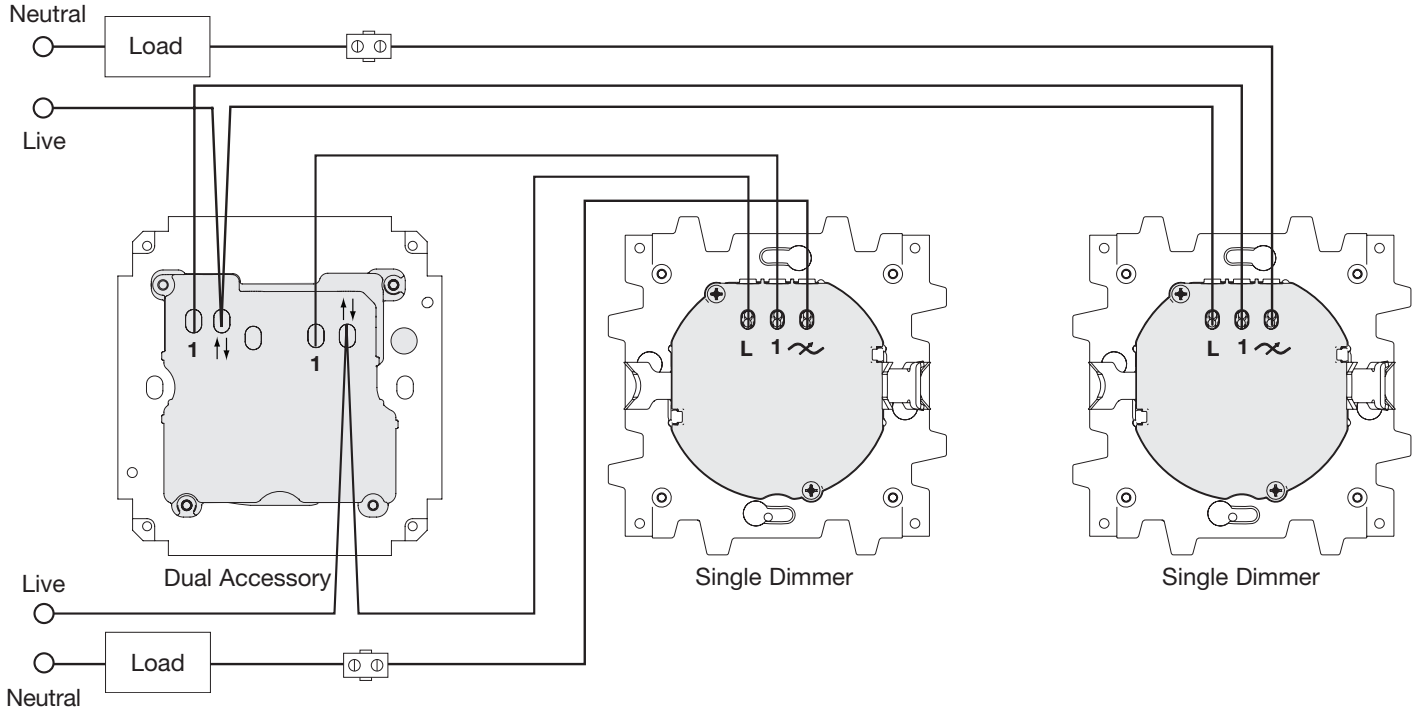

G Two Single Dimmers With One Dual Accessory (5-Wire Location)

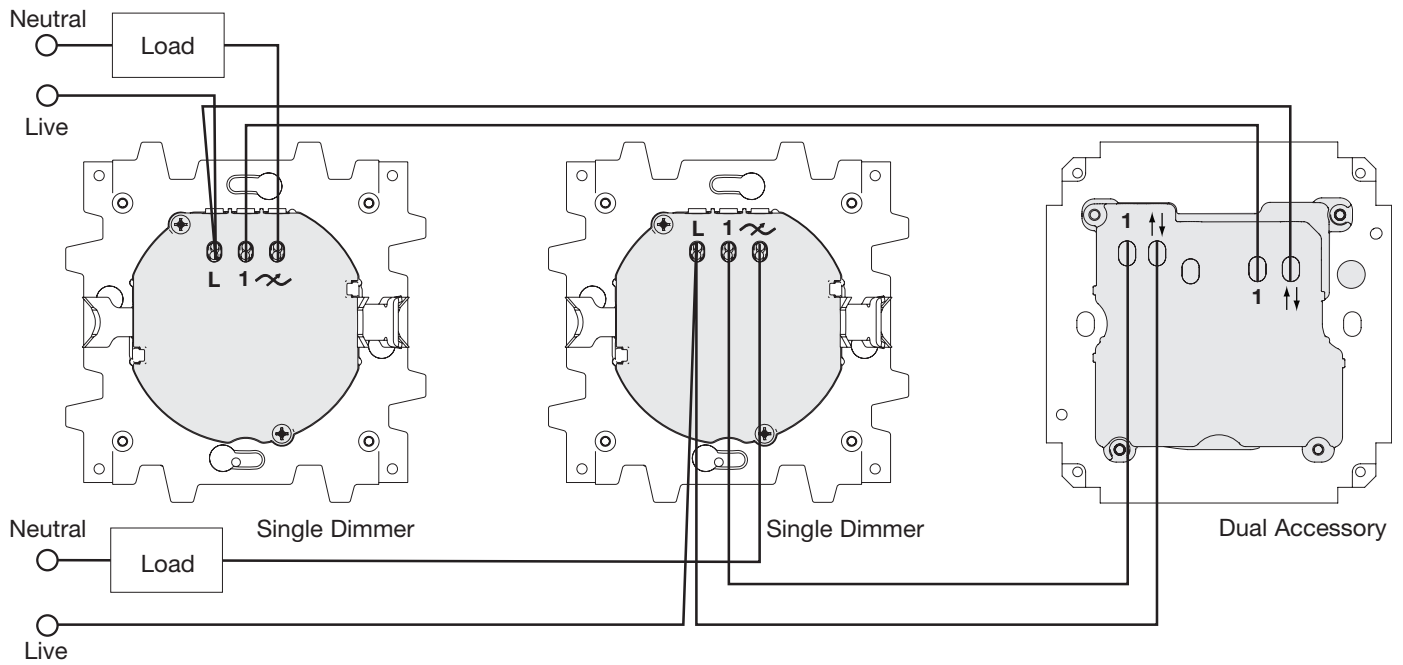

H A Single Dimmer With a Single Switch (5-Wire Location)

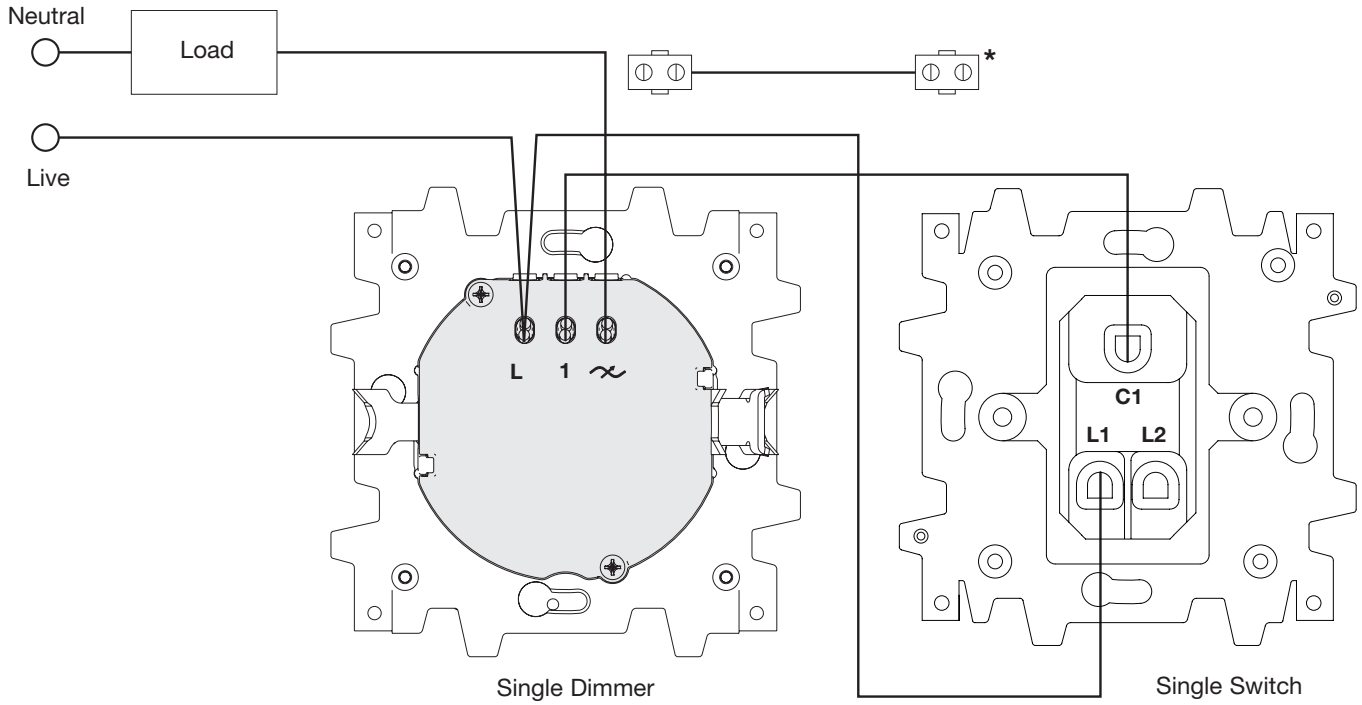

* **Note:** Follow national and local codes to terminate the wire.

Note: Additional programming is required.

I A Single Dimmer With a Single Switch (3-Wire Location)

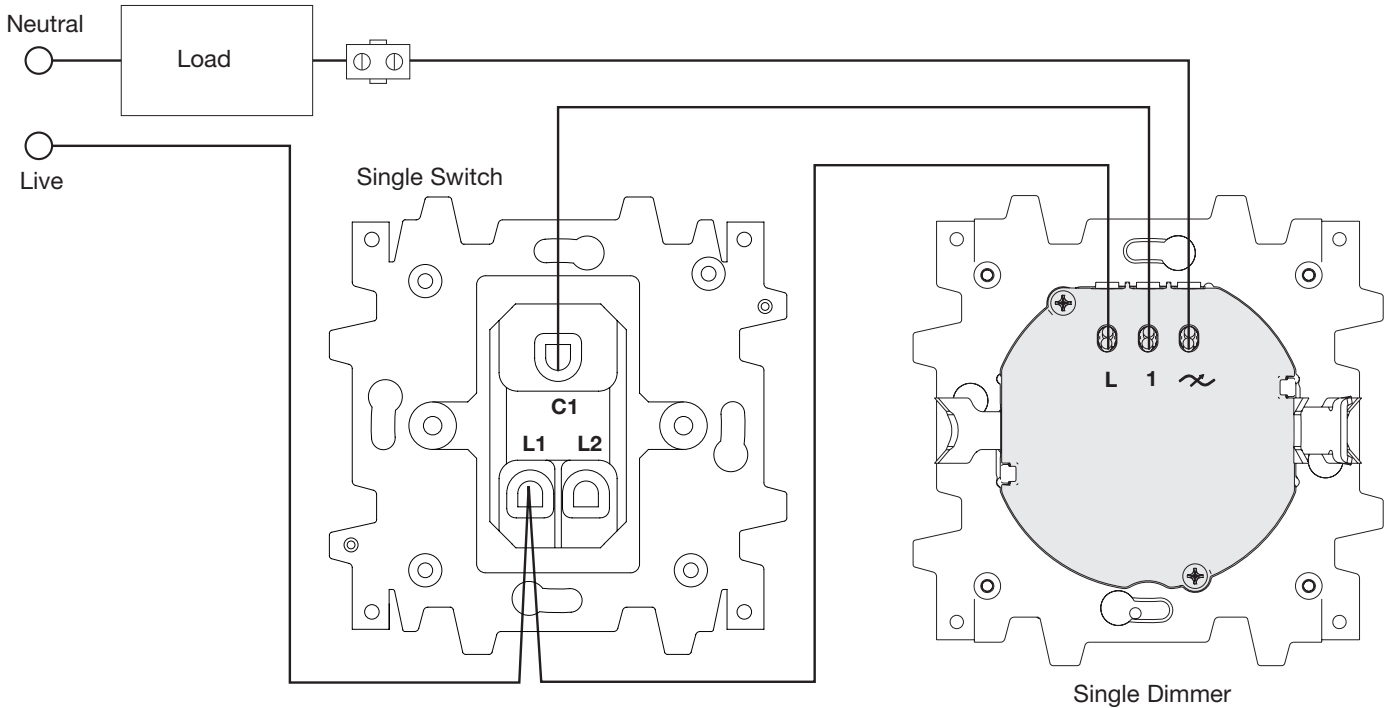

Note: Additional programming is required.

J A Single Dimmer With Two Single Switches (5-Wire Location)

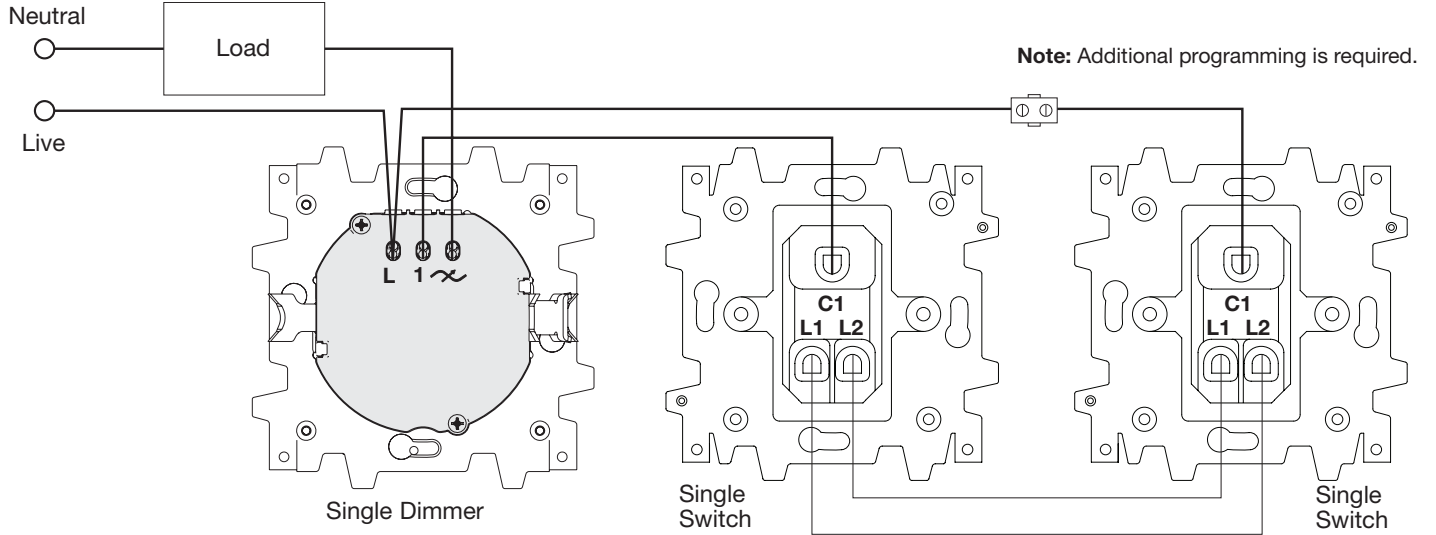

K A Single Dimmer With an Intermediate Switch and a Single Switch (5-Wire Location)

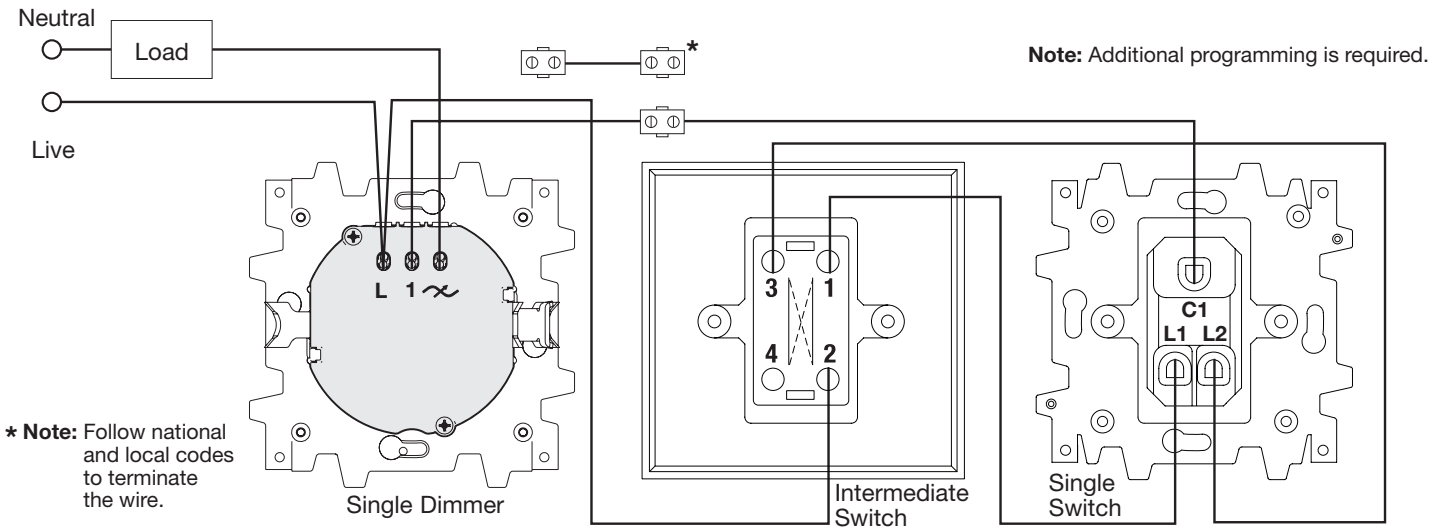

L Two Single Dimmers With A Dual Switch (5-Wire Location)

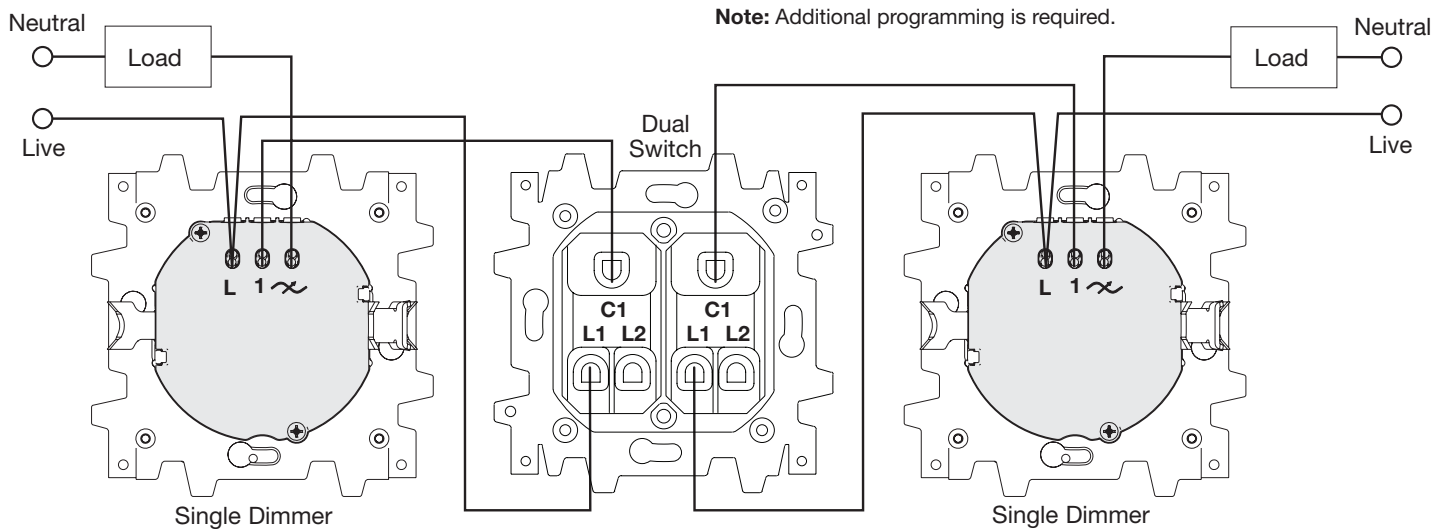

M A Dual Dimmer With a Dual Accessory (10-Wire Location)

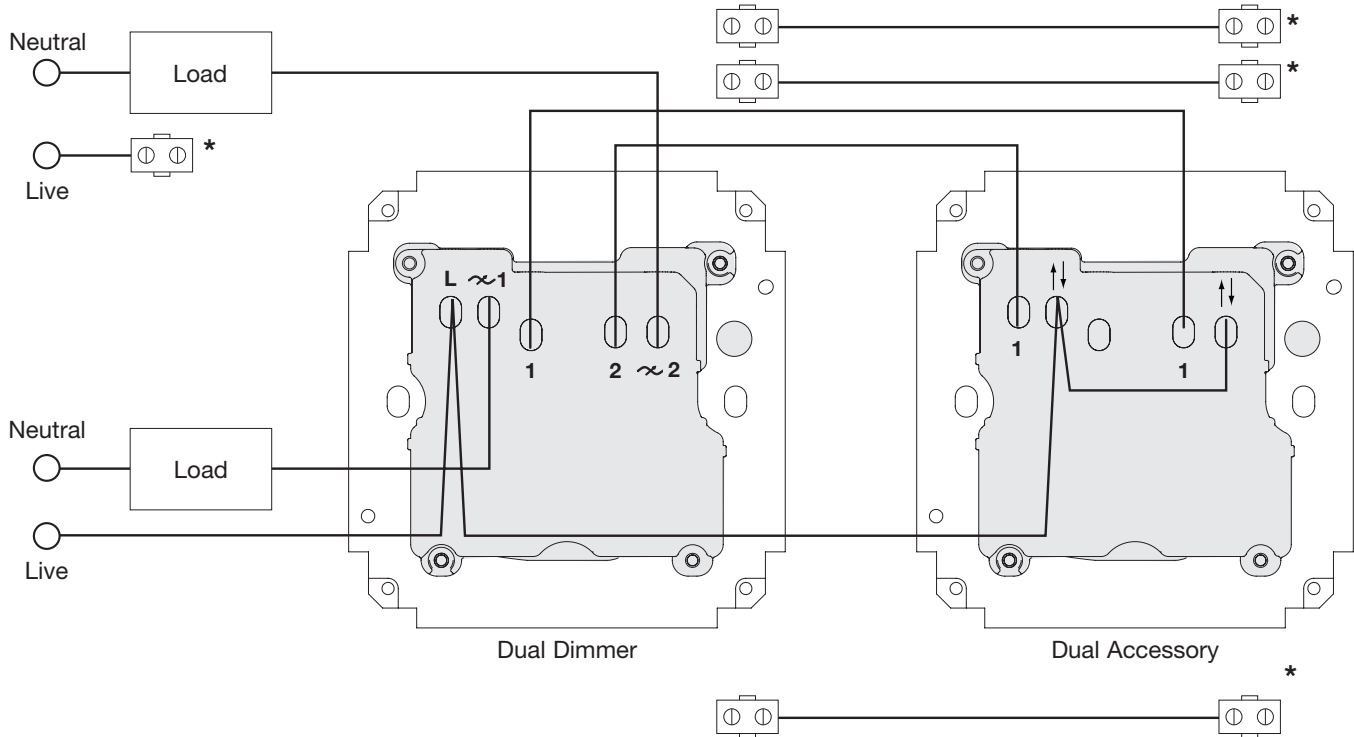

N A Dual Dimmer With a Dual Accessory (6-Wire Location)

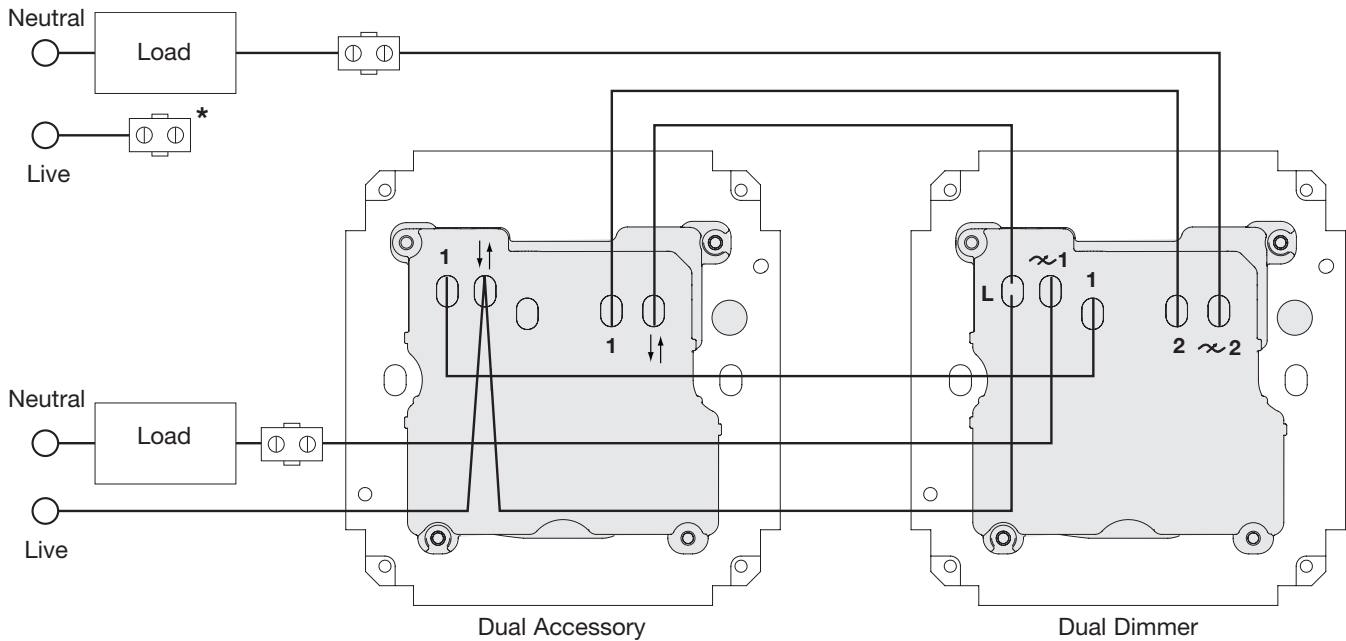

* Note: Follow national and local codes to terminate the wire.

O A Dual Dimmer With Two Dual Accessories (10-Wire Location)

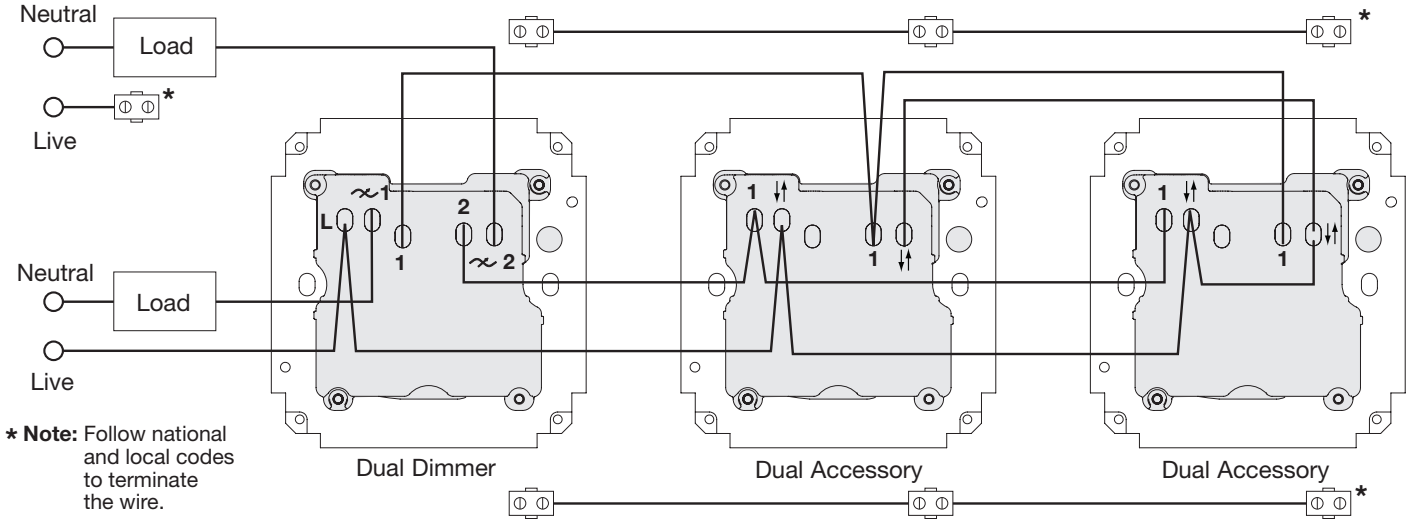

P A Dual Dimmer With Two Dual Accessories (12-Wire Location)

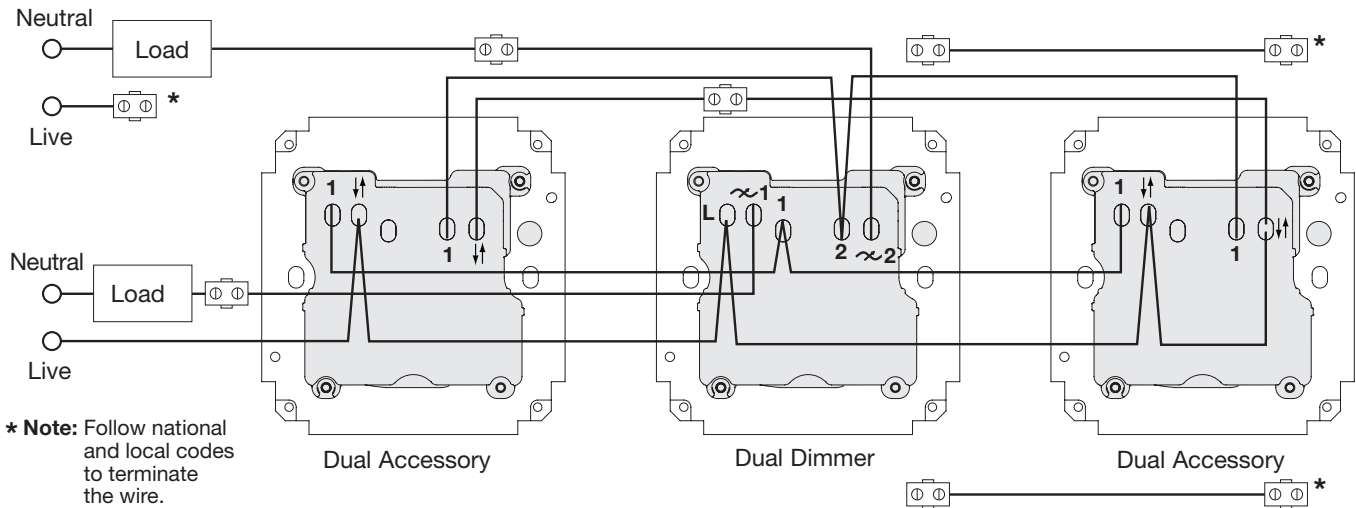

Q A Dual Dimmer With Two Dual Accessories (6-Wire Location)

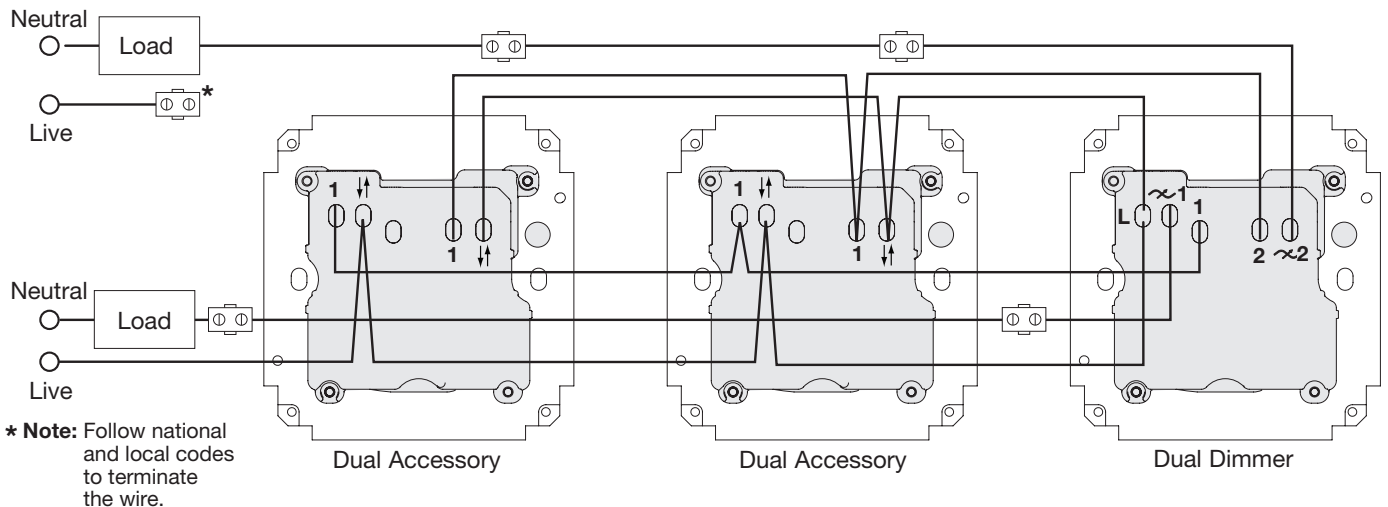

R A Dual Dimmer With Two Single Accessories (10-Wire Location)

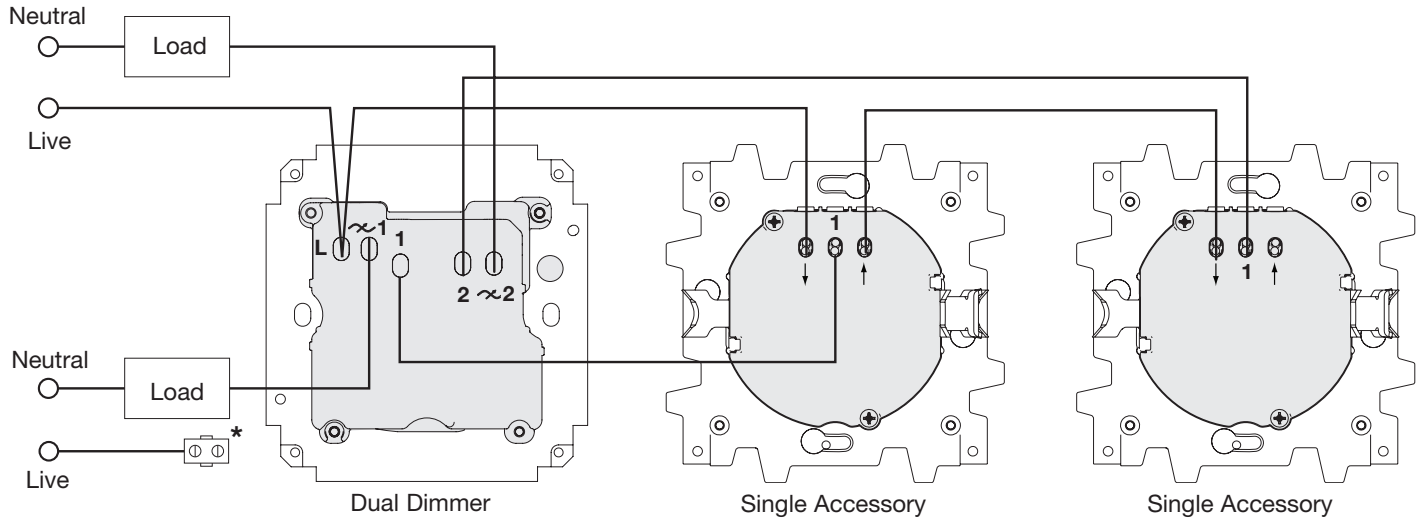

***Note:** Follow national and local codes to terminate the wire.

S A Dual Dimmer With Two Single Accessories (6-Wire Location)

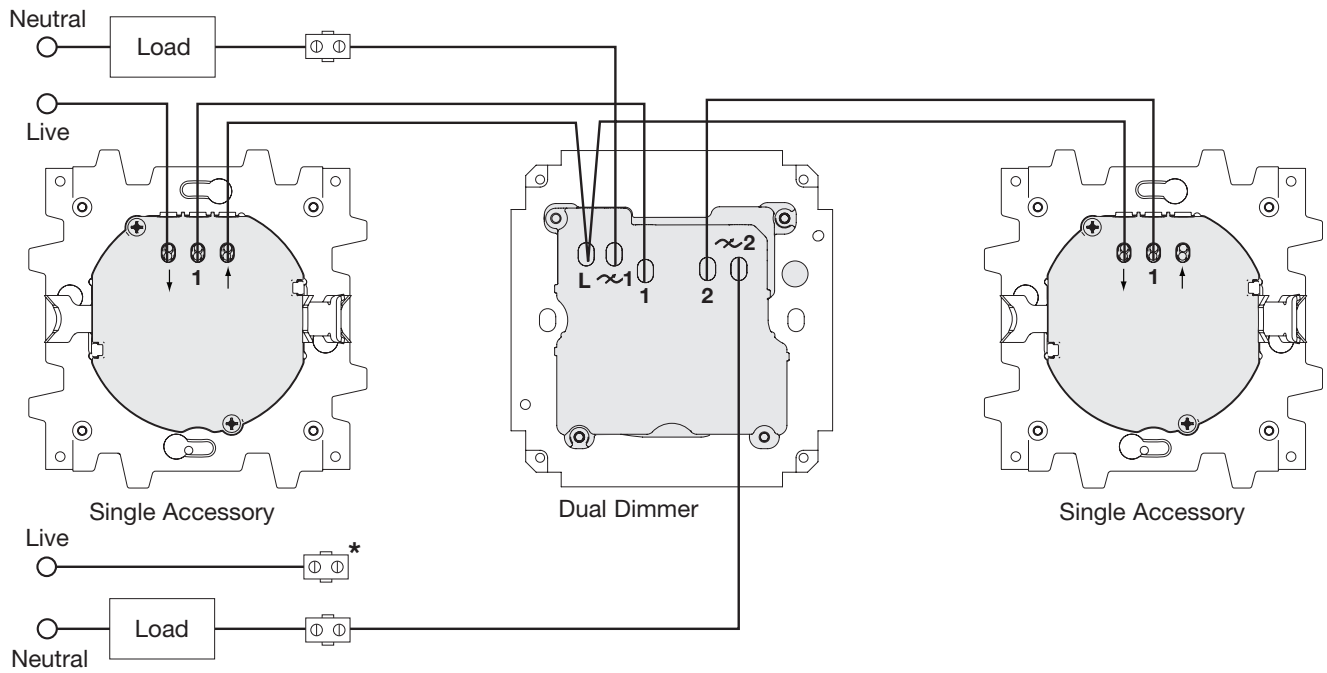

Note: Follow national and local codes to terminate the wire.

T A Dual Dimmer With A Dual Switch (10-Wire Location)

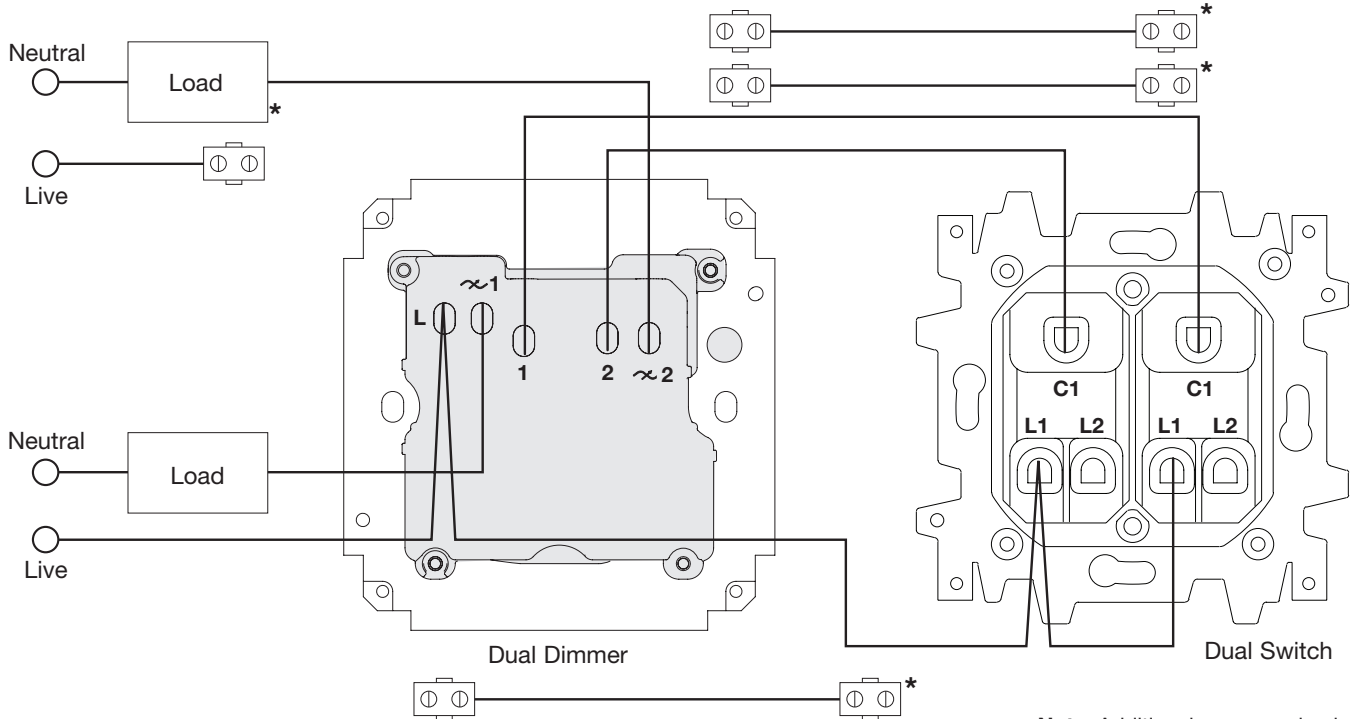

* Note: Follow national and local codes to terminate the wire.

Note: Additional programming is required on a zone connected to a switch.

U A Dual Dimmer With A Dual Switch (6-Wire Location)

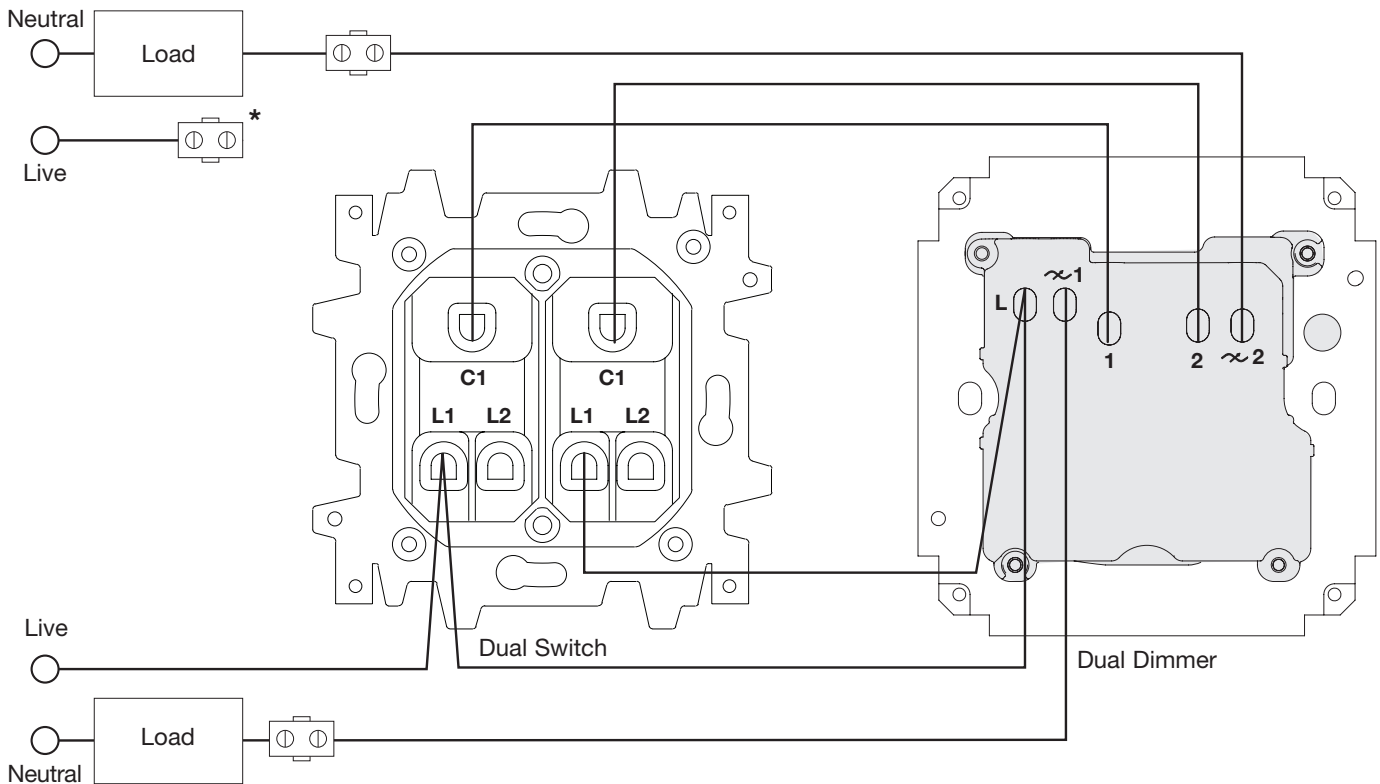

* Note: Follow national and local codes to terminate the wire.

Note: Additional programming is required on a zone connected to a switch.

V A Dual Dimmer With Two Dual Switches (10-Wire Location)

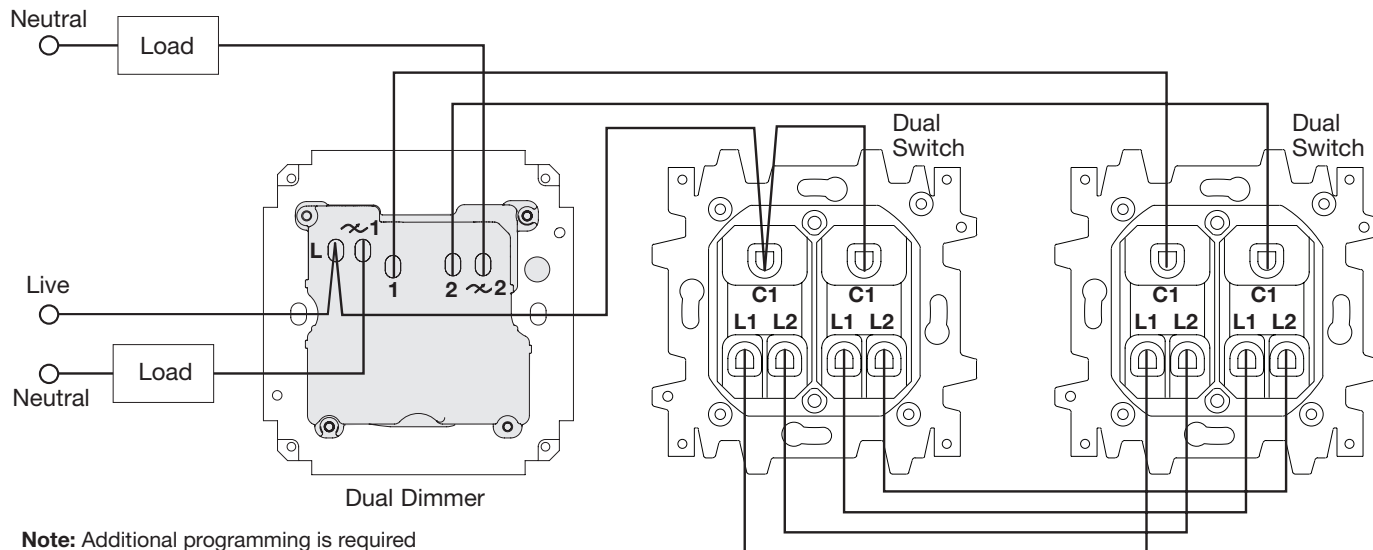

Note: Additional programming is required on a zone connected to a switch.

Changing the Settings on Rania® for Applications with 2-way Switches:

Enter the Advanced Programming mode Menu. To do so make sure the dimmer has power (LEDs should be glowing green), and that the lights are off. If the lights are on, press the Toggle button to turn them off.

The following needs to be performed with the Dual Rania powered on the zone that is wired with a 2-way switch.

- 1** From Electronic OFF – Rania powered, but lights turned off – press and hold Lower (down arrow button) and simultaneously press and hold the Toggle button (big rectangular button above Raise/Lower) until the bottom green LED starts flashing. Once this happens, release both buttons.
- 2** Press Raise (up arrow button) three times, until the fourth LED from the bottom starts flashing.
- 3** Press Toggle once. The bottom LED will start flashing again.
- 4** Press Raise once. Second LED should start flashing.
- 5** Press Toggle once. Fourth LED only should be flashing at this point.
- 6** Press and hold the Toggle button until all the LEDs stop flashing.

Note:

There is a 1 minute timer that will automatically exit the Advanced Programming mode if there is no activity on the dimmer.

To restore the dimmer to factory defaults, repeat step 1 and with the bottom LED flashing, press and hold Raise and Toggle at the same time until the light level begins to rise.

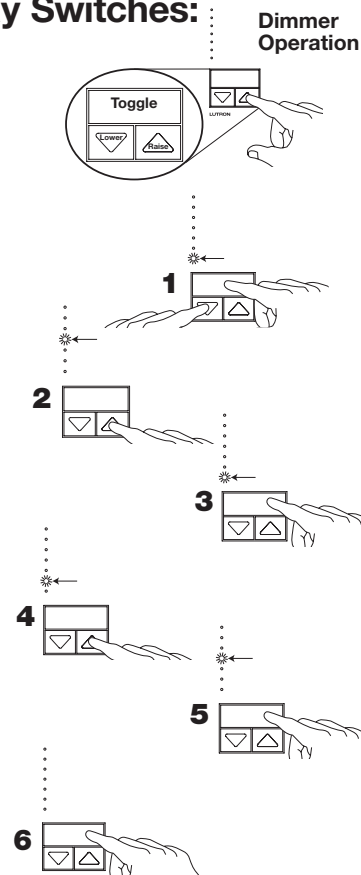

Lutron Contact Numbers

USA, Canada, Caribbean

TEL: +1.610.282.3800
FAX: +1.610.282.1243
Technical Support:
1.800.523.9466
Toll-free:
1.888.LUTRON1
intsales@lutron.com

Central/South America

+1.610.282.6701

United Kingdom

TEL: +44.(0)20.7702.0657
FAX: +44.(0)20.7480.6899
Technical Support:
+44.(0)20.7680.4481
Freephone:
0800.282.107
lutronlondon@lutron.com

Spain, Barcelona

TEL: +34.93.496.57.42
FAX: +34.93.496.57.01
Freephone
900.948.944
lutroniberia@lutron.com

Germany

TEL: +49.(0)30.9710.4590
FAX: +49.(0)30.9710.4591
Freephone:
00800.5887.6635
lutrongermany@lutron.com

France

TEL: +33.(0)1.56.52.93.01
FAX: +33.(0)1.56.52.93.02
Freephone
0800.90.12.18
lutronfrance@lutron.com

Spain, Madrid

TEL: +34.91.567.84.79
FAX: +34.91.567.84.78
Freephone:
900.948.944
lutroniberia@lutron.com

Italy

Freephone:
800.979.208
lutronitalia@lutron.com

Mexico

+1.888.235.2910

Singapore

TEL: +65.6220.4666
FAX: +65.6220.4333
Technical Support:
800.120.4491
lutronsea@lutron.com

China, Beijing

TEL: +86.10.5877.1818
FAX: +86.10.5877.1816
Technical Support:
10.800.712.1536
lutronchina@lutron.com

China, Hong Kong

TEL: +852.2104.7733
FAX: +852.2104.7633
Technical Support:
800.901.849
lutronhk@lutron.com

Japan

TEL: +81.3.5575.8411
FAX: +81.3.5575.8420
Freephone:
0120.083.417
asuka@lutron.com

China, Shanghai

TEL: +86.21.6288.1473
FAX: +86.21.6288.1751
Technical Support:
10.800.120.1536
lutronchina@lutron.com

Indonesia: 001.803.011.3994

Taiwan: 00.801.137.737

Macau: 0800.401

Thailand: 001.800.120.665853

Other Asian Countries:

+65.6220.4666