

ISOMETRIC VIEW

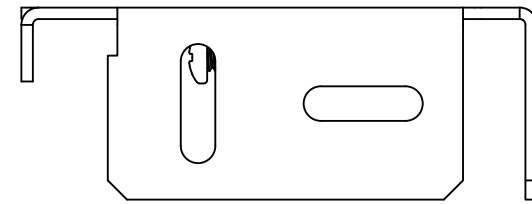

PLAN VIEW

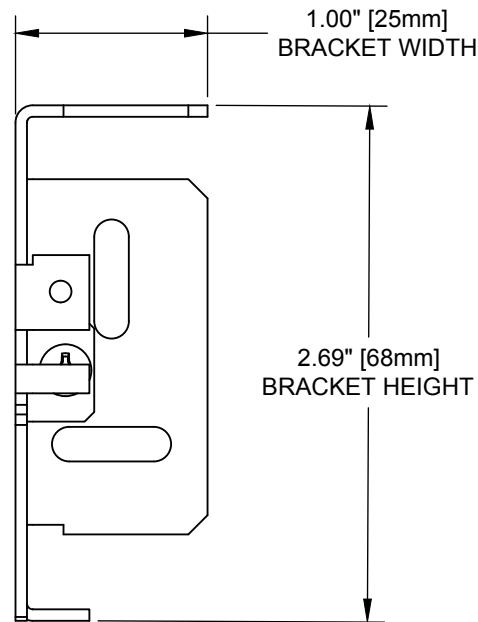

SECTION VIEW

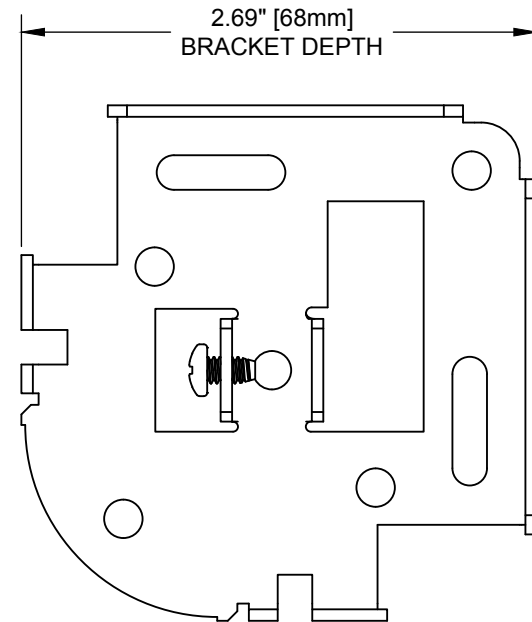

ELEVATION VIEW

ROLLER 20 FASCIA SHADE BRACKET

SCALE: 1/1

DRAWING #: 085539

REVISION: A