

GRAFIK Eye® | 3000/4000 series

Step 1

Determine number of zones and sources

A zone is a group of lights or shades that are always controlled together. **GRAFIK Eye** Controls have the ability to dim most popular sources and to control several zones at one time from one button press. Important factors to consider when creating zones are flexibility of control and aesthetics.

Conference Room Reflected Ceiling Plan

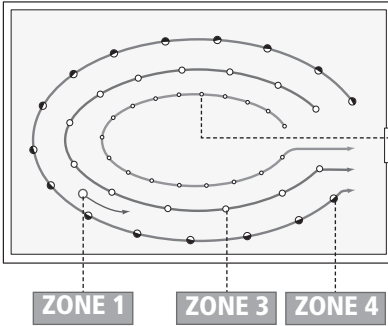

Zone	Description	Voltage	Feed Type (N/E)	Load Type	Fixture Load	No. of Fixtures	Watts/Volt-amps
1	Podium	120	N	INC	75	1	75
ZONE 2	Table	120	N	MLV	50	18	1080*
3	Perimeter	120	N	INC	50	13	650
4	Accent	120	N	FLD	26	16	416

Key: N Normal; E Emergency; INC Incandescent; MLV Magnetic Low-Voltage; FLD Lutron Hi-lume Fluorescent Dimming

* Includes transformer losses

Design Tips

- Dimming Ballasts are required to dim fluorescent sources. For information on Lutron Fluorescent Dimming Ballasts, see pg. 236.
- Transformer loss: Ballasts and transformers draw additional current beyond the lamp rating. For example, magnetic low-voltage transformers typically draw an additional 20% of the lamp wattage.
- If integrating controllable window treatments with the lighting controls, dedicate a zone for each group of treatments to be controlled on GRX-3500 (CPN 1622) Control Units.
- Blank Load schedules are available. See pg. 139.

Step 2

Select GRAFIK Eye® 3000 Series Control Units

Using the number of zones determined in Step 1, select the appropriate size of Control Unit. **GRAFIK Eye** 3000 Series Control Units are available in 2-, 3-, 4-, and 6-zone configurations. Choose a 3500 Model Control Unit if programming the system from a PC or saving light levels at 1% increments is required.

See ordering pgs. 26-28.

This project contains four zones, therefore a GRX-3104 is selected.

Design Tips

- If your space requires more than six zones, link up to eight **GRAFIK Eye** 3000 Series Control Units together for control of up to 48 zones in one system.

For example, for 10 zones in one room:

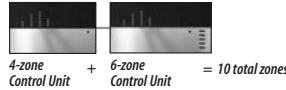

- Use a separate **GRAFIK Eye** Control Unit for each distinct room/space in a project.

Step 3

Select Power Boosters/Interfaces

Specific zones require Power Boosters if load wattage exceeds maximum capacity per zone (max. capacity per zone found on Control Unit ordering pgs. 26-28). **GRAFIK Eye** 3000 Series Controls Units can control incandescent, magnetic low-voltage, neon/cold-cathode, and Lutron **Tu-Wire** fluorescent loads directly. When electronic low-voltage or Hi-Lume/Eco-10 fluorescent loads need to be controlled, a load-specific Power Interface is required.

See ordering pgs. 29-31.

For this project, Zone 2 wattage exceeds maximum capacity for a single zone (800 W/VA maximum). Therefore, a Power Booster, P/N NGRX-PB is required. Zone 4 is controlling **Hi-lume** Fluorescent Dimming Ballasts; therefore, a Fluorescent Dimming Ballast Interface, P/N GRX-FDBI-16A-120 is required.

Design Tips

- For incandescent, magnetic low-voltage, neon/cold cathode, and Lutron **Tu-Wire** Fluorescent Dimming Ballasts, use up to two NGRX-PB Power Boosters to increase individual zone wattage capability (see ordering pg. 30). For multiple load circuits per zone, use **Hi-Power 2•4•6** (see ordering pg. 31).
- Dimming electronic low voltage loads? Use ELVI-1000, Electronic Low Voltage Interface (see ordering pg. 30).
- Dimming Lutron **Hi-lume** or **Eco-10** (ECO-Series) Fluorescent Dimming Ballasts? Use GRX-FDBI, Fluorescent Dimming Ballast Interface (pg. 30 or **Hi-Power 2•4•6** pg. 31).
- A **Hi-Power 2•4•6** must be used for 277V zones (see ordering pg. 31).
- Dimming 0-10V Fluorescent Dimming Ballasts or switching non-dim loads? Use GRX-TVI, Zero to Ten Volt Interface (see ordering pg. 30).

Step 4

Calculate total wattage for all zones. Verify total wattage does not exceed total unit capacity.

If total load for all zones added together is larger than maximum capacity for the Control Unit (max. capacity per Control Unit found on Control Unit ordering pgs. 26-28), add additional Power Boosters/Interfaces to higher wattage zones and recalculate total load. Repeat Step 3 until total load is less than or equal to maximum capacity for the Control Unit selected.

Compare total load to maximum capacity for Control Unit. For this example, total load is 1166 W/VA. Zone 1 (75 Watts) + Zone 2 (Power Booster Load = 25 Watts) + Zone 3 (650 Watts) + Zone 4 (416 Watts) = 1166 Watts. Maximum capacity for a GRX-3104 at 120V is 2000W/VA; therefore, no additional boosting is needed.

Design Tip

- When a Power Booster/Interface is added to a zone, the Power Booster/Interface handles all of the wattage for that zone. Therefore, the load on the GRAFIK Eye Control Unit for that zone becomes 25W/VA.

Step 5

Select and Implement Design Elements

Identify additional control elements for the project (e.g. DMX integration, Event Scheduling, Wireless Control) and add appropriate Wallstations/Control Interfaces to achieve strategies.

For Design Elements available, see pgs. 6-9.

For this project, use an Entrance Control, SG-2BN (see pg. 43) at the door and a Scene Control SG-4SN (see pg. 44), at the podium.

For control from a touchscreen, integrate with the Audio Visual system using a GRX-RS232 (see pg. 59).

Design Tip

- Up to three Wallstations/ Control Interfaces can be powered from a single GRAFIK Eye 3000 Series Control Unit. If additional Wallstations/Control Interfaces (up to 16 total) are needed, a 12VDC power supply must be added. For Lutron GRX-12VDC, see ordering pg. 64.

Step 6

Support the design with one-line diagrams and written product specifications.

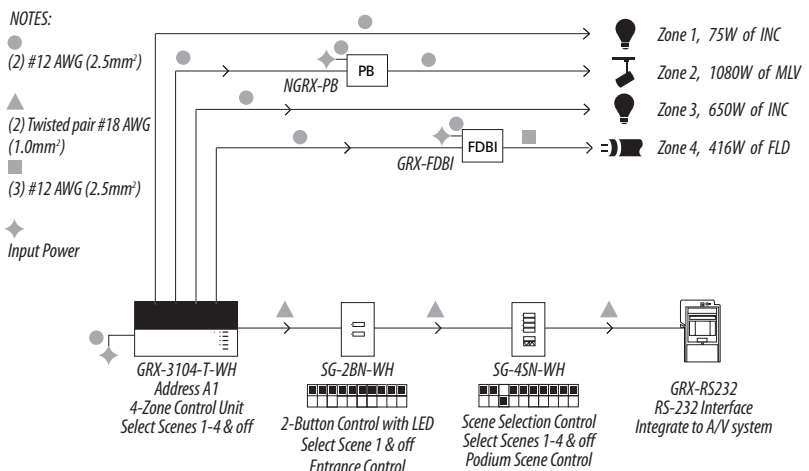

Design Tip

- Complete product specifications are available at www.lutron.com.



Designer™ Software

Lutron's Designer™ software allows faster system design by automatically assigning the types of Power Boosters/Interfaces required from zone load type and wattage information. The software generates a complete bill of materials, including Wallstations and Control Interfaces, with DIP Switch settings, and a one-line diagram that can be saved and exported as a .dxf file. GRAFIK Eye Designer software is available at www.lutron.com/designer.

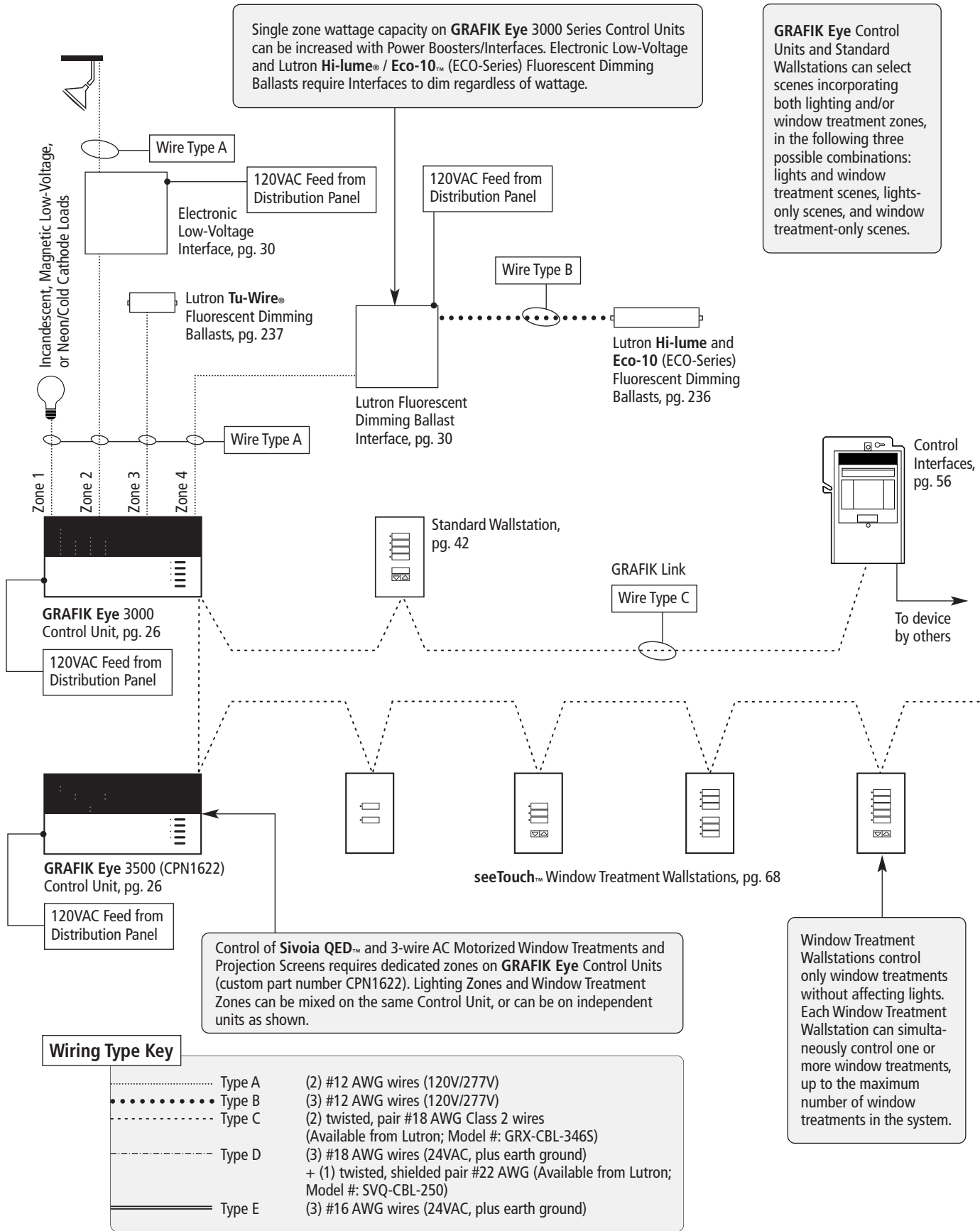

The GRAFIK Eye 3000/4000 Sivoia QED™ Controller, which connects to both the Sivoia QED communication link and the GRAFIK Eye communication link, is used for programming and controlling the group of window treatments wired to the control. Up to a combined total of eight Sivoia QED Controllers and AC Motor Group Controllers can be in one GRAFIK Eye 3000 System.

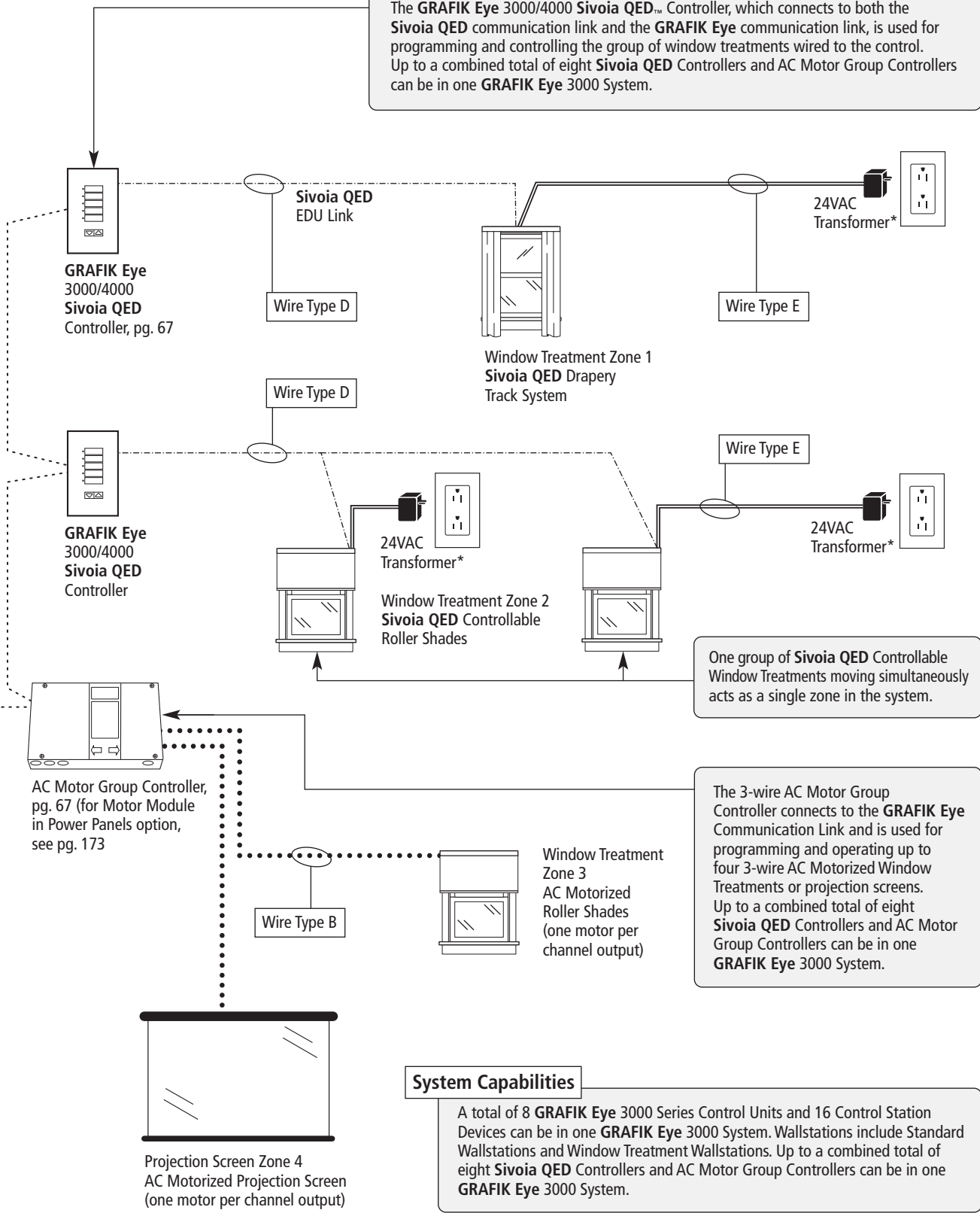

System Capabilities

A total of 8 GRAFIK Eye 3000 Series Control Units and 16 Control Station Devices can be in one GRAFIK Eye 3000 System. Wallstations include Standard Wallstations and Window Treatment Wallstations. Up to a combined total of eight Sivoia QED Controllers and AC Motor Group Controllers can be in one GRAFIK Eye 3000 System.

* Note: Use a Sivoia QED plug-in transformer (shown), a junction box mount transformer, or a Sivoia QED power panel. One Sivoia QED transformer can power only one EDU regardless of window treatment size. The power wiring from the transformer may be up to 200' (61m).

Cover (shown open)



Architectural Grade

- Provides continuously smooth, square law dimming of all lighting zones
- Controls incandescent, magnetic low-voltage, neon/cold-cathode, and Lutron **Tu-Wire**® Fluorescent Dimming Ballasts without additional parts
- Contains Lutron's patented powerline stability circuitry (**RTISS™**-Real Time Illumination Stability System) capable of maintaining constant light levels with no visible flicker under changing powerline conditions
- Provides positive air-gap off for dimmers in each control unit
- Lightning Surge-protected to 6000V, 3000A
- Up to eight **GRAFIK Eye** Control Units can be linked for up to 48 zones
- Built-in Infrared Receiver/Optional Wireless Remote Control
- User-defined lockout options integral; locking covers available, pg. 64
- Offers simple programming for presets; no "store" button required

Compatible Lutron Products

Matching Accessories

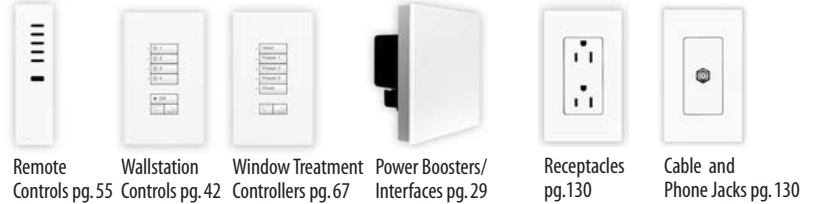

GRAFIK Eye 3000 SYSTEM MAP

- Use the map at right to identify system component being reviewed in each section
- For overall wiring information, See pg. 24

Sources

- Incandescent
- Magnetic Low-Voltage
- Electronic Low-Voltage*
- Fluorescent*
- Neon/Cold Cathode
- Lutron **Tu-Wire**
- High-Intensity Discharge* (non-dim only)
- Controllable Window Treatments*

* Interface required to dim/control. Consult product pages for specifics.

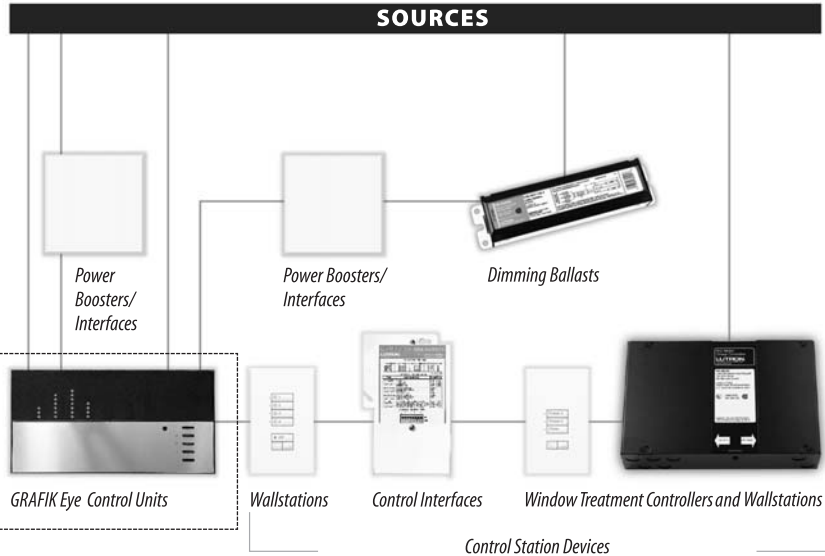

SPECIFICATIONS

- Control Unit requires a single feed
- Single zone capacity can be increased with Power Boosters/Interfaces
- Load Types controlled directly by Control Unit:
 - Incandescent, magnetic low-voltage, neon/cold cathode, Lutron **Tu-Wire** Fluorescent Dimming Ballasts
- Load Types controlled through Power Interfaces: fluorescent and electronic low-voltage
 - For control of **Sivoia QED™** Window Treatments, use SG-SVCN **Sivoia QED** Controller, see pg. 67
 - For control of AC Motorized Window Treatments, use GRX-4M-GC AC Motor Group Controller, see pg. 67 and/or Power Panels with Motor Modules, see pg. 173
- Mounting:
 - Fits standard US wallboxes, 3.50" (89mm) deep strongly recommended, 2.75" (69.9mm) minimum
- Up to total of 8 **Sivoia QED** Controllers plus AC Motor Group Controllers can be in one system with 8 **GRAFIK Eye** Control Units and 16 Control Station Devices

Standards listed below apply to one or more products in the **GRAFIK Eye** product line. Consult factory for specific information.





Dimensions

120V, 220-240V, 100V
W: 5.56" (141mm)
H: 4.56" (116mm)
D: 2.25" (57mm)¹

Wallbox Size:
two-gang, 3.50"
(89mm) deep

230V
W: 8.94" (227mm)
H: 4.56" (116mm)
D: 2.25" (57mm)¹

Wallbox Size:
four-gang, 3.50"
(89mm) deep



Dimensions













120V, 220-240V, 100V
W: 7.25" (184mm)
H: 4.56" (116mm)
D: 2.25" (57mm)¹

Wallbox Size: three-gang,
3.50" (89mm) deep

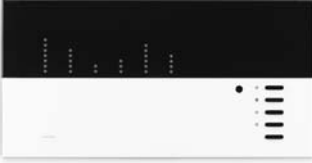
230V
W: 8.94" (227mm)
H: 4.56" (116mm)
D: 2.25" (57mm)¹

Wallbox Size: four-gang,
3.50" (89mm) deep

Source	Product	Max. Capacity	Model	Color	Suffix	
2-ZONE CONTROL UNITS⁴						
	Incandescent, Magnetic Low-Voltage, Neon/Cold Cathode, Lutron Tu-Wire® Fluorescent Dimming Ballasts	800W/VA per zone, 1200W/VA per control unit	120V 3100 3500 ^{2,3}	GRX-3102-__ GRX-3502-__	Ordering Example GRX-3102-T-AU-WH <i>add cover option and color/finish suffix to model #</i> COVER OPTIONS <i>Opaque A</i> <i>Cover and base will match</i> <i>Translucent Black T</i> <i>Black translucent cover with base color from below</i> BASE COLORS Matte Finishes Standard, ships in 48 hrs. • <i>Matte Cover Options: A or T</i> • <i>See pg.10 for complete color offering and suffixes.</i>	
			220-240V (non CE) 3100 3500 ^{2,3}			1200W/VA per zone, 1600W/VA per control unit GRX-3102-__-AU-__ GRX-3502-__-AU-__
			230V (CE) 3100 3500 ^{2,3}			800W/VA per zone, 1600W/VA per control unit GRX-3102-__-CE-__ GRX-3502-__-CE-__
			100V 3100 3500 ^{2,3}			600W/VA per zone, 1000W/VA per control unit GRX-3102-__-JA-__ GRX-3502-__-JA-__
	Electronic Low-Voltage, Fluorescent Electronic low-voltage sources and Lutron Hi-lume® / Eco-10™ (ECO-Series) fluorescent ballasts require interfaces, see pg. 29. Interface is not required for Lutron's Tu-Wire Fluorescent Dimming Ballast.				Gloss (NEMA) Finishes Ships in 4-6 weeks. • <i>Gloss Cover Option: A only</i> • <i>See pg.10 for complete color offering and suffixes.</i>	
			Controllable Window Treatments Sivoia QED™ and 3-wire AC Motorized Window Treatments require Controllers, see pg. 67 and dedicated zones on GRX-350X-X-XXCPN1622 ⁴ Control Units.			
3-ZONE CONTROL UNITS⁴						
	Incandescent, Magnetic Low-Voltage, Neon/Cold Cathode, Lutron Tu-Wire® Fluorescent Dimming Ballasts	800W/VA per zone, 1500W/VA per control unit	120V 3100 3500 ^{2,3}	GRX-3103-__ GRX-3503-__	Satin Finishes Ships in 4-6 weeks. • <i>Satin Cover Option: A or T</i> • <i>See pg.10 for complete color offering and suffixes.</i>	
			220-240V (non CE) 3100 3500 ^{2,3}			1200W/VA per zone, 2400W/VA per control unit GRX-3103-__-AU-__ GRX-3503-__-AU-__
			230V (CE) 3100 3500 ^{2,3}			800W/VA per zone, 2300W/VA per control unit GRX-3103-__-CE-__ GRX-3503-__-CE-__
			100V 3100 3500 ^{2,3}			600W/VA per zone, 1250W/VA per control unit GRX-3103-__-JA-__ GRX-3503-__-JA-__
	Electronic Low-Voltage, Fluorescent Electronic low-voltage sources and Lutron Hi-lume / Eco-10 (ECO-Series) fluorescent ballasts require interfaces, see pg. 29. Interface is not required for Lutron's Tu-Wire Fluorescent Dimming Ballast.				Customization Ships in 4-6 weeks. • <i>See pg. 12 for multigang wallplates, color matching, engraving/silk screening, and custom controls.</i> • <i>See pg. 143 for engraving schedules.</i>	
			Controllable Window Treatments Sivoia QED™ and 3-wire AC Motorized Window Treatments require Controllers, see pg. 67, and dedicated zones on GRX-350X-X-XXCPN1622 ⁴ Control Units.			
	Controllable Window Treatments Sivoia QED™ and 3-wire AC Motorized Window Treatments require Controllers, see pg. 67, and dedicated zones on GRX-350X-X-XXCPN1622 ⁴ Control Units.				Locking Covers • <i>See pg. 64 for more information.</i>	
Footnotes, pg. 27 1 Depth includes wallplate and backbox. Wallplate depth is 0.35" (9mm). 2 3500 Series Control Units can be programmed manually or from a PC and offer the precision of setting light levels in 1% increments. 3 Add CPN1622 to the end of 3500 model number for zone load type selections to operate Sivoia QED and 3-wire AC Motorized Window Treatments. 4 Counts as one of eight total Control Units per system.						

	Source	Product	Max. Capacity	Model	Color	Suffix
 <p>Dimensions 120V, 220-240V, 230V, 100V W: 8.94" (227mm) H: 4.56" (116mm) D: 2.25" (57mm)¹ Wallbox Size: four-gang, 3.50" (89mm) deep</p>	  	4-ZONE CONTROL UNITS⁴				
		Incandescent, Magnetic Low-Voltage, Neon/Cold Cathode, Lutron Tu-Wire® Fluorescent Dimming Ballasts				
		120V 3100 3500 ^{2,3}	800W/VA per zone, 2000W/VA per control unit	GRX-3104- GRX-3504-		
		220-240V (non CE) 3100 3500 ^{2,3}	1200W/VA per zone, 3000W/VA per control unit	GRX-3104- -AU- GRX-3504- -AU-		
		230V (CE) 3100 3500 ^{2,3}	800W/VA per zone, 2300W/VA per control unit	GRX-3104- -CE- GRX-3504- -CE-		
		100V 3100 3500 ^{2,3}	600W/VA per zone, 1600W/VA per control unit	GRX-3104- -JA- GRX-3504- -JA-		
	 	Electronic Low-Voltage, Fluorescent Electronic low-voltage sources and Lutron Hi-lume® / Eco-10™ (ECO-Series) fluorescent ballasts require interfaces, see pg. 29. Interface is not required for Lutron's Tu-Wire Fluorescent Dimming Ballast.				
		Controllable Window Treatments Sivoia QED™ and 3-wire AC Motorized Window Treatments require Controllers, see pg. 67 and dedicated zones on GRX-350X-X-XXCPN1622 ³ Control Units.				
 <p>Dimensions 120V, 220-240V, 230V, 100V W: 8.94" (227mm) H: 4.56" (116mm) D: 2.25" (57mm)¹ Wallbox Size: four-gang, 3.50" (89mm) deep</p>	  	6-ZONE CONTROL UNITS⁴				
		Incandescent, Magnetic Low-Voltage, Neon/Cold Cathode, Lutron Tu-Wire® Fluorescent Dimming Ballasts				
		120V 3100 3500 ^{2,3}	800W/VA per zone, 2000W/VA per control unit	GRX-3106- GRX-3506-		
		220-240V (non CE) 3100 3500 ^{2,3}	1200W/VA per zone, 3000W/VA per control unit	GRX-3106- -AU- GRX-3506- -AU-		
		230V (CE) 3100 3500 ^{2,3}	800W/VA per zone, 2300W/VA per control unit	GRX-3106- -CE- GRX-3506- -CE-		
		100V 3100 3500 ^{2,3}	600W/VA per zone, 1600W/VA per control unit	GRX-3106- -JA- GRX-3506- -JA-		
	 	Electronic Low-Voltage, Fluorescent Electronic low-voltage sources and Lutron Hi-lume / Eco-10 (ECO-Series) fluorescent ballasts require interfaces, see pg. 29. Interface is not required for Lutron's Tu-Wire Fluorescent Dimming Ballast.				
		Controllable Window Treatments Sivoia QED and 3-wire AC Motorized Window Treatments require Controllers, see pg. 67 and dedicated zones on GRX-350X-X-XXCPN1622 ³ Control Units.				
Footnotes, pg. 28 1 Depth includes wallplate and backbox. Wallplate depth is 0.35" (9mm). 2 3500 Series Control Units can be programmed manually or from a PC and offer the precision of setting light levels in 1% increments. 3 Add CPN1622 to the end of 3500 model number for zone load type selections to operate Sivoia QED and 3-wire AC Motorized Window Treatments. 4 Counts as one of eight total Control Units per system.						

Ordering Example

GRX-3104-T-AU-WH
add cover option and color/finish suffix to model #

COVER OPTIONS

Opaque A
Cover and base will match
Translucent Black T
Black translucent cover with base color from below

BASE COLORS

Matte Finishes

Standard, ships in 48 hrs.
 • *Matte Cover Options: A or T*
 • *See pg. 10 for complete color offering and suffixes.*

Gloss (NEMA) Finishes

Ships in 4-6 weeks.
 • *Gloss Cover Option: A only*
 • *See pg. 10 for complete color offering and suffixes.*

Metal Finishes

Ships in 4-6 weeks.
 • *Metal Cover Option: T only*
 • *See pg. 10 for complete color offering and suffixes.*

Satin Finishes

Ships in 4-6 weeks.
 • *Satin Cover Option: A or T*
 • *See pg. 10 for complete color offering and suffixes.*

Customization

Ships in 4-6 weeks.
 • *See pg. 12 for multigang wallplates, color matching, engraving/silk screening, and custom controls.*
 • *See pg. 143 for engraving schedules.*

Locking Covers

• *See pg. 64 for more information.*



Hi-Power 2•4•6™



Zero to Ten Volt
Interface/Switching Relay

- Increases single-zone load capacity (as required)
- Models available to control fluorescent and electronic low-voltage loads
- Switching Relay provides 16A switching capacity for non-dim loads

Compatible Lutron Products



Power Booster



Electronic
Low-Voltage
Interface



Lutron Fluorescent
Dimming Ballast
Interface



Dimming Ballasts pg. 236



GRAFIK Eye 3000
Control Units pg. 26

GRAFIK Eye 3000 SYSTEM MAP

- Use the map at right to identify system component being reviewed in each section
- For overall wiring information, See pg. 24

Sources

- Incandescent
- Magnetic Low-Voltage
- Electronic Low-Voltage
- Fluorescent
- Neon/Cold Cathode
- Lutron Tu-Wire®
- High-Intensity Discharge (non-dim only)

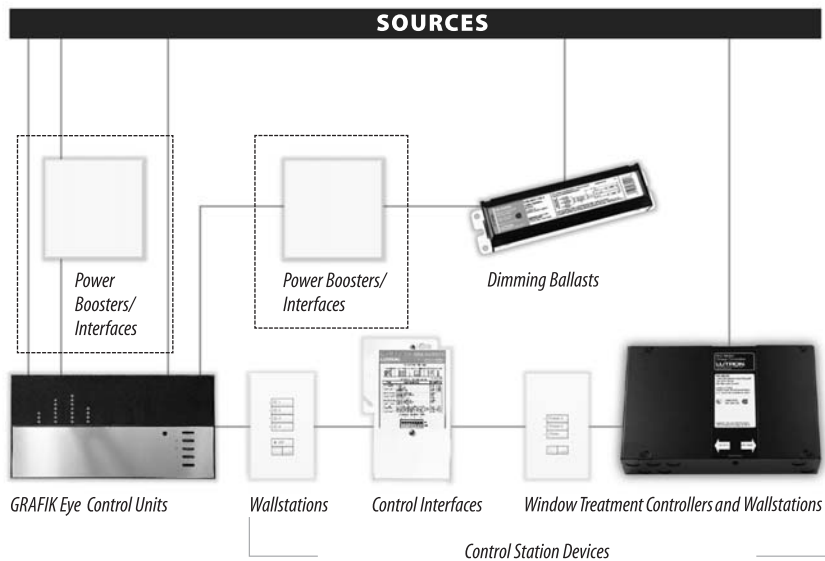

SPECIFICATIONS

All Power Booster/Interfaces:



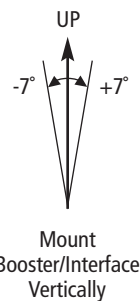











- All voltages indicated are phase-to-neutral and will operate on 50 or 60Hz power
- Require a circuit feed; load circuit feed is phase independent of control circuit from dimmer
- Are not plenum-rated; for indoor use only
- When mounting several units in vertical layout, allow 4.5" (114mm) between units for heat dissipation
- Must be mounted within 7° of true vertical
- Generate heat; mount only where ambient temperature will be 0-40°C (32°-104°F) with a non-condensing relative humidity <90%
- Common neutrals are not permitted; run separate neutrals for each load circuit
- Up to two Power Boosters/Interfaces can be wired to a single zone for greater capacity



Standards listed below apply to one or more products in the GRAFIK Eye product line. Consult factory for specific information.

LUTRON
Quality Systems
registered
to ISO 9001



	Source	Product	Max. Capacity	Model													
 <p>Dimensions W: 4.56" (116mm) H: 4.56" (116mm) D: 0.69" (18mm)³ Wallbox Size: two-gang; minimum 3" depth</p>	   	POWER BOOSTER² <ul style="list-style-type: none"> Increases single GRAFIK Eye zone wattage capacity Dims incandescent, magnetic low-voltage, neon/cold cathode loads, and Lutron's Tu-Wire® Fluorescent Dimming Ballasts Can also be used to switch (non-dim) all of the sources mentioned above Up to two Power Boosters can be wired to a single GRAFIK Eye zone <table border="1"> <tr> <td>120V</td> <td>2000W/VA⁴</td> <td>NGRX-PB-WH</td> </tr> <tr> <td>100V</td> <td>1600W/VA</td> <td>NGRX-PB-JA-WH</td> </tr> <tr> <td>220-240V (non CE)</td> <td>2400W/VA</td> <td>NGRX-PB-AU-WH</td> </tr> <tr> <td>230V (CE)</td> <td>1200W/VA (with Wallplate) 1840W/VA (without Wallplate)</td> <td>NGRX-PB-CE-WH</td> </tr> </table>			120V	2000W/VA ⁴	NGRX-PB-WH	100V	1600W/VA	NGRX-PB-JA-WH	220-240V (non CE)	2400W/VA	NGRX-PB-AU-WH	230V (CE)	1200W/VA (with Wallplate) 1840W/VA (without Wallplate)	NGRX-PB-CE-WH	Ordering Example NGRX-PB-WH Ships in 48 hrs.
		120V	2000W/VA ⁴	NGRX-PB-WH													
		100V	1600W/VA	NGRX-PB-JA-WH													
		220-240V (non CE)	2400W/VA	NGRX-PB-AU-WH													
230V (CE)	1200W/VA (with Wallplate) 1840W/VA (without Wallplate)	NGRX-PB-CE-WH															
 <p>Dimensions W: 4.56" (116mm) H: 4.56" (116mm) D: 0.69" (18mm)³ Wallbox Size: two-gang; minimum 3" depth</p>		ELECTRONIC LOW-VOLTAGE INTERFACE² <ul style="list-style-type: none"> Allows dimming of electronic transformer-supplied low-voltage lighting requiring reverse phase-control dimming Up to two interfaces can be wired to a single GRAFIK Eye zone <table border="1"> <tr> <td>120V</td> <td>1000W</td> <td>ELVI-1000</td> </tr> <tr> <td>100V</td> <td>1000W</td> <td>NGRX-ELVI-JA-WH</td> </tr> <tr> <td>220-240V (non CE)</td> <td>1200W</td> <td>NGRX-ELVI-AU-WH</td> </tr> <tr> <td>230V (CE)</td> <td>1200W</td> <td>NGRX-ELVI-CE-WH</td> </tr> </table>			120V	1000W	ELVI-1000	100V	1000W	NGRX-ELVI-JA-WH	220-240V (non CE)	1200W	NGRX-ELVI-AU-WH	230V (CE)	1200W	NGRX-ELVI-CE-WH	
		120V	1000W	ELVI-1000													
		100V	1000W	NGRX-ELVI-JA-WH													
		220-240V (non CE)	1200W	NGRX-ELVI-AU-WH													
230V (CE)	1200W	NGRX-ELVI-CE-WH															
 <p>Dimensions W: 4.56" (116mm) H: 4.56" (116mm) D: 0.69" (18mm)³ Wallbox Size: two-gang; minimum 3" depth</p>		LUTRON FLUORESCENT DIMMING BALLAST INTERFACE² <ul style="list-style-type: none"> Allows dimming of Lutron Hi-Lume®/Eco-10™ (ECO-Series) line voltage control Electronic Dimming Ballasts only Not to be used for switching Up to two interfaces can be wired to a single GRAFIK Eye zone <table border="1"> <tr> <td>120V</td> <td>16A</td> <td>GRX-FDBI-16A-120</td> </tr> <tr> <td>100V</td> <td>16A</td> <td>NGRX-FDBI-JA-WH</td> </tr> <tr> <td>220-240V (non CE)</td> <td>10A</td> <td>NGRX-FDBI-AU-WH</td> </tr> </table>			120V	16A	GRX-FDBI-16A-120	100V	16A	NGRX-FDBI-JA-WH	220-240V (non CE)	10A	NGRX-FDBI-AU-WH				
		120V	16A	GRX-FDBI-16A-120													
		100V	16A	NGRX-FDBI-JA-WH													
		220-240V (non CE)	10A	NGRX-FDBI-AU-WH													
 <p>Dimensions W: 6.10" (155mm) H: 12.50" (318mm) D: 3.30" (84mm) Surface Mount</p>	   	ZERO TO TEN VOLT INTERFACE <table border="1"> <tr> <td></td> <td></td> <td>GRX-TVI</td> </tr> </table> <ul style="list-style-type: none"> Allows dimming of Lutron Eco-10 (ECO-Series) Electronic Dimming Ballasts 0-10V output rating: 10µA-300mA; sinks current only Up to five interfaces can be wired to a single GRAFIK Eye zone <table border="1"> <tr> <td>120V, 277V, 220-240V, 100V, 230V (CE)</td> <td>16A</td> <td>(same model number for all voltages)</td> </tr> </table>					GRX-TVI	120V, 277V, 220-240V, 100V, 230V (CE)	16A	(same model number for all voltages)							
				GRX-TVI													
		120V, 277V, 220-240V, 100V, 230V (CE)	16A	(same model number for all voltages)													
		SWITCHING RELAY <table border="1"> <tr> <td></td> <td></td> <td>GRX-TVI</td> </tr> </table> <ul style="list-style-type: none"> Switching relay (non-dim) ratings for all voltages 16A: Incandescent, Low Voltage, Neon/Cold Cathode, Metal Halide, Fluorescent (capacitive), Non-capacitive 1/4 hp: 120V—Motor 1/2 hp: 240V—Motor <table border="1"> <tr> <td>120V, 277V, 220-240V, 100V, 230V (CE)</td> <td>16A</td> <td>(same model number for all voltages)</td> </tr> </table>					GRX-TVI	120V, 277V, 220-240V, 100V, 230V (CE)	16A	(same model number for all voltages)							
		GRX-TVI															
120V, 277V, 220-240V, 100V, 230V (CE)	16A	(same model number for all voltages)															
Footnotes, pg. 30 <ol style="list-style-type: none"> All voltages indicated are phase-to-neutral. Load circuit feed is phase independent of control circuit from dimmer. Depth is from Wallplate to wall. Wallplate depth is 0.35" (9mm). Measured current will not exceed continuous load rating due to voltage drop in the dimmer. 																	



**Dimensions—
HP 2,4,6**

W: 10.38" (264mm)
H: 14.50" (368mm)
D: 5.75" (146mm)
wt: 15 lbs (6.8kg)
Surface Mount

Source Product Max. Capacity Model

HI-POWER 2-4-6™ DIMMING MODULE²



- Up to five modules can be daisy-chained for greater capacity up to 30,000 W/VA
- Rated for 120V or 277V¹; not for 100V, 230V, 220-240V
- 277V for fluorescent and magnetic low-voltage loads only
- Do not use generator-supplied power
- Modules generate audible noise; mount where acceptable

1 CIRCUIT	2000W/VA	HP-2
2 CIRCUITS	4000W/VA	HP-4
3 CIRCUITS	6000W/VA	HP-6

Ordering Example

HP-2
Ships in 48 hrs.

MAXIMUM CAPACITY³ - 120V

Model	Total Load		Inputs		Outputs		Maximum Heat Dissipation (BTUs/hr) ⁴
	MAXIMUM ⁵	MINIMUM	LOAD CIRCUITS 120VAC, 60Hz	CONTROL CIRCUIT 120VAC, 60Hz	DIMMED HOT	SWITCHED HOT	
HP-2	2000W/VA	50W/VA	1	1	1	1	200 BTUs/hr
HP-4	4000W/VA	100W/VA	2	1	2	2	400 BTUs/hr
HP-6	6000W/VA	150W/VA	3	1	3	3	600 BTUs/hr

MAXIMUM CAPACITY³ - 277V

Model	Total Load		Inputs		Outputs		Maximum Heat Dissipation (BTUs/hr) ⁴
	MAXIMUM	MINIMUM	LOAD CIRCUITS 277VAC, 60Hz	CONTROL CIRCUIT 120VAC, 60Hz	DIMMED HOT	SWITCHED HOT	
HP-2	4432W/VA	50W/VA	1	1	1	1	200 BTUs/hr
HP-4	8864W/VA	100W/VA	2	1	2	2	400 BTUs/hr
HP-6	13296W/VA	150W/VA	3	1	3	3	600 BTUs/hr

LOAD CAPACITY PER CIRCUIT

LAMP TYPE	DIMMED	SWITCHED
120V		
Incandescent	16A, 1920W	10A, 1200W
Magnetic Low-Voltage	16A, 1920VA	10A, 1200VA
Electronic Low-Voltage	16A, 1920W	10A, 1200W
Fluorescent—Lutron Hi-lume ®/ Eco-10 _m (ECO-Series)/ Tu-Wire ®	16A,	16A
Fluorescent (non-capacitive)		10A
Fluorescent (electronic)		10A
HID		10A
Neon/Cold Cathode	16A, 1920VA	10A, 1200VA
277V		
Magnetic Low-Voltage	16A, 4432VA	
Fluorescent—Lutron Hi-lume ®/ Eco-10 (ECO-Series)/ Tu-Wire	16A,	

Footnotes, pg. 31

- 1 All voltages indicated are phase-to-neutral.
- 2 Load circuit feed is phase independent of control circuit from dimmer.
- 3 Up to five HP Modules can be wired to one GRAFIK Eye zone.
- 4 Maximum BTUs/hr are based on all circuits at full load; panels loaded less than full produce proportionately lower BTUs/hr.
- 5 Measured current will not exceed continuous load rating due to voltage drop in the dimmer.