

## Hi-lume Premier 0.1% EcoSystem LED Driver

Hi-lume Premier 0.1% EcoSystem LED Drivers provide a high-performance solution for any space, in any application. They provide smooth, continuous dimming down to 0.1% of full output current, and fade smoothly between 100% and 0.1% with Soft-on, Fade-to-Black.

### Features

- Soft-on, Fade-to-Black: fades smoothly between 100% and 0.1% when turned on and off for an incandescent-like experience.
- Continuous, flicker-free dimming from 100% to 0.1%<sup>1</sup>.
- Dimming Method:
  - Constant-current reduction dimming provides video-friendly performance down to 0.1%.
- Guaranteed dimming performance when used with Lutron controls:
  - HomeWorks QS, Energi Savr Node units with EcoSystem controls, GRAFIK Eye QS with EcoSystem controls, PowPak with EcoSystem dimming modules, PowPak with EcoSystem wireless fixture controls, and Quantum systems, allowing for integration into a planned or existing EcoSystem lighting control solution.
- QwikFig compatible models available, see **How to Build a Model Number** page for details. For more information, please refer to the QwikFig User Guide (Lutron P/N 041473) or contact your Lutron sales representative.
- Protected from miswires of input power to EcoSystem control inputs up to 277 V $\sim$ .
- Rated lifetime of 50,000 hours at 80 °C (176 °F) calibration point ( $t_0$ ).
- Designed for FCC Part 15 Class A. Final performance is dependent on fixture design.
- 100% performance tested at factory before shipping.
- RoHS compliant.
- Non-volatile memory restores all settings after power failure.
- For more information, visit [www.lutron.com](http://www.lutron.com)

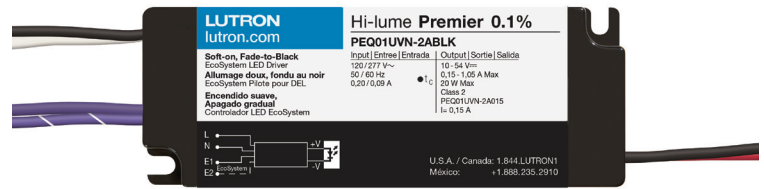

### Case type V

1.60 in (40.64 mm) W x 1.07 in (27.18 mm) H x 4.30 in (109.22 mm) L

### EcoSystem Features

- Simpler to wire and more reliable than 0–10 V $\sim$ .
- Guarantees compatibility between Lutron controls, LED drivers, ballasts, and sensors.
- Accommodates zone and control changes without re-wiring.
- Connect to Lutron Vive and Quantum Total Light Management Systems to monitor lighting power consumption.
- Polarity-free and topology-free.
- Digital EcoSystem intelligence allows easy code compliance.
- Digital EcoSystem control link can be Class 1 or Class 2.

<sup>1</sup> Light output at low-end depends on the efficacy of the LED light engine used with the driver.

Job Name:	Model Numbers:
Job Number:	

## Specifications

### Regulatory Approvals and Compliance

- UL® Listed Class P
- NOM certified for Mexico
- Lutron Quality Systems registered to ISO 9001.2015
- Manufacturing facilities employ ESD reduction practices that comply with the requirements of ANSI/ESD S20.20
- Inrush current less than NEMA® 410-2011 limit
- Designed for FCC Part 15 Class A. Final performance is dependent on fixture design
- Canadian EMI Class A Compliance Equivalent: CAN ICES-005(A)/NMB-005(A)
- Meets UL® 8750, “Light Emitting Diode (LED) Equipment For Use in Lighting Products”
- Class 2 output

### ENERGY STAR® Luminaires V2.0 Specification

- LED drivers need to meet certain performance criteria in order for the completed luminaires to comply with the ENERGY STAR® Luminaires V2.0 Specification
- PEQ0 models meet performance criteria at 120 V $\sim$  input and when driver output power exceeds 5 W
- PEQ0 models meet performance criteria at 277 V $\sim$  input and when driver output power exceeds 13 W

### Title 24

- LED drivers need to meet certain performance criteria in order for the completed luminaires to comply with Title 24 requirements as detailed in Reference Joint Appendix JA8
- PEQ0 models meet performance criteria at 120 V $\sim$  input and when driver output power exceeds 10 W
- Consult **CEC-400-2015-032-CMF Section 6.2.7** for important information on meeting start-up time requirements with fade-in lighting

### Performance

- Soft-on, Fade-to-Black: fades smoothly between 0% and 0.1% when turned on and off for an incandescent-like experience
- Dimming Range: 100% to 0.1%<sup>1</sup>
- Operating Voltage: 120 V $\sim$  / 277 V $\sim$  at 50/60 Hz
- Lifetime: 50,000 hours when calibration point ( $t_c$ ) at 80 °C (176 °F)<sup>2</sup>
- For rated warranty,  $t_c$  not to exceed 80 °C (176 °F) (maximum rated temperature)<sup>2</sup>
- Patented thermal foldback protection
- At turn on, lighting fades smoothly to the desired level without decreasing or flashing to full brightness
- Non-volatile memory restores all driver settings after power failure
- Typical standby power consumption: < 0.5 W at 120 V $\sim$  / 277 V $\sim$
- Open-circuit protected output
- Short-circuit protected output

<sup>1</sup> Light output at low-end depends on the efficacy of the LED light engine used with the driver.

<sup>2</sup> To maintain warranty, installer is responsible for ensuring that the driver calibration point does not exceed 80 °C (176 °F).

Job Name:	Model Numbers:
Job Number:	

## Specifications (continued)

### Environmental

- Sound rated: Class A inaudible in 24 dBA ambient
- Relative Humidity: maximum 90% non-condensing
- Minimum Operating Ambient Temperature:  
 $t_a = 0\text{ }^\circ\text{C}$  (32  $^\circ\text{F}$ )<sup>1</sup>
- Indoor use only
- Rated for dry and damp locations

### Driver Wiring and Mounting

- Fixture must be grounded in accordance with local and national electrical codes
- Use only within an enclosure
- Includes 6 in (152 mm) leads of stranded 18 AWG (0.75 mm<sup>2</sup>), 600 V $\sim$  and 105  $^\circ\text{C}$  (221  $^\circ\text{F}$ ) rated. Stripped to 0.5 in (12.7 mm)
- Maximum driver-to-LED light engine wire length for:

Wire Gauge	Maximum Lead Length		
	150 mA to 700 mA	710 mA to 1.50 A	1.51 A to 2.10 A
18 AWG (0.75 mm <sup>2</sup> )	30 ft (9 m)	15 ft (4.5 m)	10 ft (3 m)
16 AWG (1.5 mm <sup>2</sup> )	35 ft (10.5 m)	25 ft (7.5 m)	15 ft (4.5 m)
14 AWG (2.5 mm <sup>2</sup> )	50 ft (15 m)	40 ft (12 m)	25 ft (7.5 m)
12 AWG (4.0 mm <sup>2</sup> )	100 ft (30 m)	60 ft (18 m)	40 ft (12 m)

<sup>1</sup> Where  $t_a$  is the temperature of the air directly surrounding the driver

Job Name:	Model Numbers:
Job Number:	

## How to Determine Compatibility Between an LED Driver and LED Load

1. Review the specifications of the LED load.
2. Identify the minimum and maximum operating voltage of the LED load at the desired operating current. This “current” will be the rated output current of the LED driver. Consult the LED load manufacturer for any questions.

**Example:** An LED load that is rated at 0.7 A and 30 V nominally, has an input (forward) voltage range of 25–35 V (at 0.7 A) due to unit-to-unit variation, temperature, etc.

3. Examine the **LED Driver Load Compatibility** graphs below for each output range to ensure that the voltage range of the LED load is within the load compatibility range.

**Example:** Lines marked below indicate two load specifications:

Load A (25 – 35 V) at 0.5 A

Load B (25 – 35 V) at 0.7 A

### Load B (Not Compatible) ❌

Since the maximum voltage of the load, 35 V, exceeds the 28.5 V allowable at 0.7 A, this combination of LED load and LED driver is not compatible.

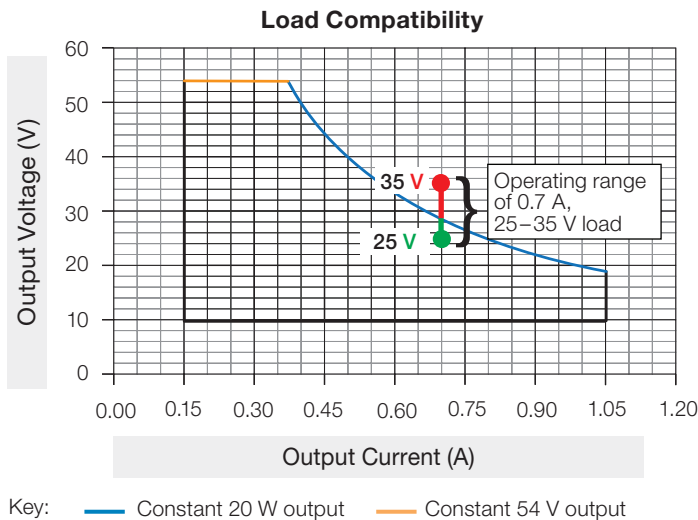

### Load A (Compatible) ✅

Operating voltage range for load A is 25 – 35 V at 0.5 A. Since the load specifications are within the operating range, the combination of LED Load and LED Driver is compatible.

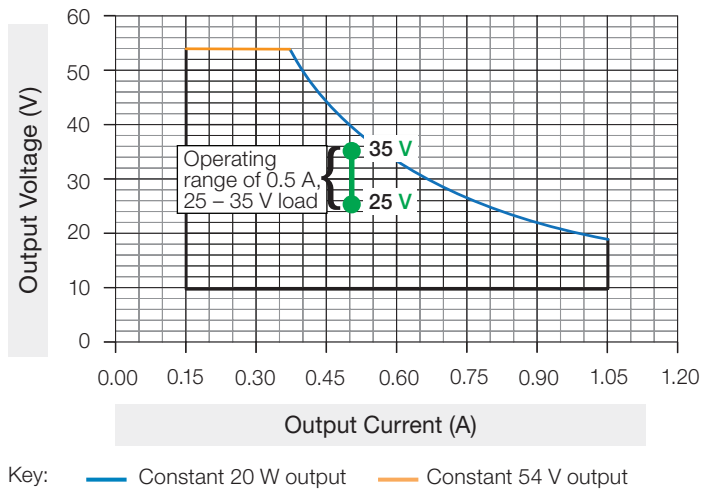

4. The [LED Driver Selection Tool](#) is a website compatibility tool that allows for a fast compatibility search of all Lutron LED Drivers that are compatible with an LED Load.
5. See **How to Build A Model Number** to create the appropriate model number for the desired driver. If a QwikFig compatible driver is needed, identify the proper **LED Load Output Range** (voltage and current) and insert “BLK” in the **Current Level (for Constant Current)** section of the model number.

Job Name:	Model Numbers:
Job Number:	

## Load Learning

### What is load learning?

Each Lutron constant-current LED driver is able to operate over a range of LED load voltages. In order to operate with optimum efficiency, these drivers continuously sense the LED load voltage and make adjustments to their internal operation.

### When does load learning happen?

Load learning happens continuously and in most cases is imperceptible. However, when a new load is connected to the driver it will take some time for the LED driver to adapt. A driver may be performing load learning during R&D/bench testing, production testing, or QwikFig/AirFig configuration when using a real load. If a driver was not allowed to learn its load during the fixture production process, it may happen when first installed in the final location.

### What does load learning look like?

Depending on the difference in forward voltage of the new load versus the last load the driver learned, one of the following may be observed:

1. The load may seem to operate properly.
2. The load may turn on at a low light level and remain there for a few seconds before transitioning to full light.
3. The load may turn on for a very brief flash, then go off for a few seconds before turning back on again.
4. There may be no light output at all for up to 20 seconds.

### How do I make a driver “learn” a new load?

Although this process will happen on its own during normal usage, Lutron recommends the following procedure be carried out before attempting to confirm proper operation:

1. Power up the LED driver on the intended load.
2. Once the light seems to be stable at full output, which may take 20 to 30 seconds, leave the driver on for another 20 seconds for the driver to learn the load voltage and commit it to memory.

**Note:** There is no limit to the number of times a driver can learn a new load.

Job Name:	Model Numbers:
Job Number:	

## How to Build a Model Number, V-Case Type (“BLK” models for use with Lutron QwikFig technology): Hi-lume Premier 0.1% EcoSystem LED Driver with Soft-On, Fade-to-Black

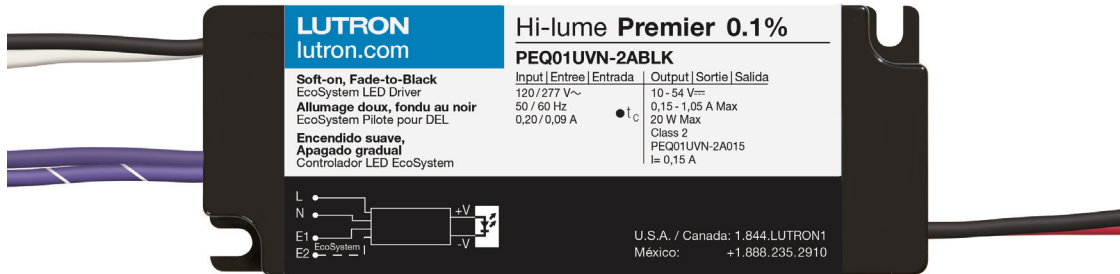

V-case type

PEQ01UVN - A

**LED Load Output Range: Class 2 Constant Current**  
(see the following pages for more detail)

- 2: 20 W Max, 0.15–1.05 A, 10–54 V<sup>==</sup>\*

**Current Level (for Constant-Current)**

- 015 = 0.15 A

**Option 1:** Order a driver configured by Lutron to a desired output current.

**Example:** PEQ01UVN-2A040 has been pre-configured at Lutron to an output of 0.40 A. Refer to the example above.

- 105 = 1.05 A

**Option 2:** Order a QwikFig compatible driver.

**Example:** PEQ01UVN-2ABLK (0.15 – 1.05 A)\*

- BLK = QwikFig compatible bulk

**Note:** Default set to minimum output current for the respective **LED Load Output Range**.

Example: PEQ01UVN-2A040

- 0.40 A
- Hi-lume Premier 0.1%
- 4–20 W\*\*
- 10–50 V<sup>==</sup>

For further assistance in selecting your model number, contact our LED Center of Excellence at **LEDs@lutron.com**

\*\* At 0.40 A, maximum voltage of 50 V provides 20 W (0.40 A × 50 V = 20 W)

\* Output voltage range changes with output current and according to power limits. Check driver specifications on the following pages carefully to understand output voltage range of a particular SKU. Purchaser is responsible for electrical compatibility between LED driver and LED load.

Job Name:

Model Numbers:

Job Number:

## “2” Output Range

Driver Type	Output Voltage	Output Current	Output Power	Standards Recognition	Maximum Rated Temp. @ t <sub>c</sub> for Warranty
Constant Current Driver (Class 2)	10–54 V $\sim$	0.15–1.05 A*	20 W		80 °C

\* QwikFig compatible model number PEQ01UVN-2ABLK is configurable to any current within this range in 0.01 A increments.

### Typical Performance Specifications:

Parameter	Value	Test Conditions
Input Current	0.2 A	V <sub>i</sub> = 120 V $\sim$ , t <sub>a</sub> = 25 °C, I <sub>o</sub> = 0.40 A, V <sub>o</sub> = 50 V $\sim$ , Maximum Light Output PEQ01UVN-2A040
Power Factor	0.95	
Total Harmonic Distortion (THD)	15%	
Driver Efficiency	85%	

Load Compatibility

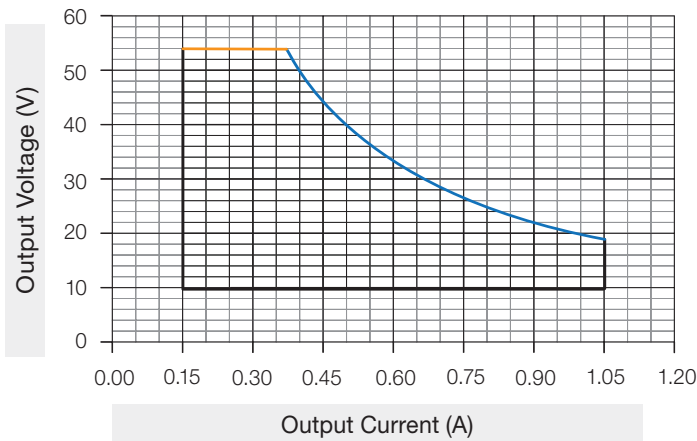

Key: — Constant 20 W output — Constant 54 V output

Typical Efficiency vs. Output Current

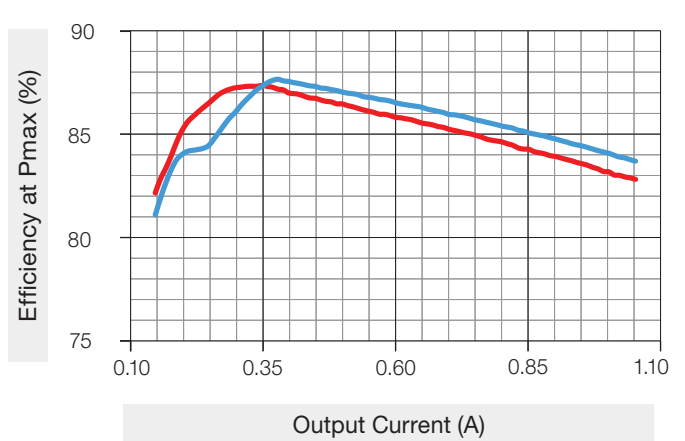

Key: — 120 V $\sim$  — 277 V $\sim$

Typical THD vs. Output Power

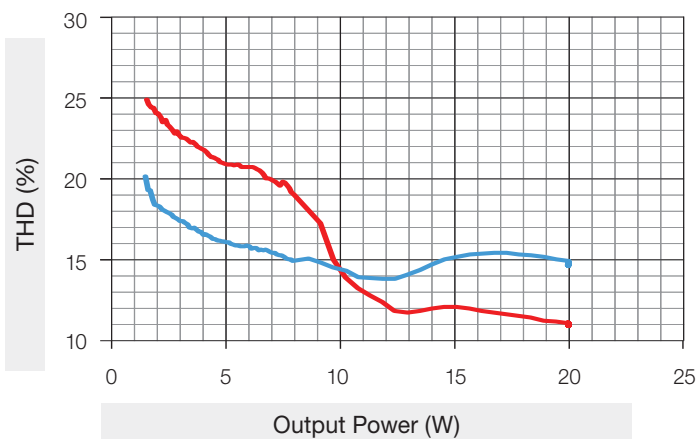

Key: — 120 V $\sim$  — 277 V $\sim$

Typical Power Factor vs. Output Power

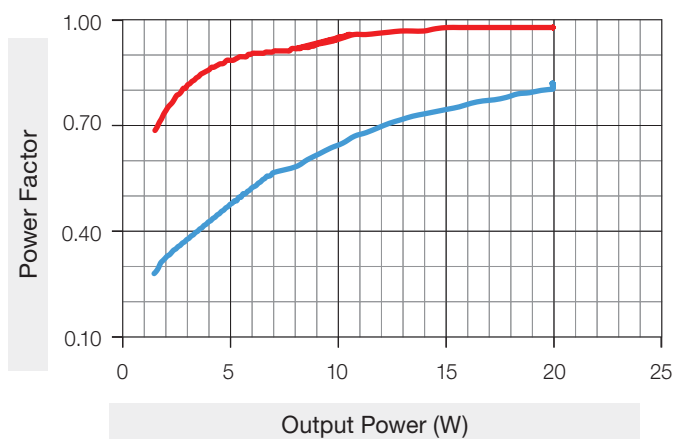

Key: — 120 V $\sim$  — 277 V $\sim$

Job Name:	Model Numbers:
Job Number:	

## “2” Output Range (continued)

Model number* PEQ01UVN-	Rated Output Current (A)	Compatible Load Voltage (V)		Typical Performance at Minimum Compatible Load Voltage			Typical Performance at Maximum Compatible Load Voltage		
		Minimum	Maximum	Power Factor at 120 V~/277 V~	THD at 120 V~/277 V~	Efficiency at 120 V~/277 V~	Power Factor at 120 V~/277 V~	THD at 120 V~/277 V~	Efficiency at 120 V~/277 V~
-2A015	0.15	10.0	54.0	0.68/0.28	25%/20%	58%/40%	0.92/0.58	21%/15%	81%/81%
-2A016	0.16	10.0	54.0	0.69/0.28	25%/19%	60%/41%	0.92/0.60	20%/15%	82%/81%
-2A017	0.17	10.0	54.0	0.71/0.29	24%/19%	61%/42%	0.93/0.62	17%/15%	83%/82%
-2A018	0.18	10.0	54.0	0.72/0.31	24%/19%	62%/42%	0.94/0.63	15%/15%	83%/83%
-2A019	0.19	10.0	54.0	0.73/0.31	24%/18%	63%/43%	0.95/0.65	14%/14%	84%/83%
-2A020	0.20	10.0	54.0	0.74/0.32	24%/18%	64%/45%	0.96/0.67	13%/14%	85%/83%
-2A021	0.21	10.0	54.0	0.75/0.33	24%/18%	65%/46%	0.96/0.68	13%/14%	85%/84%
-2A022	0.22	10.0	54.0	0.76/0.33	24%/18%	66%/47%	0.96/0.69	12%/14%	85%/84%
-2A023	0.23	10.0	54.0	0.76/0.34	24%/18%	66%/48%	0.96/0.70	12%/14%	86%/84%
-2A024	0.24	10.0	54.0	0.77/0.34	23%/18%	67%/49%	0.97/0.71	12%/14%	86%/84%
-2A025	0.25	10.0	54.0	0.78/0.35	23%/18%	68%/50%	0.97/0.72	12%/14%	86%/84%
-2A026	0.26	10.0	54.0	0.79/0.35	23%/18%	68%/51%	0.97/0.73	12%/15%	86%/84%
-2A027	0.27	10.0	54.0	0.79/0.36	23%/18%	69%/52%	0.97/0.74	12%/15%	86%/85%
-2A028	0.28	10.0	54.0	0.80/0.36	23%/18%	69%/53%	0.98/0.74	12%/15%	87%/85%
-2A029	0.29	10.0	54.0	0.80/0.37	23%/18%	70%/54%	0.98/0.75	12%/15%	87%/85%
-2A030	0.30	10.0	54.0	0.81/0.37	23%/17%	70%/55%	0.98/0.76	12%/15%	87%/85%
-2A031	0.31	10.0	54.0	0.82/0.38	23%/17%	71%/56%	0.98/0.77	12%/15%	87%/86%
-2A032	0.32	10.0	54.0	0.82/0.38	23%/17%	71%/57%	0.98/0.77	12%/15%	87%/86%
-2A033	0.33	10.0	54.0	0.83/0.39	22%/17%	72%/58%	0.98/0.78	12%/15%	87%/86%
-2A034	0.34	10.0	54.0	0.83/0.39	22%/17%	72%/59%	0.98/0.79	11%/15%	87%/87%
-2A035	0.35	10.0	54.0	0.84/0.40	22%/17%	72%/60%	0.98/0.79	11%/15%	87%/87%
-2A036	0.36	10.0	54.0	0.84/0.40	22%/17%	72%/60%	0.98/0.80	11%/15%	87%/87%
-2A037	0.37	10.0	54.0	0.85/0.41	22%/17%	73%/61%	0.98/0.80	11%/15%	87%/87%
-2A038	0.38	10.0	52.6	0.85/0.41	22%/17%	73%/62%	0.98/0.80	11%/15%	87%/87%
-2A039	0.39	10.0	51.3	0.85/0.42	22%/17%	73%/63%	0.98/0.80	11%/15%	87%/87%
-2A040	0.40	10.0	50.0	0.86/0.42	22%/17%	74%/63%	0.98/0.80	11%/15%	86%/87%
-2A041	0.41	10.0	48.8	0.86/0.43	22%/17%	74%/64%	0.98/0.80	11%/15%	86%/87%
-2A042	0.42	10.0	47.6	0.86/0.43	22%/16%	74%/65%	0.98/0.80	11%/15%	86%/87%
-2A043	0.43	10.0	46.5	0.87/0.44	21%/16%	74%/65%	0.98/0.81	11%/15%	86%/87%
-2A044	0.44	10.0	45.5	0.87/0.44	21%/16%	74%/66%	0.98/0.81	11%/15%	86%/87%

\* See **How to Build a Model Number, V-Case Type** on page 6 for a sample model number.

Job Name:	Model Numbers:
Job Number:	



“2” Output Range (continued)

Model number* PEQ01UVN-	Rated Output Current (A)	Compatible Load Voltage (V)		Typical Performance at Minimum Compatible Load Voltage			Typical Performance at Maximum Compatible Load Voltage		
		Minimum	Maximum	Power Factor at 120 V~/277 V~	THD at 120 V~/277 V~	Efficiency at 120 V~/277 V~	Power Factor at 120 V~/277 V~	THD at 120 V~/277 V~	Efficiency at 120 V~/277 V~
-2A045	0.45	10.0	44.4	0.87/0.45	21%/16%	75%/66%	0.98/0.81	11%/15%	86%/87%
-2A046	0.46	10.0	43.5	0.87/0.45	21%/16%	75%/67%	0.98/0.81	11%/15%	86%/87%
-2A047	0.47	10.0	42.6	0.88/0.46	21%/16%	75%/67%	0.98/0.81	11%/15%	86%/87%
-2A048	0.48	10.0	41.7	0.88/0.46	21%/16%	75%/68%	0.98/0.81	11%/15%	86%/87%
-2A049	0.49	10.0	40.8	0.88/0.47	21%/16%	75%/68%	0.98/0.81	11%/15%	86%/87%
-2A050	0.50	10.0	40.0	0.88/0.47	21%/16%	76%/69%	0.98/0.81	11%/15%	86%/86%
-2A051	0.51	10.0	39.2	0.88/0.48	21%/16%	76%/69%	0.98/0.81	11%/15%	86%/86%
-2A052	0.52	10.0	38.5	0.89/0.48	21%/16%	76%/69%	0.98/0.81	11%/15%	86%/86%
-2A053	0.53	10.0	37.7	0.89/0.48	21%/16%	76%/70%	0.98/0.81	11%/15%	86%/86%
-2A054	0.54	10.0	37.0	0.89/0.49	21%/16%	76%/70%	0.98/0.81	11%/15%	86%/86%
-2A055	0.55	10.0	36.4	0.89/0.49	21%/16%	76%/71%	0.98/0.81	11%/15%	86%/86%
-2A056	0.56	10.0	35.7	0.89/0.50	21%/16%	76%/71%	0.98/0.81	11%/15%	85%/86%
-2A057	0.57	10.0	35.1	0.89/0.50	21%/16%	76%/71%	0.98/0.81	11%/15%	85%/86%
-2A058	0.58	10.0	34.5	0.90/0.51	21%/16%	76%/71%	0.98/0.81	11%/15%	85%/86%
-2A059	0.59	10.0	33.9	0.90/0.51	21%/16%	76%/72%	0.98/0.81	11%/15%	85%/86%
-2A060	0.60	10.0	33.3	0.90/0.52	21%/16%	76%/72%	0.98/0.81	11%/15%	85%/86%
-2A061	0.61	10.0	32.8	0.90/0.52	21%/16%	76%/72%	0.98/0.81	11%/15%	85%/86%
-2A062	0.62	10.0	32.3	0.90/0.53	21%/16%	76%/72%	0.98/0.81	11%/15%	85%/86%
-2A063	0.63	10.0	31.7	0.90/0.53	21%/16%	76%/73%	0.98/0.81	11%/15%	85%/86%
-2A064	0.64	10.0	31.3	0.90/0.54	21%/16%	76%/73%	0.98/0.81	11%/15%	85%/86%
-2A065	0.65	10.0	30.8	0.90/0.54	20%/16%	76%/73%	0.98/0.81	11%/15%	85%/86%
-2A066	0.66	10.0	30.3	0.91/0.55	20%/16%	76%/73%	0.98/0.81	11%/15%	85%/86%
-2A067	0.67	10.0	29.9	0.91/0.55	20%/16%	76%/73%	0.98/0.81	11%/15%	85%/86%
-2A068	0.68	10.0	29.4	0.91/0.55	20%/16%	76%/74%	0.98/0.81	11%/15%	85%/86%
-2A069	0.69	10.0	29.0	0.91/0.56	20%/15%	76%/74%	0.98/0.81	11%/15%	85%/85%
-2A070	0.70	10.0	28.6	0.91/0.56	20%/15%	76%/74%	0.98/0.81	11%/15%	85%/85%
-2A071	0.71	10.0	28.2	0.91/0.57	20%/15%	76%/74%	0.98/0.81	11%/15%	85%/85%
-2A072	0.72	10.0	27.8	0.91/0.57	20%/15%	76%/74%	0.98/0.81	11%/15%	85%/85%
-2A073	0.73	10.0	27.4	0.91/0.58	20%/15%	76%/74%	0.98/0.81	11%/15%	84%/85%
-2A074	0.74	10.0	27.0	0.91/0.58	20%/15%	76%/74%	0.98/0.81	11%/15%	84%/85%

\* See How to Build a Model Number, V-Case Type on page 6 for a sample model number.

Job Name:	Model Numbers:
Job Number:	

“2” Output Range (continued)

Model number* PEQ01UVN-	Rated Output Current (A)	Compatible Load Voltage (V)		Typical Performance at Minimum Compatible Load Voltage			Typical Performance at Maximum Compatible Load Voltage		
		Minimum	Maximum	Power Factor at 120 V~/277 V~	THD at 120 V~/277 V~	Efficiency at 120 V~/277 V~	Power Factor at 120 V~/277 V~	THD at 120 V~/277 V~	Efficiency at 120 V~/277 V~
-2A075	0.75	10.0	26.7	0.91/0.58	20%/15%	76%/74%	0.98/0.81	11%/15%	84%/85%
-2A076	0.76	10.0	26.3	0.91/0.59	20%/15%	76%/75%	0.98/0.81	11%/15%	84%/85%
-2A077	0.77	10.0	26.0	0.91/0.59	19%/15%	76%/75%	0.98/0.81	11%/15%	84%/85%
-2A078	0.78	10.0	25.6	0.92/0.60	19%/15%	76%/75%	0.98/0.81	11%/15%	84%/85%
-2A079	0.79	10.0	25.3	0.92/0.60	19%/15%	76%/75%	0.98/0.81	11%/15%	84%/85%
-2A080	0.80	10.0	25.0	0.92/0.60	19%/15%	76%/75%	0.98/0.81	11%/15%	84%/85%
-2A081	0.81	10.0	24.7	0.92/0.61	19%/15%	76%/75%	0.98/0.81	11%/15%	84%/85%
-2A082	0.82	10.0	24.4	0.92/0.61	18%/15%	76%/75%	0.98/0.81	11%/15%	84%/85%
-2A083	0.83	10.0	24.1	0.92/0.61	18%/15%	76%/75%	0.98/0.81	11%/15%	84%/85%
-2A084	0.84	10.0	23.8	0.92/0.62	18%/15%	76%/75%	0.98/0.81	11%/15%	84%/85%
-2A085	0.85	10.0	23.5	0.92/0.62	18%/15%	77%/75%	0.98/0.81	11%/15%	84%/85%
-2A086	0.86	10.0	23.3	0.92/0.63	18%/14%	77%/76%	0.98/0.81	11%/15%	84%/84%
-2A087	0.87	10.0	23.0	0.92/0.63	17%/14%	77%/76%	0.98/0.81	11%/15%	84%/84%
-2A088	0.88	10.0	22.7	0.92/0.63	17%/14%	77%/76%	0.98/0.81	11%/15%	83%/84%
-2A089	0.89	10.0	22.5	0.93/0.64	17%/14%	77%/76%	0.98/0.81	11%/15%	83%/84%
-2A090	0.90	10.0	22.2	0.93/0.64	16%/14%	77%/76%	0.98/0.81	11%/15%	83%/84%
-2A091	0.91	10.0	22.0	0.93/0.64	16%/14%	77%/76%	0.98/0.81	11%/15%	83%/84%
-2A092	0.92	10.0	21.7	0.93/0.65	15%/14%	77%/76%	0.98/0.81	11%/15%	83%/84%
-2A093	0.93	10.0	21.5	0.94/0.65	15%/14%	77%/76%	0.98/0.81	11%/15%	83%/84%
-2A094	0.94	10.0	21.3	0.94/0.65	15%/14%	77%/76%	0.98/0.81	11%/15%	83%/84%
-2A095	0.95	10.0	21.1	0.94/0.66	14%/14%	77%/76%	0.98/0.81	11%/15%	83%/84%
-2A096	0.96	10.0	20.8	0.94/0.66	14%/14%	77%/76%	0.98/0.82	11%/15%	83%/84%
-2A097	0.97	10.0	20.6	0.94/0.66	14%/14%	77%/76%	0.98/0.82	11%/15%	83%/84%
-2A098	0.98	10.0	20.4	0.94/0.67	13%/14%	77%/76%	0.98/0.82	11%/15%	83%/84%
-2A099	0.99	10.0	20.2	0.95/0.67	13%/14%	77%/76%	0.98/0.82	11%/15%	83%/84%
-2A100	1.00	10.0	20.0	0.95/0.67	13%/14%	77%/76%	0.98/0.82	11%/15%	83%/84%
-2A101	1.01	10.0	19.8	0.95/0.67	13%/14%	77%/76%	0.98/0.82	11%/15%	82%/83%
-2A102	1.02	10.0	19.6	0.95/0.68	12%/14%	77%/76%	0.98/0.82	11%/15%	82%/83%
-2A103	1.03	10.0	19.4	0.95/0.68	12%/14%	77%/76%	0.98/0.82	11%/15%	82%/83%
-2A104	1.04	10.0	19.2	0.96/0.68	12%/14%	77%/76%	0.98/0.82	11%/15%	82%/83%
-2A105	1.05	10.0	19.0	0.96/0.68	11%/14%	77%/76%	0.98/0.82	11%/15%	82%/83%

\* See How to Build a Model Number, V-Case Type on page 6 for a sample model number.

Job Name:	Model Numbers:
Job Number:	

### Outer Dimensions

All measurements shown as: in (mm)

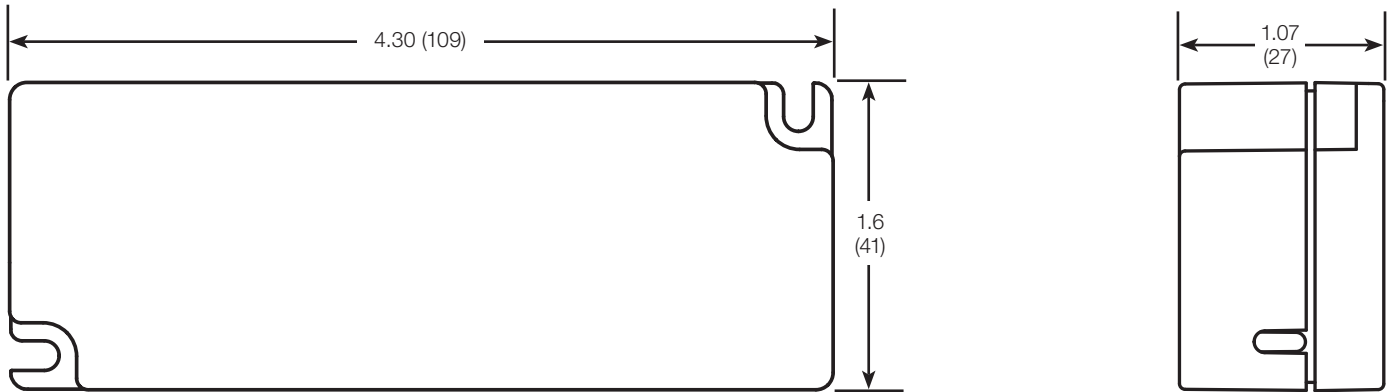

### Mounting

All measurements shown as: in (mm)

Accommodates #6 screws for mounting. Ensure that the driver is fully secured to the mounting surface. Do not clamp with more than 8 in-lb (0.9 N•m) of torque.

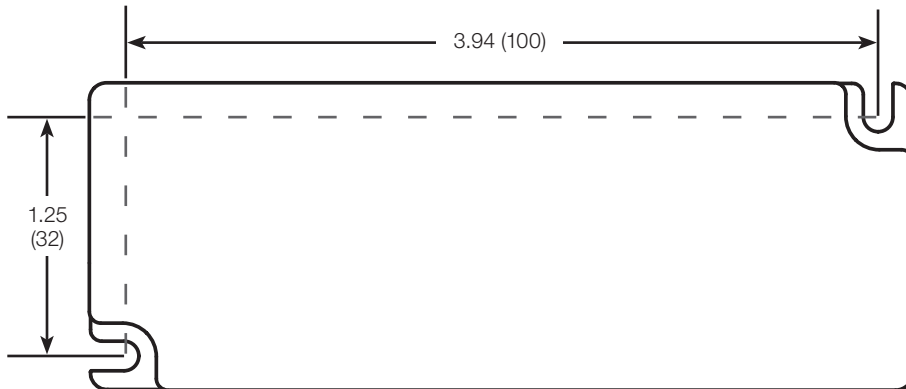

Job Name:	Model Numbers:
Job Number:	

### Wiring Gauges

Wire colors shown correspond to wires on driver.

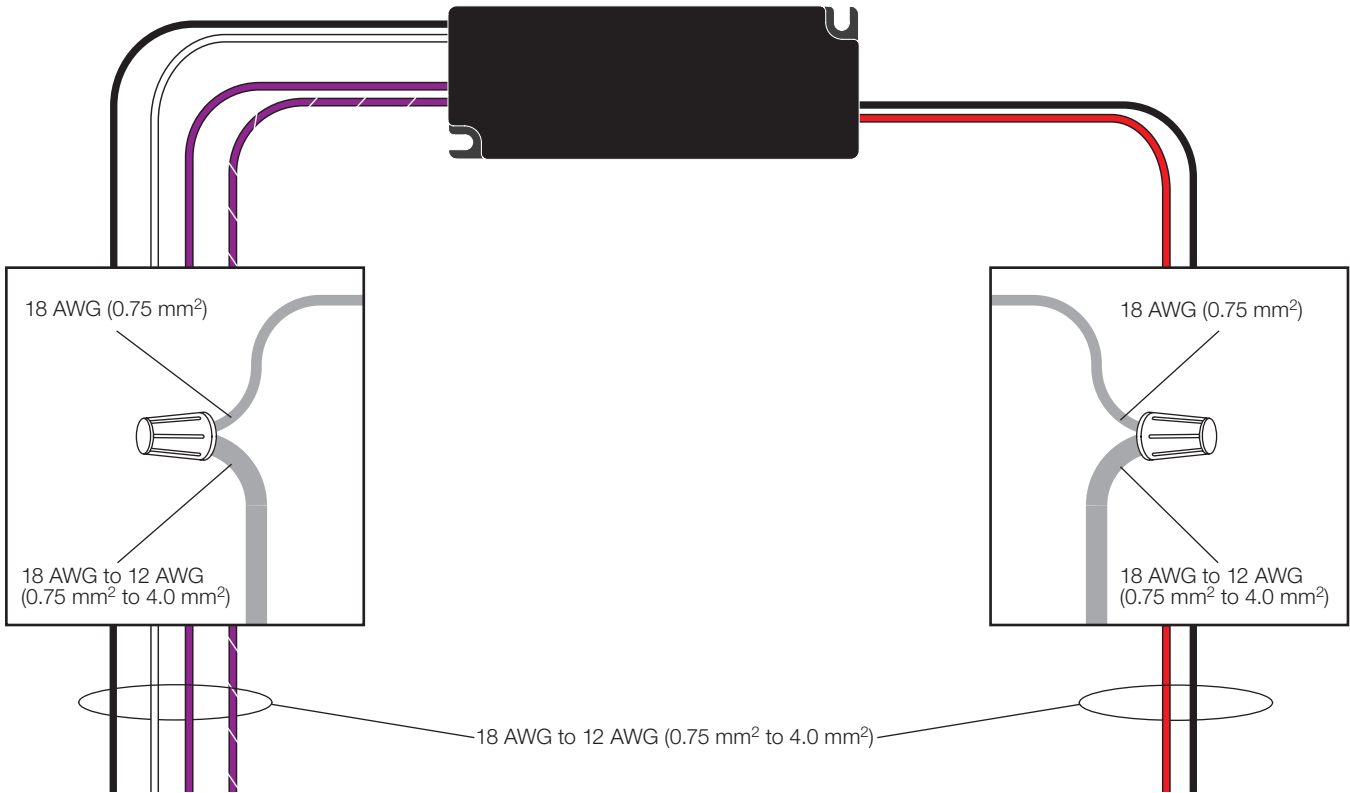

### Wiring for EcoSystem Digital Control\*

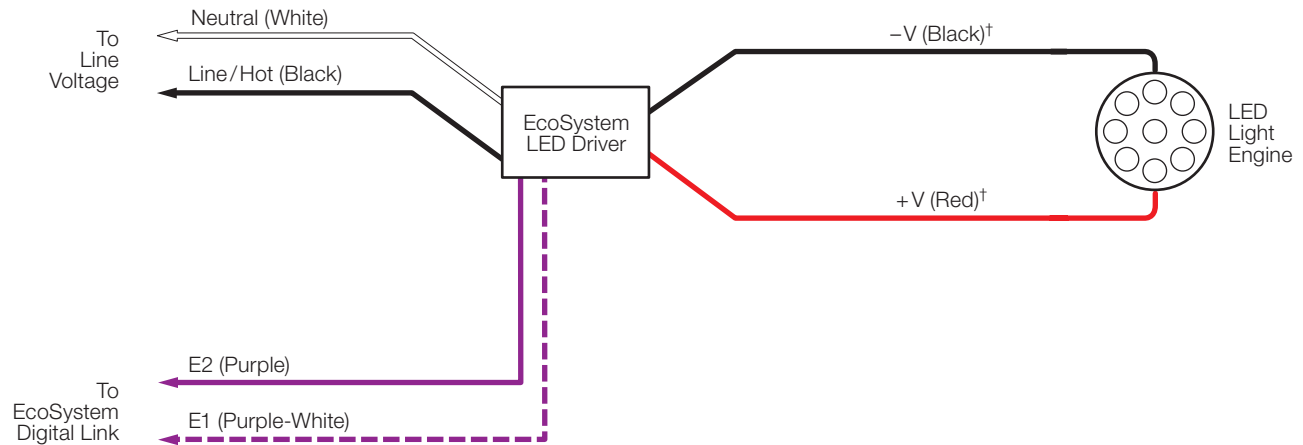

\* Refer to Lutron Application note #142 (048162), "EcoSystem Bus Class 1 and Class 2 listing" at [www.lutron.com](http://www.lutron.com) for more information on wiring options.

† For maximum driver-to-LED light engine wire length, see charts in the **Driver Wiring and Mounting** section on page 2.

Job Name:	Model Numbers:
Job Number:	

## Compatible Controls: Lutron EcoSystem Digital Controls

Guaranteed performance specifications with the controls listed in the chart below.

For assistance selecting controls, contact our LED Center of Excellence at **1.877.346.5338** or **LEDs@lutron.com**

Lutron EcoSystem Compatible Controls	Part Number		Drivers per Control		
	120 V~	277 V~	EcoSystem Loops per Control	Drivers per EcoSystem Loop	Maximum Drivers per Control
PowPak Dimming Modules	RMJ-ECO32-DV-B		1	32	32
	FCJ/FCJS-ECO <sup>1</sup>		1	3	3
Energi Savr Node	QSN-1ECO-S	N/A	1	64	64
	QSN-2ECO-S		2	64	128
GRAFIK Eye QS / HomeWorks QS control unit	QSGRJ-_E (wireless) QSGR-_E	N/A	1	64	64
Quantum Hub	QP2-__2C	N/A	2	64	128
	QP2-__4C		4	64	256
	QP2-__6C		6	64	384
	QP2-__8C		8	64	512

<sup>1</sup> All devices connected to one FCJ/FCJS-ECO will be controlled together. Devices will dim to the same level as the result of a control command. For more detail on adjusting low-end light level refer to Application Note #556 (048556) at [www.lutron.com](http://www.lutron.com)

Job Name:	Model Numbers:
Job Number:	

## EcoSystem Wiring

### EcoSystem Digital Link Overview

- The EcoSystem Digital Link wiring (E1 and E2) connects the digital ballasts and drivers together to form a lighting control system.
- E1 and E2 (EcoSystem digital link wires) are polarity-insensitive and can be wired in any topology (e.g., T-tap and daisy-chain).
- Power is supplied to the EcoSystem Digital Link from the control system.

### EcoSystem Digital Link Wiring

- Make sure that the supply breaker to the drivers and EcoSystem Digital Link Supply is OFF when wiring.
- Connect the two conductors to the two driver terminals E1 and E2 as shown.
- Using two different colors for E1 and E2 will reduce confusion when wiring several drivers together.
- The EcoSystem Digital Link may be wired Class 1 or Class 2. Consult applicable electrical codes for proper wiring practices. Refer to Lutron Application Note #142 (P/N 048162), "EcoSystem Bus Class 1 and Class 2 listing" at [www.lutron.com](http://www.lutron.com) for more information on wiring options.
- For emergency wiring, please refer to Lutron Application Note #106 (P/N 048106) at [www.lutron.com](http://www.lutron.com)

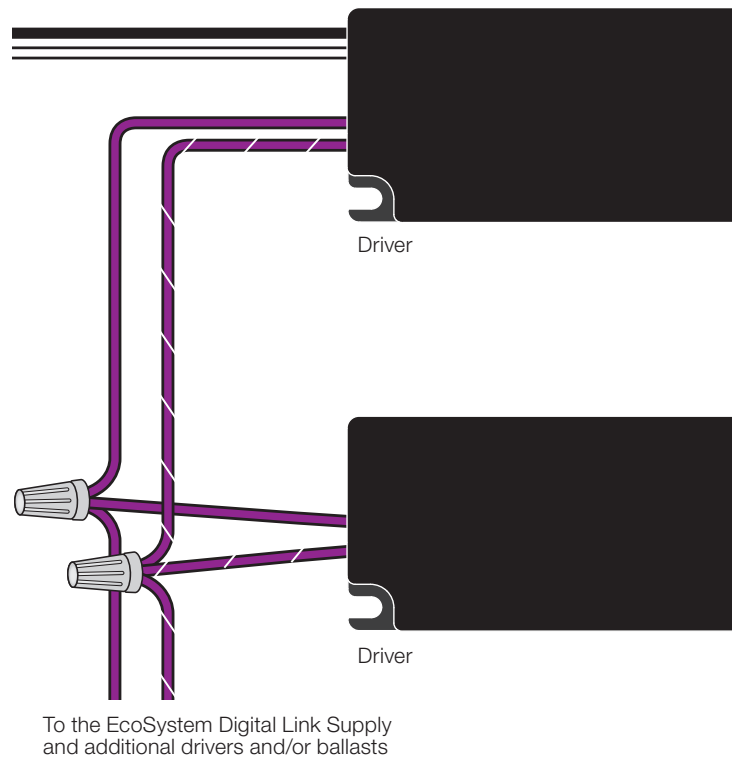

### Notes

- The EcoSystem Digital Link Supply does not have to be located at the end of the Digital Link.
- Both wires of the EcoSystem link are included in maximum digital lead length.
- EcoSystem Digital Link length is limited by the wire gauge used for E1 and E2 as follows:

Wire Gauge	Digital Link Length (max)
12 AWG	2200 ft
14 AWG	1400 ft
16 AWG	900 ft
18 AWG	550 ft

Wire Size	Digital Link Length (max)
4.0 mm <sup>2</sup>	828 m
2.5 mm <sup>2</sup>	517 m
1.5 mm <sup>2</sup>	310 m
1.0 mm <sup>2</sup>	207 m
0.75 mm <sup>2</sup>	155 m

Job Name:

Model Numbers:

Job Number:

## Service

### Warranty

For warranty information, please visit [www.lutron.com/driverwarranty](http://www.lutron.com/driverwarranty)

### Replacement Parts

When ordering Lutron replacement parts, please provide the full model number. Consult Lutron if you have any questions.

### Further Information

For further information, please visit us at [www.lutron.com/hilume1softbled](http://www.lutron.com/hilume1softbled) or contact our LED Control Center of Excellence at 1.877.346.5338 or [LEDs@lutron.com](mailto:LEDs@lutron.com)

 Lutron, Lutron, EcoSystem, Energi Savr Node, GRAFIK Eye, Hi-lume, HomeWorks, PowPak, Quantum, QwikFig, Soft-on, Fade-to-Black, and Vive are trademarks or registered trademarks of Lutron Electronics Co., Inc. in the U.S. and other countries.

All product names, logos, and brands are property of their respective owners.

## LUTRON SPECIFICATION SUBMITTAL

Page

<b>Job Name:</b>	<b>Model Numbers:</b>
<b>Job Number:</b>	