

Serena™ RF Cellular Shade

Motorized shade with wireless radio frequency (RF) control
Installation Guide (please read before installing)

English

Step 1: Review included components:

Before you begin, open the box and make sure you have all the necessary parts: the shade, mounting brackets, and screws.

You will also need a cordless drill, a 3/32 inch drill bit, a #2 Phillips bit, a pencil, a tape measure, and 4 or 6 "D" alkaline batteries (depending on the shade's size) if you purchased a battery-powered shade.

Included:



Tools required:

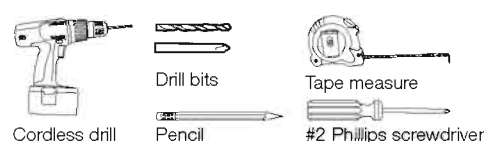

Batteries:



Other Power Options:



Step 2: Installing Mounting Brackets

Your shade was manufactured according to the mounting option you chose when ordering your shade. Make sure you follow the appropriate mounting instructions:
Opt. 1 inside mount, **Opt. 2** outside mount on trim, or **Opt. 3** outside mount above trim.

Option 1: Inside Mount: Installing Mounting Brackets

1.1 Hold the shade up to the window to make sure it's the correct size.



1.2 Use a pencil to mark where you will need to install the mounting brackets. If you're installing an inside mount shade, align the brackets with the front edge of the window trim, 2 inches in from each side of the window.

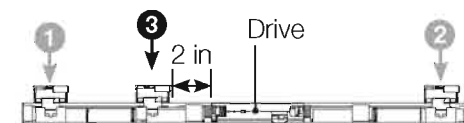
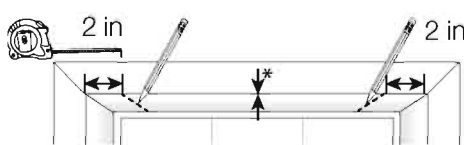

Top view of shade wider than 45 inches or 48 inches

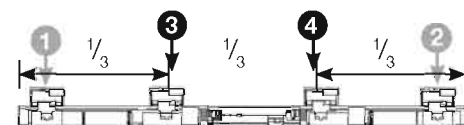

Top view of shade wider than 72 inches

*NOTE: Shades wider than 45 inches (vinyl headrail) or 48 inches (aluminum headrail) will need a third bracket (3). Install this bracket 2 inches to the left of the drive (the box in the middle of the headrail).

If the shade is wider than 72 inches, you will need to install a third (3) and a fourth bracket (4). Install each of these one-third of the way in from the outer brackets.

1.3 Using the brackets as a guide, mark hole locations and then pre-drill holes for the screws.

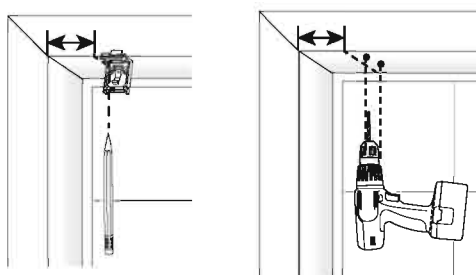

1.4 Install the mounting brackets, using the provided screws. Place each bracket flush against the front of the window frame and, using the cordless drill, drive each screw through the holes in the top of the bracket.

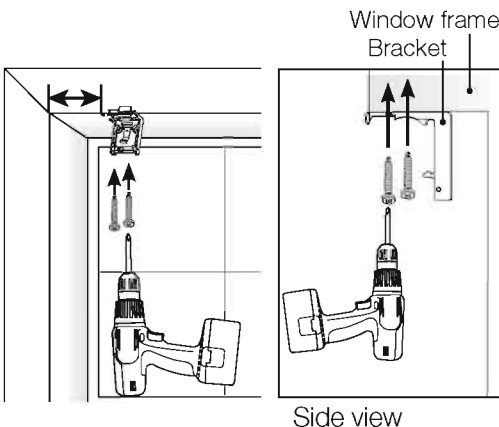

Important:

Make sure the brackets are aligned with each other. (If not, the shade may not operate properly.)

1.5 For the best RF range, reposition the antenna holder. Unsnap the antenna holder from the headrail.

Antenna holder as shipped

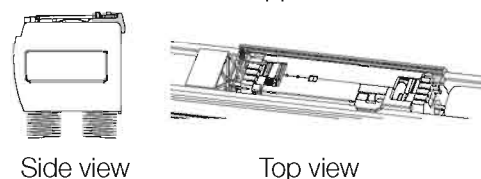

Move it out to the operating position behind the headrail, and snap it into place.

Antenna holder repositioned

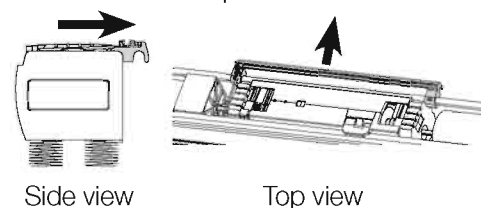

1.6 Install the shade in the brackets. Holding the shade in both hands, tilt the top of the shade slightly away from you and hook the front edge into the brackets behind the battery release tabs. Then gently tilt the shade down and press the bottom of the headrail until you hear it click into place.

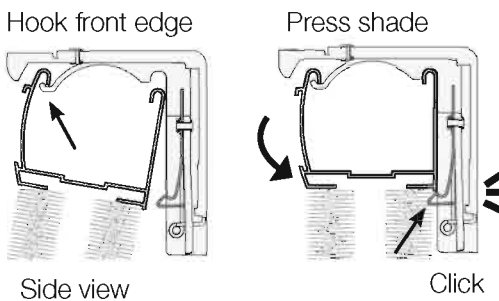

Important:

Be sure not to catch any fabric cells in the brackets.

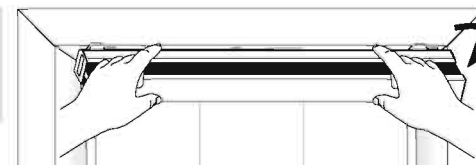

Option 2: Outside Mount On Trim: Install Mounting Brackets

2.1 Hold the shade up to the window to make sure it's the correct size. Center the shade and use a pencil to mark the trim at each end of the shade.



2.2 Then use a pencil to mark where you'll need to install the mounting brackets, 2 inches in from the marks you made in step 2.1.

*NOTE: Shades wider than 45 inches (vinyl headrail) or 48 inches (aluminum headrail) will need a third bracket (3). Install this bracket 2 inches to the left of the drive (the box in the middle of the headrail).

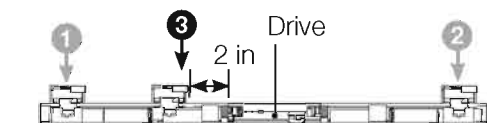
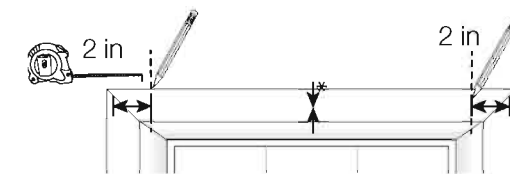

Top view of shade wider than 45 inches or 48 inches

If the shade is wider than 72 inches, you will need to install a third (3) and a fourth bracket (4). Install each of these one-third of the way in from the outer brackets.

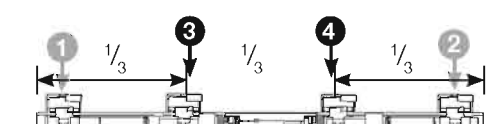

Top view of shade wider than 72 inches

2.3 Align the top of the brackets with the top of the trim. Using the brackets as a guide, mark hole locations and then pre-drill holes for the screws.

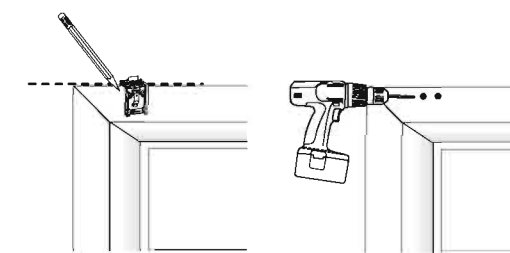

2.4 Install the mounting brackets using the provided screws. Place each bracket flush against the trim (using spacers behind brackets if needed) and using the cordless drill, drive each screw through the holes in the bracket.

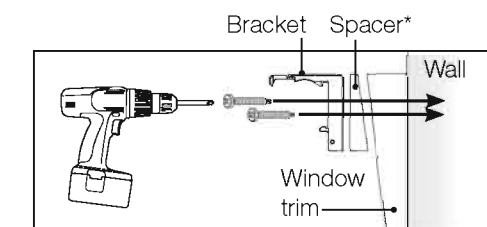
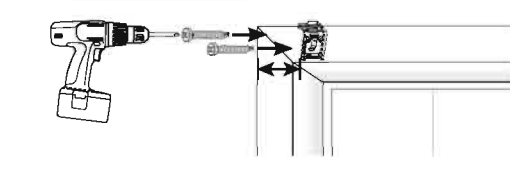

Side view *Optional (not included)

*NOTE: If window trim is angled, or not level vertically, place an angled spacer (not included) behind each bracket. Ensure that the shade is level before placing the bracket flush against the trim. Pre-drill a hole through the spacer as well.

2.5 Refer to steps 1.5 and 1.6 to extend the antenna holder and install the shade in the brackets.

Important:

Make sure the brackets are aligned with each other. (If not, the shade may not operate properly.)

Lutron Electronics Co., Inc. SHADING SOLUTIONS – Eight Year Limited Warranty

WARRANTY SCOPE

This limited warranty ("Warranty") covers the Lutron® supplied (a) Serena™ Shades, (b) Sivoia® Shade Systems ("Sivoia Shade Systems"), (c) manual shade system and (d) alternating current or a/c shade system (each of the foregoing being a "System"). Customer acknowledges and agrees that use of the System constitutes acceptance of all terms and conditions of this Warranty.

LIMITED WARRANTY

Subject to the exclusions and restrictions described below, Lutron warrants that each System will be free from manufacturing defects from the date of shipment by Lutron for a period of (a) one year as to the wall controls, interfaces and system accessories of the Shade System ("External Components") and (b) eight years as to the other Systems and the electronic drive unit, shade fabric and shade hardware of the Shade System. If any manufacturing defect exists in the External Components, so long as Customer promptly notifies Lutron of the defect within the one year warranty period and, if requested by Lutron, returns the defective part(s), Lutron will, at its option, either repair the defective part(s) or provide comparable replacement part(s). If any manufacturing defect exists in any of the components of a System other than the External Components, so long as Customer promptly notifies Lutron of the defect within the eight year warranty period and, if requested by Lutron, returns the defective part(s), Lutron will, at its option, either repair the defective part(s) or issue a credit to the Customer against the purchase price of comparable replacement part(s) purchased from Lutron as provided below:

Number of years from date of shipment	Percentage of cost of replacement parts credited by Lutron
Up to 5	100%
More than 5 but not more than 8	50%
More than 8	0%

Replacement parts for the System provided by Lutron or, at its sole discretion, an approved vendor may be new, used, repaired, reconditioned, and/or made by a different manufacturer.

EXCLUSIONS AND RESTRICTIONS

This Warranty will be void, and Lutron and its suppliers will have no responsibility under this Warranty, if Lutron or its representatives cannot access any components of the System to inspect, diagnose problems with or repair the System or any of its components as a result of concealment or inaccessibility of such components within a building structure.

This Warranty does not cover, and Lutron and its suppliers are not responsible for:

- Damage, malfunction or inoperability diagnosed by Lutron or a Lutron approved third party as caused by normal wear and tear, abuse, misuse, incorrect installation, neglect, accident, interference or environmental factors, such as (a) use of incorrect line voltages fuses or circuit breakers; (b) failure to install, maintain and operate the System pursuant to the operating instructions provided by Lutron and the applicable provisions of the National Electrical Code and of the Safety Standards of Underwriter's Laboratories; (c) use of incompatible devices or accessories; (d) improper or insufficient ventilation; (e) unauthorized repairs or adjustments or alterations; (f) vandalism; (g) an act of God, such as fire, lightning, flooding, tornado, earthquake, hurricane or other problems beyond Lutron's control; or (h) direct exposure to corrosive materials.
- On-site labor costs to diagnose issues with, and remove, repair, replace, adjust, reinstall and/or reprogram the System or any of its components.
- Components and equipment external to the System, such as, non-Lutron lighting and automation systems; building wiring audio-visual equipment; and non-Lutron time clocks, photosensors and motion detectors.
- The cost of repairing or replacing other property that is damaged when any System does not work properly, even if the damage was caused by the System.

THIS WARRANTY IS IN LIEU OF ALL OTHER EXPRESS WARRANTIES. ALL IMPLIED WARRANTIES, INCLUDING THE IMPLIED WARRANTIES OF MERCHANTABILITY AND OF FITNESS FOR A PARTICULAR PURPOSE, ARE LIMITED TO EIGHT YEARS FROM THE DATE OF SHIPMENT, EXCEPT THAT SUCH IMPLIED WARRANTIES ARE LIMITED TO ONE YEAR FROM THE DATE OF SHIPMENT AS TO THE EXTERNAL COMPONENTS.

NO LUTRON AGENT, EMPLOYEE OR REPRESENTATIVE HAS ANY AUTHORITY TO BIND LUTRON TO ANY AFFIRMATION, REPRESENTATION OR WARRANTY CONCERNING THE SYSTEMS. UNLESS AN AFFIRMATION, REPRESENTATION OR WARRANTY MADE BY AN AGENT, EMPLOYEE OR REPRESENTATIVE IS SPECIFICALLY INCLUDED HEREIN, OR IN STANDARD PRINTED MATERIALS PROVIDED BY LUTRON, IT DOES NOT FORM A PART OF THE BASIS OF ANY BARGAIN BETWEEN LUTRON AND CUSTOMER AND WILL NOT IN ANY WAY BE ENFORCEABLE BY CUSTOMER.

IN NO EVENT WILL LUTRON OR ANY OTHER PARTY BE LIABLE FOR EXEMPLARY, CONSEQUENTIAL, INCIDENTAL OR SPECIAL DAMAGES (INCLUDING, BUT NOT LIMITED TO DAMAGES FOR PERSONAL INJURY, FAILURE TO MEET ANY DUTY, INCLUDING OF GOOD FAITH OR REASONABLE CARE, NEGLIGENCE, OR ANY OTHER LOSS WHATSOEVER), NOR FOR ANY REPAIR WORK UNDERTAKEN WITHOUT LUTRON'S PRIOR WRITTEN CONSENT ARISING OUT OF OR IN ANY WAY RELATED TO THE INSTALLATION, DEINSTALLATION, USE OF OR INABILITY TO USE THE SYSTEM OR OTHERWISE UNDER OR IN CONNECTION WITH ANY PROVISION OF THIS WARRANTY, EVEN IN THE EVENT OF THE FAULT, TORT (INCLUDING NEGLIGENCE), STRICT LIABILITY, BREACH OF CONTRACT OR BREACH OF WARRANTY OF LUTRON OR ANY OTHER PARTY, AND EVEN IF LUTRON OR SUCH OTHER PARTY WAS ADVISED OF THE POSSIBILITY OF SUCH DAMAGES.

NOTWITHSTANDING ANY DAMAGES THAT CUSTOMER MIGHT INCUR FOR ANY REASON WHATSOEVER (INCLUDING, WITHOUT LIMITATION, ALL DIRECT DAMAGES AND ALL DAMAGES LISTED ABOVE), THE ENTIRE LIABILITY OF LUTRON AND OF ALL OTHER PARTIES UNDER THIS WARRANTY ON ANY CLAIM FOR DAMAGES ARISING OUT OF OR IN CONNECTION WITH THE MANUFACTURE, SALE, INSTALLATION, DELIVERY, USE, REPAIR, OR REPLACEMENT OF THE SYSTEM, AND CUSTOMER'S SOLE REMEDY FOR THE FOREGOING, WILL BE LIMITED TO THE AMOUNT PAID BY CUSTOMER FOR THE SYSTEM. THE FOREGOING LIMITATIONS, EXCLUSIONS AND DISCLAIMERS WILL APPLY TO THE MAXIMUM EXTENT ALLOWED BY APPLICABLE LAW, EVEN IF ANY REMEDY FAILS ITS ESSENTIAL PURPOSE.

THIS WARRANTY GIVES YOU SPECIFIC LEGAL RIGHTS. YOU MAY ALSO HAVE OTHER RIGHTS WHICH VARY FROM STATE TO STATE. SOME STATES DO NOT ALLOW LIMITATIONS ON HOW LONG AN IMPLIED WARRANTY LASTS OR THE EXCLUSION OR LIMITATION OF INCIDENTAL OR CONSEQUENTIAL DAMAGES, SO THE ABOVE LIMITATIONS OR EXCLUSIONS MAY NOT APPLY TO YOU.

WARRANTY CLAIMS, TECHNICAL ASSISTANCE AND WARRANTY INFORMATION

Contact the Lutron Technical Support Center at the numbers provided below or your local Lutron sales representative with questions concerning the installation or operation of the System or this Warranty, or to make a warranty claim. Please provide the exact model number when calling.

USA and Canada (24 hrs/7 days)
(800) 523-9466
Other countries (8 a.m. – 8 p.m. ET)
(610) 282-3800
Fax (610) 282-3090
<http://www.lutron.com>

FCC Information

Note:

This equipment has been tested and found to comply with the limits for a Class B digital device, pursuant to part 15 of the FCC rules. These limits are designed to provide reasonable protection against harmful interference in a residential installation. This equipment generates, uses and can radiate radio frequency energy and, if not installed and used in accordance with the instructions, may cause harmful interference to radio and television reception, which can be determined by turning the equipment off and on. The user is encouraged to try to correct the interference by one or more of the following measures:

- Reorient or relocate the receiving antenna.
- Increase the separation between the equipment and receiver.
- Connect the equipment into an outlet on a circuit different from that to which the receiver is connected.
- Consult the dealer or an experienced radio/TV technician for help.

Note:

Changes or modifications not expressly approved by Lutron Electronics Co. could void the user's authority to operate this equipment.
* This device complies with Part 15 of the FCC Rules.

Operation is subject to the following two conditions:

- (1) This device may not cause harmful interference and
- (2) This device must accept any interference received, including interference that may cause undesired operation. This Class B digital apparatus complies with Canadian ICES-003.

IC Information

This device complies with Industry Canada licence-exempt RSS standard(s). Operation is subject to the following two conditions:

- (1) this device may not cause interference, and
- (2) this device must accept any interference, including interference that may cause undesired operation of the device.

Lutron Technical Support

Contact Lutron Technical Support at the numbers provided below or your local Lutron sales representative with questions concerning the installation or operation of the System or this Warranty, or to make a warranty claim. Please provide the exact model number when calling.

Lutron, the Sunburst logo, Sivoia, seeTouch, RadioRA, HomeWorks, and Pico are registered trademarks of Lutron Electronics Co., Inc. Serena is a trademark of Lutron Electronics Co., Inc.

Worldwide Headquarters | USA

Lutron Electronics Co., Inc.
7200 Suter Road
Coopersburg, PA 18036-1299 USA
TEL: 1.610.282.3800
FAX: 1.610.282.3090
Technical Support: 888.445.8063
Toll Free: 1.888.LUTRON
EMAIL: shadinginfo@lutron.com
WEB: www.lutron.com/shadingsolutions

Europe Headquarters | United Kingdom

Lutron EA Ltd
6 Sovereign Close
London, E1W 3JF, UK
TEL: +44.(0)20.7702.0657
FAX: +44.(0)20.7480.6899
Technical Support: +44.(0)20.7480.6899
FREEPHONE: 0800.282.107

Asian Headquarters | Singapore

Lutron GL Ltd
15 Hoe Chiang Road
#07-03
Singapore, 089316
TEL: +65.6220.4666
FAX: +65.6220.4333
Technical Support: 800.120.4491

©11/2011 LUTRON Electronics Co., Inc.
P/N 045-353 REV. C

Removing the Shade From the Brackets

1 To completely remove the shade from its brackets, first locate the metal tab on each bracket. The tab is located where the shade fabric meets the headrail on the side closest to the window.

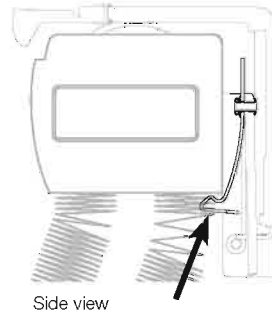

2 Insert a small flathead screwdriver through the hole in the metal tab so the tip of the screwdriver is between the headrail and tab.

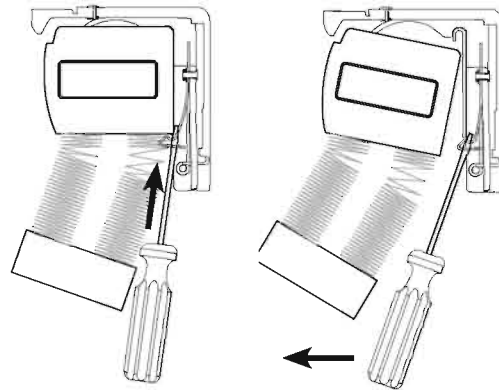

3 Pull the screwdriver toward you until the tab releases the headrail. Repeat for each bracket on the shade.

Once you have released all tabs, you can lift the shade off the brackets.

Cleaning the Fabric

1 To keep your cellular shades looking their best, regularly brush them with a feather duster or lightly vacuum them with a brush-type attachment.

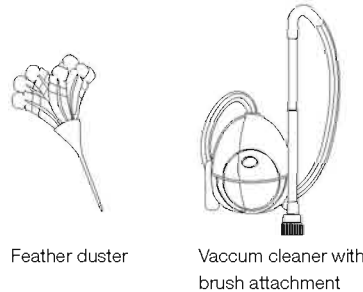

2 If your shades get a spot of dirt or a stain on them, use a clean, soft cloth and a solution of mild detergent and warm water (1 part detergent to 3 parts water) to blot or lightly rub the spot or stain.

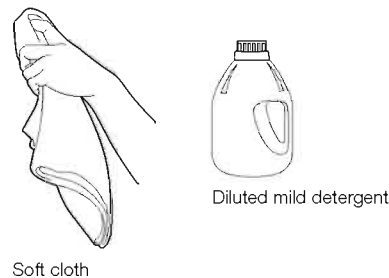

Important:

Be extra careful if you're cleaning a blackout fabric because you could permanently crease the fabric.

Also, **do not** use strong detergents or spot removers, and **do not** have your shades professionally dry cleaned.

Troubleshooting

Symptom	Solution
Shade doesn't power up	Battery powered shade: 1) Ensure batteries are installed correctly. 2) Ensure batteries are fresh.
	Wired shade: 1) Ensure the wires are properly connected to the drive. 2) Ensure the wires are properly connected to plug-in supply or panel.
Limited RF range	Ensure antenna bracket was moved into installation position
Shade powers up, but is not moving	Check the shade LED for feedback when a command is sent to the shade. If the LED blinks, contact tech support at 1.800.523.9466 to resolve the movement issue. If the LED does not give any feedback: 1) Ensure the drive is powered by pressing the button on the shade to verify it lights up green.) 2) Repeat assignment steps located in Step 4: Programming
	Leave shade in closed position to allow fabric to relax. Time required to relax may vary (up to 24 hours). Contact tech support at 888.445.8063 for instructions to walk through leveling process.
Shade isn't level	
Shade is moving slowly with red LED lit	Indicates that batteries are low and need to be replaced.
Shade fabric will not reach windowsill	Check lower limit setting. If adjusting lower limit does not fix the issue, then allow fabric to relax.
	Leave shade in closed position to allow fabric to relax. Time required to relax may vary (up to 24 hours).

Low Battery Indicator

Shade Button Blink Pattern	Description
1 red blink every 5 seconds	The shade cannot move. Batteries need to be replaced.
Red LED on while shade is moving, then off	Shade has only a few motions left. Batteries need to be replaced.
Red LED is on for 5 seconds, then off, after command is sent	Shade "heard" the button press, but cannot move. Batteries need to be replaced.

Restoring the Shade's Factory Settings

This step will remove any Pico controls assigned to the shade as well as any existing programming. It will not affect the shade's upper and lower limits.

Tap the shade button quickly three times, and hold the shade button until the button blinks green rapidly.

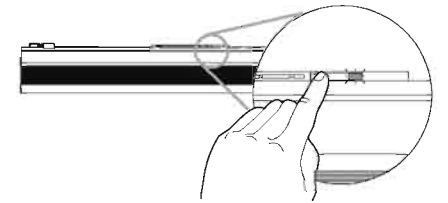



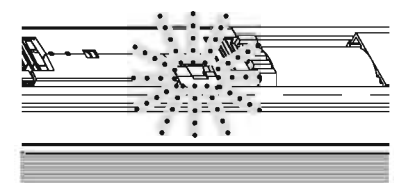







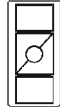
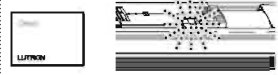



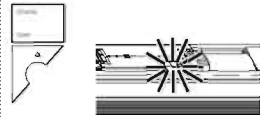

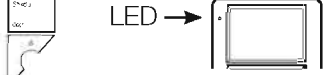





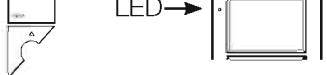

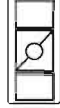
Immediately tap the shade button quickly three more times, until the shade button blinks green rapidly, then blinks red/green three times, and turns off.

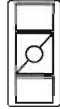

For additional troubleshooting help, visit www.serenashades.com.

If you have any questions regarding your cellular shades please call Lutron tech support at 888.445.8063. Our technical support staff are available 24 hours a day, 7 days a week.

Step 4 - Programming Your Shade

Desired action	1. Put the shade into programming mode	2. Put the control into programming mode	3. Adjust settings	4. Save settings	5. Return the control to normal operation	End Result	
1. Assign a Pico® wireless control to the shade (Must be done before the shade will work)	Tap the shade button on all shades you want assigned  Shade button illuminates green (Continue to programming in 30 seconds or less to avoid timeout)	Pico wireless control  	Hold "Close" button for about 5 seconds, until the shade button blinks and turns off.			You have assigned the control to the shade. Note: Repeat to assign more controls.	
Note: Allow 24 hours for shade fabric to relax before adjusting limits. Lower and upper limits are pre-programmed based on your window dimensions, but may need fine-tuning.							
2. Set the shade's lower limit 	Tap the shade button on the shade you want to set the lower limit on.  Shade button illuminates green (Continue to programming in 30 seconds or less to avoid timeout)	Pico wireless control  	Hold "Open" and "Raise" buttons for about 5 seconds, until the shade button blinks and remains lit.	Use the control's "Raise" and "Lower" buttons to adjust shade position to the lower limit you prefer. 	Hold "Close" button for about 5 seconds, until the shade button blinks and turns off. 	Note: This step is only necessary for a Pico with an LED. Hold "Open" and "Raise" until the LED on the Pico turns off. 	You have set the shade's lower limit.
3. Set the shade's upper limit (optional) 	Tap the shade button on the shade you want to set the upper limit on.  Shade button illuminates green (Continue to programming in 30 seconds or less to avoid timeout)	Pico wireless control  	Hold "Open" and "Raise" buttons for about 5 seconds, until the shade button blinks and remains lit.	Use the control's "Raise" and "Lower" buttons to adjust shade position to the upper limit you prefer. 	Hold "Open" button for about 5 seconds, until the shade button blinks and turns off. 	Note: This step is only necessary for a Pico with an LED. Hold "Open" and "Raise" until the LED on the Pico turns off. 	You have set the shade's upper limit.
4a. Set a favorite shade level (preset) for one shade assigned to the Pico, or multiple shades assigned to the Pico at the same level 		Pico wireless control 		Use the control's "Raise" and "Lower" buttons to adjust shade position to the level you prefer. 	Hold "Favorite" button for about 5 seconds. 		You have set a favorite preset level.
4b. Set a favorite shade level (preset) for multiple shades assigned to the Pico at different levels 		Pico wireless control 	Use the control's "Raise" and "Lower" buttons to adjust the 1st shade's position to the level you prefer. Then disconnect the shade's power by either removing a battery or unplugging the power supply. Repeat for additional shades.	  	Once shades are at preferred level, restore power to all shades, then hold "Favorite" button for about 5 seconds.  		You have set a favorite preset level.

Option 3: Outside Mount Above Trim: Installing Mounting Brackets

3.1 Hold the shade up to the window to make sure it's the correct size. Center the shade and use a pencil to mark the trim at each end of the shade.



3.2 Use a pencil to mark where you will need to install the mounting brackets, 2 inches in from the marks you made in step 3.1.

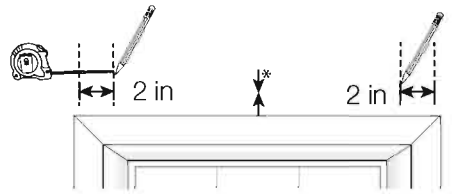

*NOTE: Shades wider than 45 inches (vinyl headrail) or 48 inches (aluminum headrail) will need a third bracket (3). Install this bracket 2 inches to the left of the drive (the box in the middle of the headrail).

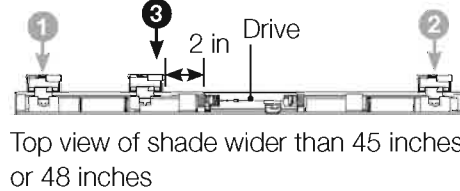

Top view of shade wider than 45 inches or 48 inches

If the shade is wider than 72 inches, you will need to install a third (3) and a fourth bracket (4). Install each of these one-third of the way in from the outer brackets.

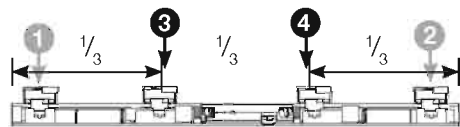

Top view of shade wider than 72 inches

3.3 After using your marks to place the brackets against the wall, align the top of the brackets with each other and mark their location, making sure they are level.



3.4 Using the brackets as a guide, mark hole locations and then pre-drill holes for the screws. Place a spacer behind each bracket (to ensure that the shade clears the window trim).

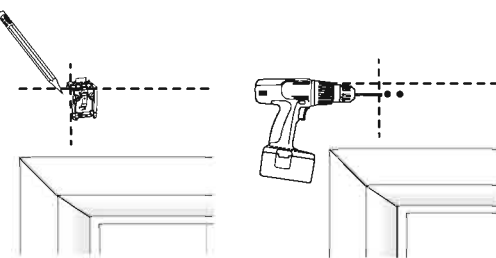

3.5 Then place the bracket flush against the spacer and the wall, aligning the holes. Drive a screw through the holes in the bracket and through the spacer.

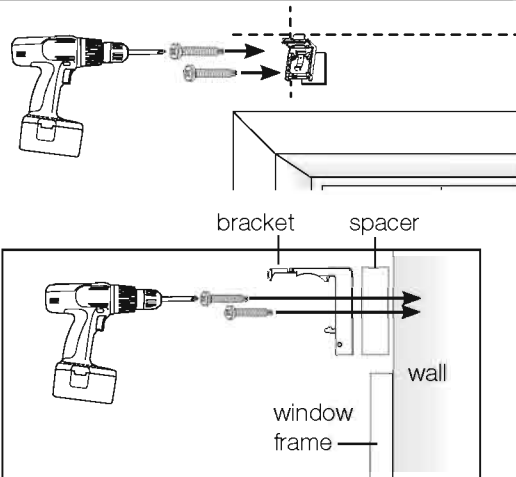

Side view

Important:

- Make sure you are screwing into wood studs.
- If you're not mounting the brackets into wood studs, you'll need to use appropriate fasteners for the mounting surface (not included).
- Make sure the brackets are aligned with each other. (If not, the shade may not operate properly.)

3.6 Refer to steps 1.5 and 1.6 to extend the antenna holder and install the shade in the brackets.

Step 3A: Installing and Replacing Batteries

If you have a battery-powered shade, installing and replacing the batteries is a snap. Sivoia® QS Wireless cellular shades use Triathlon™ power technology to achieve a typical battery life of 3 years.* Lutron recommends only alkaline batteries.

1 Press the battery release tabs (PUSH) above the headrail. The shade will tilt forward, exposing the battery trays.

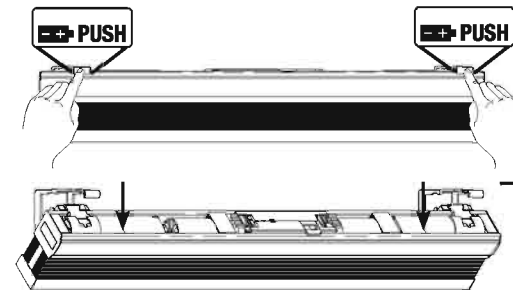

2 Install the batteries as indicated in the battery trays (so the + / - signs match). Make sure the batteries are fully inserted in the trays.

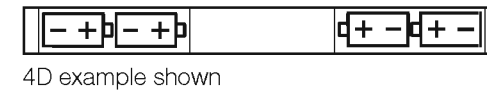

4D example shown

For best battery life, don't mix old and new batteries, use only D-size alkaline batteries, and don't mix battery types or use carbon-zinc batteries. Also, don't use rechargeable batteries.

Once all the batteries are in place, the LED indicator light will flash briefly.

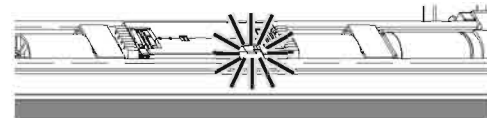

3 To replace the batteries, press the battery release tabs located above the shade headrail. The headrail will tilt forward, exposing the batteries inside of it.

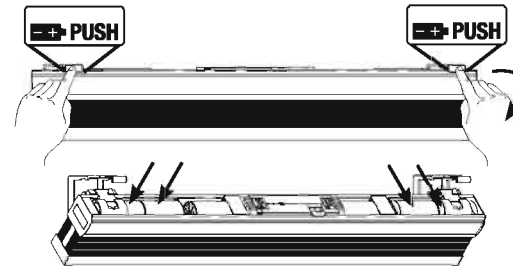

4 Remove all of the batteries from each side of the tray, beginning with the battery that's closest to the middle of the headrail. After you have taken that battery out, slide the next battery over and remove it. Now you can insert the new batteries, following steps 1 and 2 above.

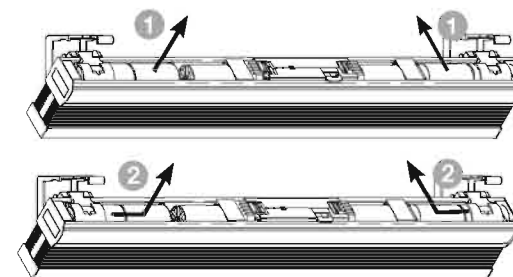

5 Grasp the headrail with both hands and tilt it back into the brackets, pressing gently until you hear a click.



Tilt shade

Press shade

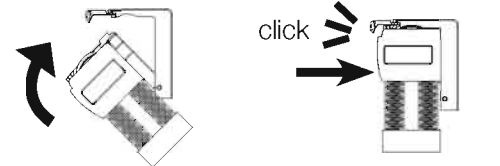

Side view

Step 3B: Attaching Power Supply

If you have a shade that uses the plug-in power supply, attaching the power supply is simple.

1 Press both battery release tabs (PUSH) above the headrail. The shade will tilt forward, exposing the power cable.

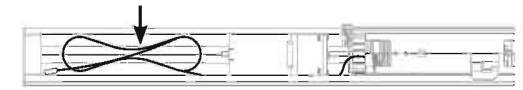

2 Uncoil the cable and plug it into the plug-in power supply.

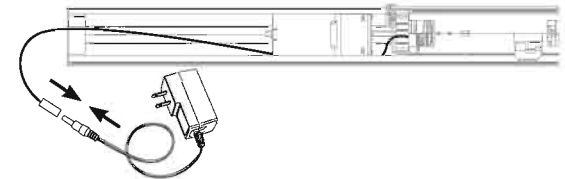

3 Grasp the headrail with both hands and tilt it back into the brackets, pressing gently until you hear a click.



Tilt shade

Press shade

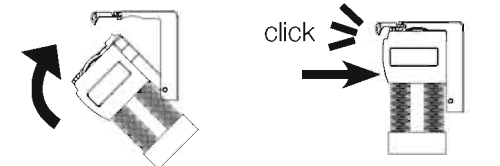

Side view

4 Plug the plug-in power supply into an outlet. Your shade is now powered!

* 3-year battery life based on 2 up and 2 down movements per day assuming a 3 ft. wide by 5 ft. tall shade using light-filtering fabric. Battery life can vary between 2 to 5 years depending on shade size and fabric selection.