

LUTRON NOTES:
 ALL DIMMING BALLASTS TO BE LUTRON ECOSYSTEM, ECOSYSTEM H-SERIES, OR H-LINE 30 TYPICAL UNLESS OTHERWISE NOTED.
 ALL DIMMING BALLASTS TO BE LUTRON ECOSYSTEM SERIES: H-LINE 1% H-LINE 1% WITH OPTICAL FACE-TO-BLACK, H-SERIES, OR H-LINE PREMIER 5% UNLESS OTHERWISE NOTED.
 E.E. TO CONFIRM ALL CIRCUITING REQUIREMENTS.
 ARCHITECT TO VERIFY QUANTITY, LOCATION & FINISH OF ALL CONTROLS.
 LUTRON FIELD SERVICE COMMISSIONING INCLUDED IN ALL SYSTEMS EXCEPT 40 YEAR LIMITED WARRANTY. THE ELECTRICAL CONTRACTOR MUST CONTACT LUTRON (1-844-566-7461) TO SET UP VISIT WITH 10 DAYS NOTICE.

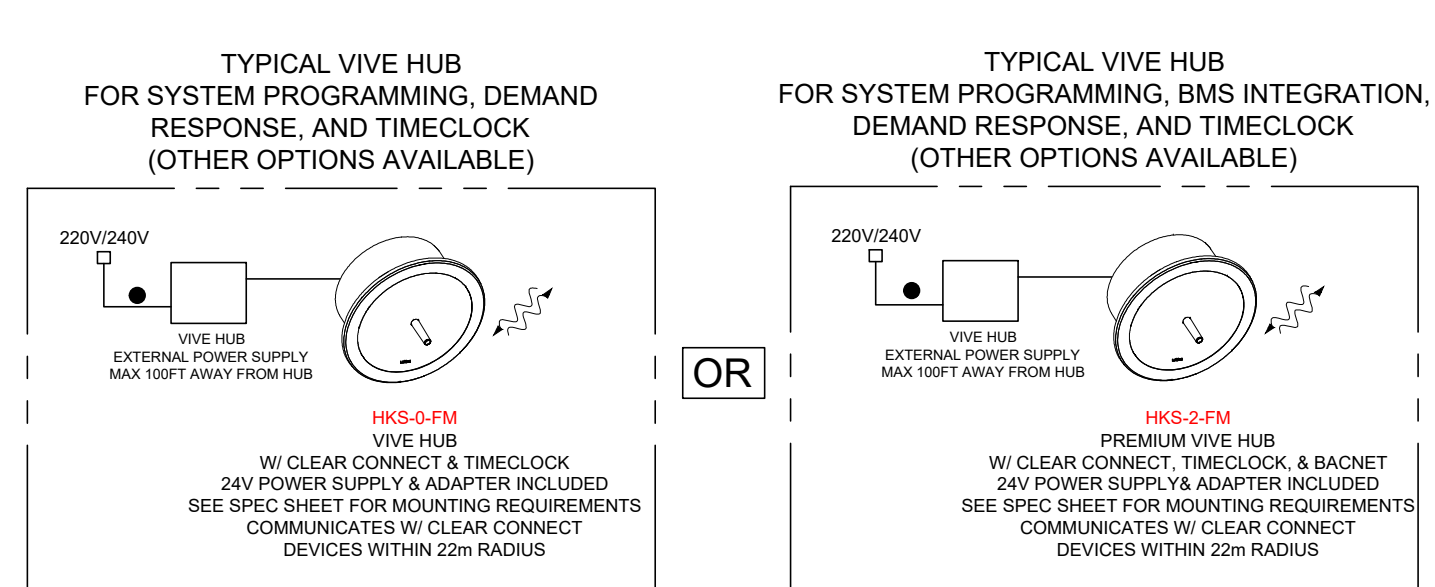
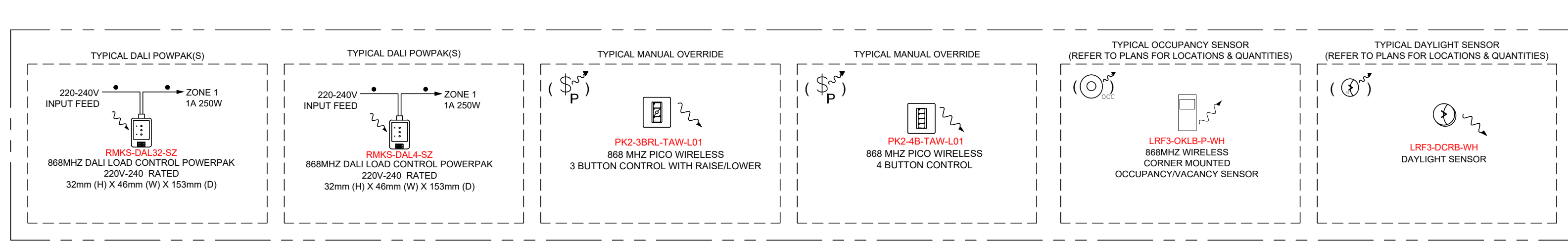
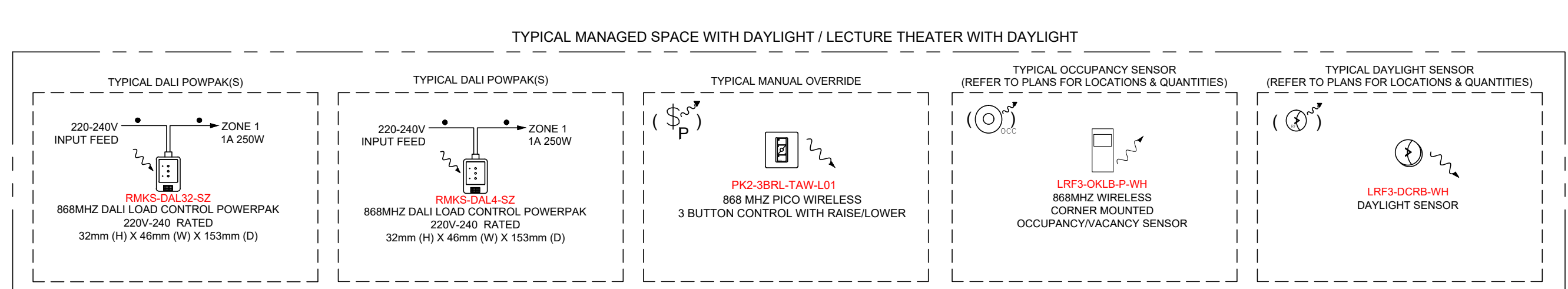
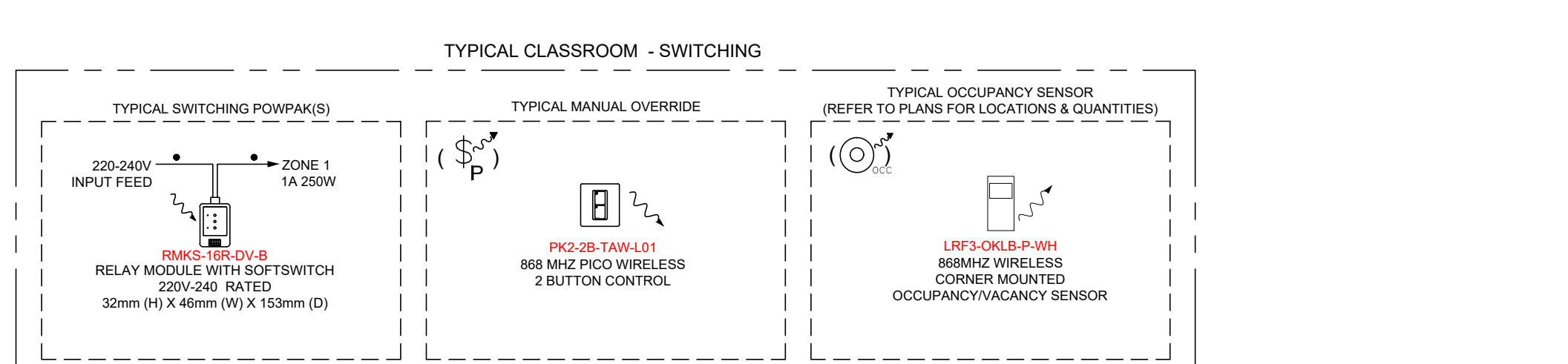
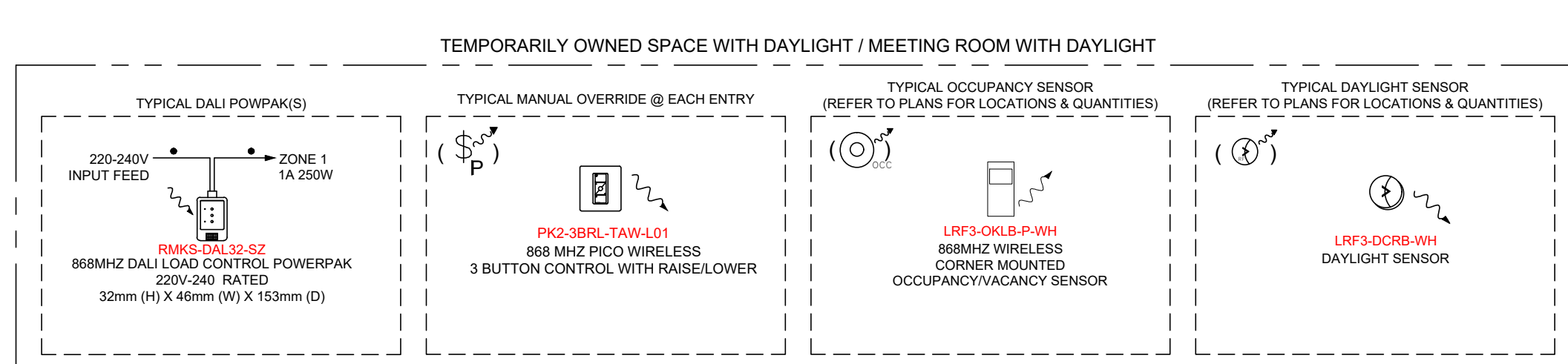
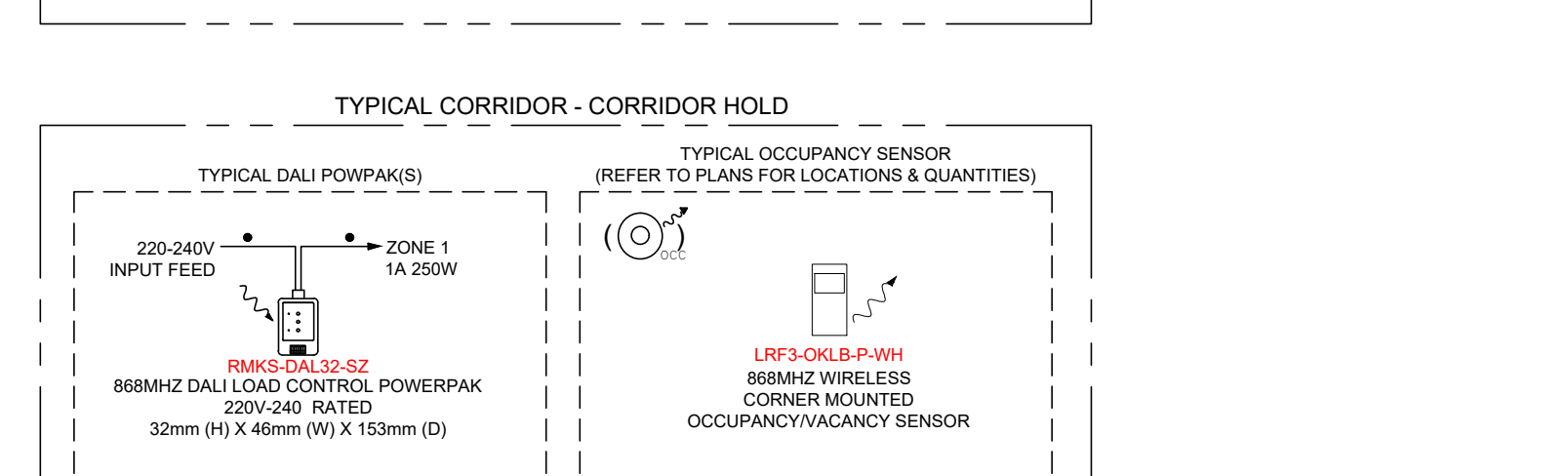
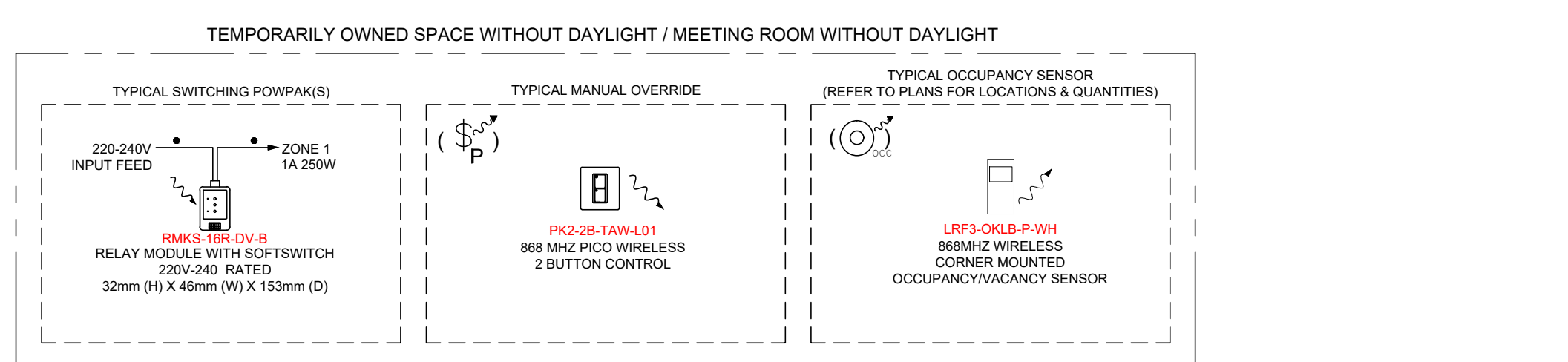
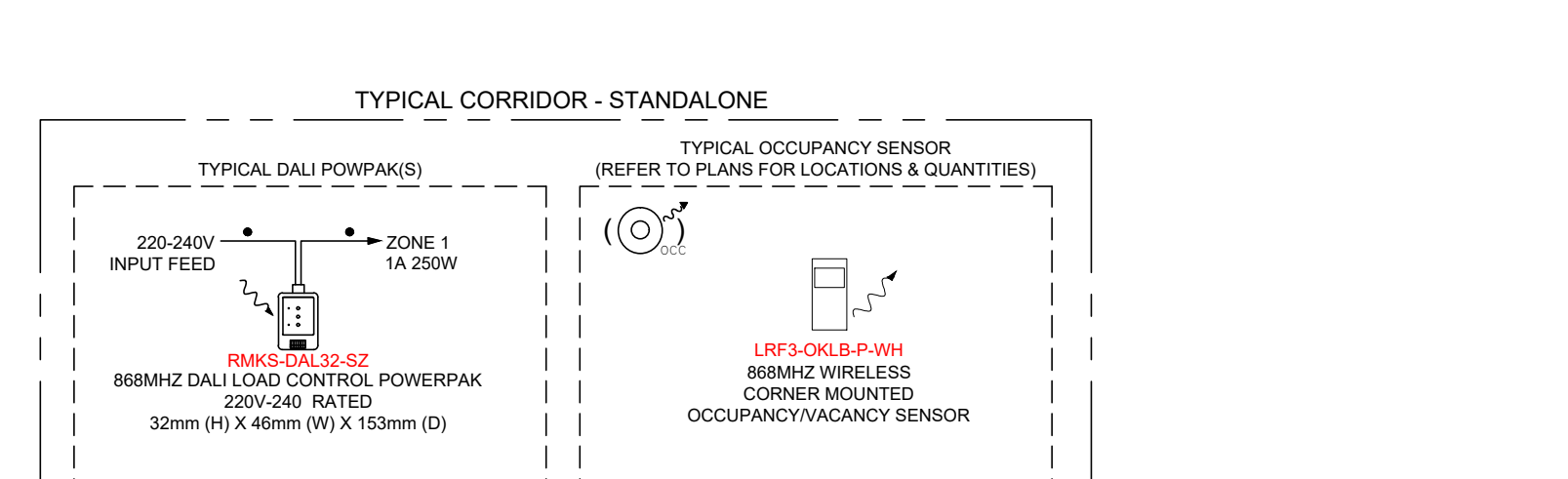
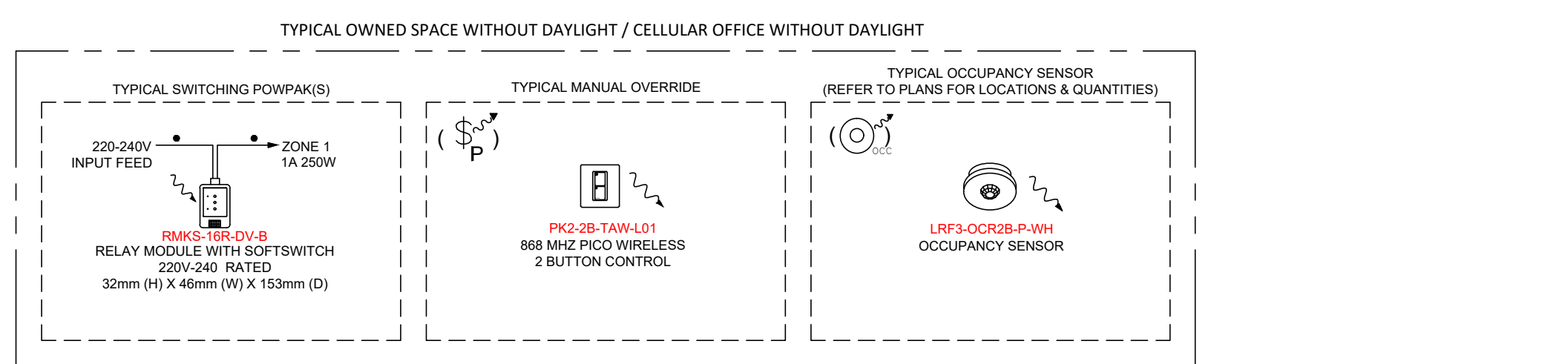
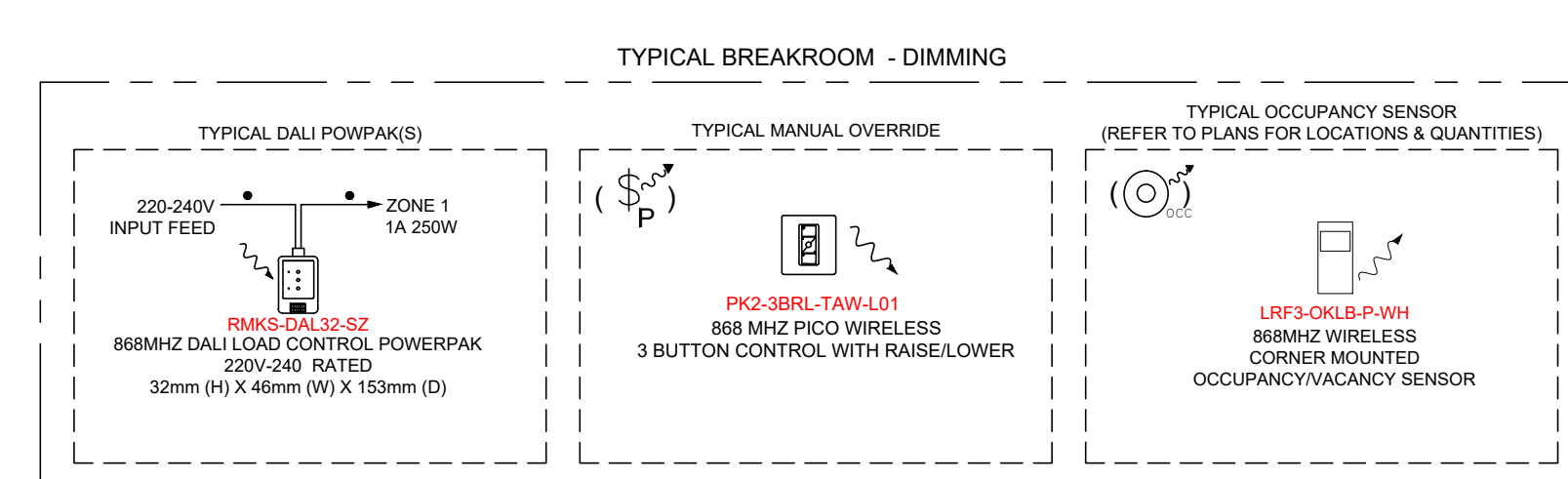
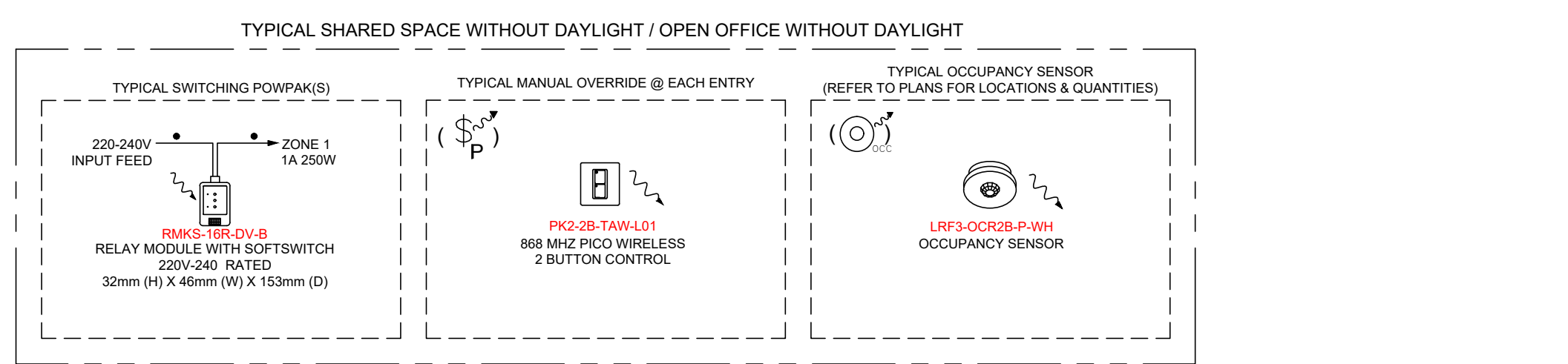
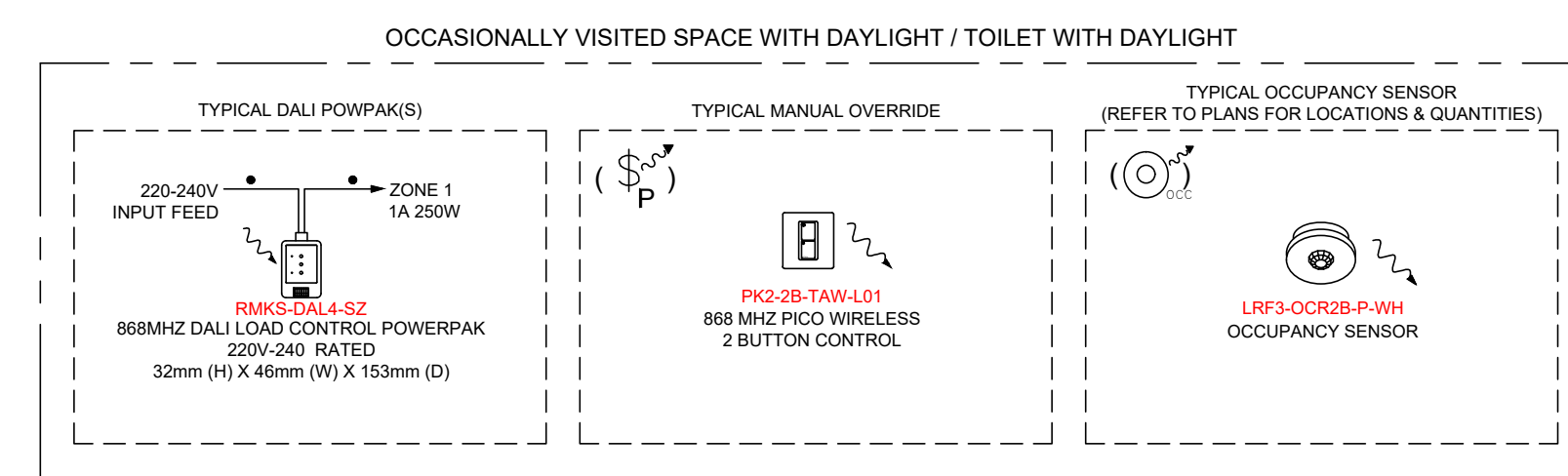
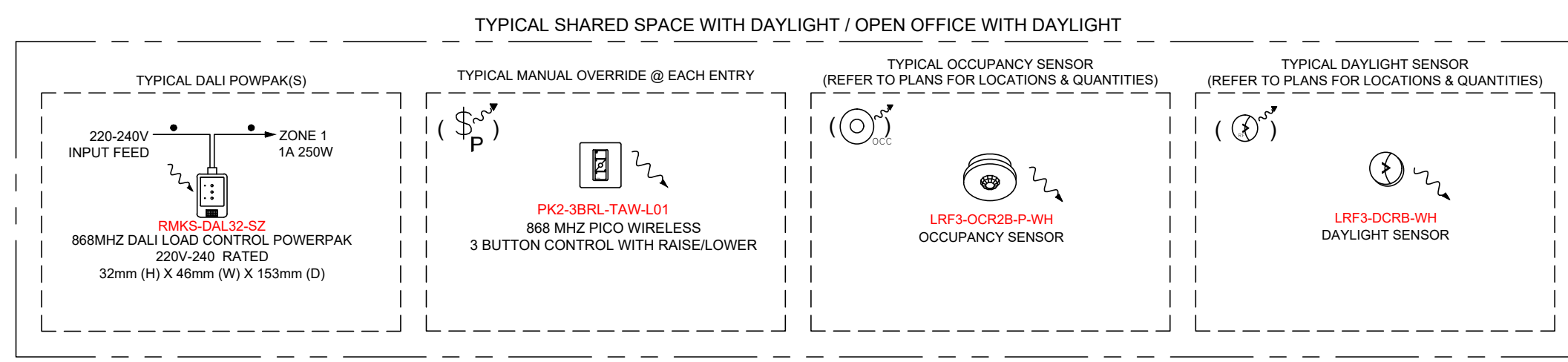
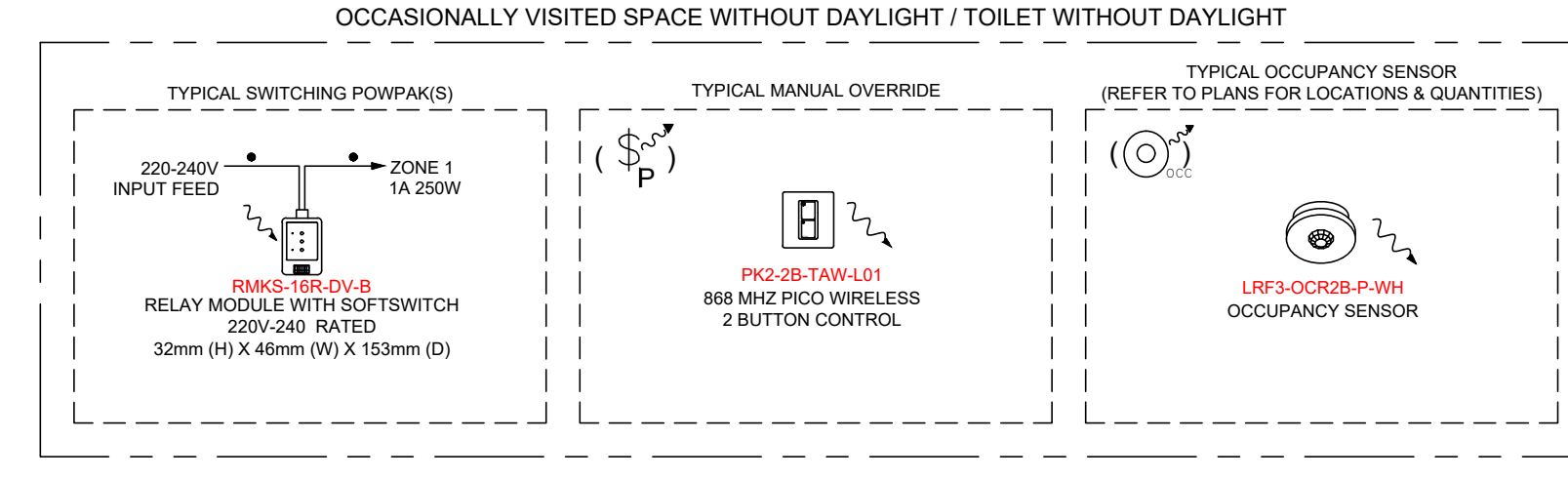
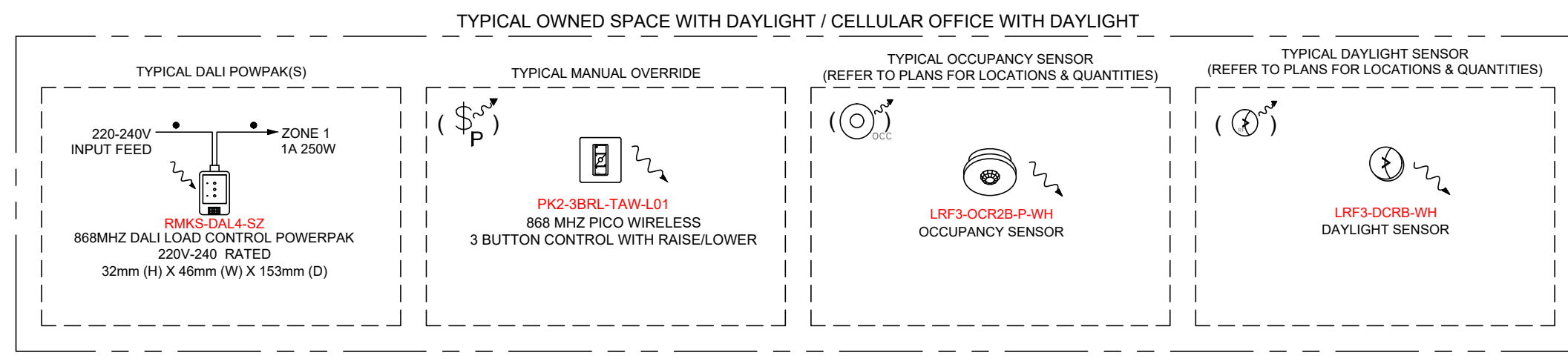

WIRING LEGEND:
 ○ INPUT POWER (NORMAL)
 ● 4-wire
 ○-10V / DALI SIGNAL: 1-wire
 ○-2-WAY RF COMMUNICATION
 ○-1-WAY RF COMMUNICATION
 ○-2-WAY RF COMMUNICATION

SYMBOL LEGEND:
 ○ WIRELESS DAYLIGHT SENSOR
 ○ WIRELESS VACANCY SENSOR
 ○ WIRELESS OCCUPANCY SENSOR
 ○ WIRELESS RECEPTACLE
 ○ WIRELESS ZONE KEYPAD
 ○ WIRELESS SCENE KEYPAD

WIRELESS KEYPADS:
 A. DOES NOT REQUIRE EXTERNAL POWER PACKS, POWER OR COMMUNICATION WIRING.
 B. ALLOWS FOR EASY REPROGRAMMING WITHOUT REPLACING UNIT.
 C. INCLUDES LED TO INDICATE BUTTON PRESS OR PROGRAMMING MODE STATUS.
 D. MOUNTING:
 1. CAPABLE OF BEING MOUNTED WITH A TABLE STAND OR DIRECTLY TO A WALL.
 2. DIMMER & RECEPTACLE BACKBOX OPTIONAL.
 E. 10 YEAR BATTERY LIFE.

COUNT OF EACH SERVICE	SERVICE TITLE (MODEL NUMBER)	SERVICE DESCRIPTION
		THE QUANTITY OF SERVICES BELOW ARE TO BE INCLUDED AS PART OF THE PROJECT'S SCOPE OF WORK AND SPECIFIED INTO THE WRITTEN SPEC DOCUMENTS.
		STARTUP SUPPORT SERVICES
	STARTUP PROGRAMMING 4-HOUR BLOCK	ON-SITE SYSTEM PROGRAMMING (VIVE - UP TO 4 CONTINUOUS HOURS OF SYSTEM PROGRAMMING DELIVERED BY A LUTRON SERVICE REPRESENTATIVE. THE SYSTEM WILL BE PROGRAMMED FOR AN APPROVED SEQUENCE OF OPERATION. QUANTITY INDICATES THE NUMBER OF 4-HOUR VISITS PURCHASED).
	WIRELESS PROGRAMMING 4-HOUR BLOCK	ON-SITE SYSTEM PROGRAMMING (VIVE - UP TO 4 CONTINUOUS HOURS OF SYSTEM PROGRAMMING DELIVERED BY A LUTRON SERVICE REPRESENTATIVE. THE SYSTEM WILL BE PROGRAMMED FOR AN APPROVED SEQUENCE OF OPERATION. QUANTITY INDICATES THE NUMBER OF 4-HOUR VISITS PURCHASED).
	WIRELESS PROGRAMMING 4-HOUR BLOCK	ON-SITE SYSTEM PROGRAMMING (VIVE - UP TO 4 CONTINUOUS HOURS OF SYSTEM PROGRAMMING DELIVERED BY A LUTRON SERVICE REPRESENTATIVE. THE SYSTEM WILL BE PROGRAMMED FOR AN APPROVED SEQUENCE OF OPERATION. QUANTITY INDICATES THE NUMBER OF 4-HOUR VISITS PURCHASED).

PLEASE GO TO WWW.LUTRON.COM/SERVICES FOR FURTHER INFORMATION.

TYPICAL VIVE SYSTEM

CONCEPT DRAWING NOT FOR CONSTRUCTION

Project Number: N/A
 Drawn By: XXX
 Drawing Revision: X
 Drawing Date: XX-XX-XXXX
 Sheet: 1 OF 1

